

**A TAXONOMIC REVISION OF BULBOPHYLLUM,  
SECTIONS ADELOPETALUM, LEPANTHANTHE, MACROURIS, PELMA,  
PELTOPUS, AND UNCIFERA (ORCHIDACEAE)**

J. J. VERMEULEN

Rijksherbarium / Hortus Botanicus, Leiden, The Netherlands  
(Drawings by the author)

CONTENTS

Summary .....	2
1. Introduction .....	2
2. Taxonomic history of <i>Bulbophyllum</i> in Southeast Asia .....	3
3. Materials and methods .....	3
4. Species concept .....	4
5. Terminology .....	5
6. Notes on the morphology of <i>Bulbophyllum</i> .....	5
7. A cladistic analysis of the revised sections .....	7
7.1. Introduction .....	7
7.2. The preferred computer program .....	8
7.3. Some aspects of the followed procedure .....	9
7.4. A priori assumptions for this analysis .....	13
7.5. The analyses .....	18
7.6. The phylogenetic relationship between the sections .....	43
7.7. Discussion .....	44
8. A biogeographical analysis of the revised sections .....	47
8.1. Introduction .....	47
8.2. Recognition of areas of endemism in New Guinea .....	48
8.3. Coinciding species ranges and geotectonic blocks in and around New Guinea .....	54
8.4. Ad-hoc explanations regarding observed patterns .....	58
8.5. Areas of endemism elsewhere .....	60
9. Cultivation .....	60
10. Acknowledgements .....	61
11. References .....	62
12. Revisions — <i>Bulbophyllum</i> .....	64
Key to the sections revised in this volume .....	64
Section <i>Adelopetalum</i> .....	66
Section <i>Lepanthanthe</i> .....	73
Section <i>Macrouris</i> .....	89
Section <i>Pelma</i> .....	121
Section <i>Peltopus</i> .....	145
Section <i>Uncifera</i> .....	176
13. Identification list .....	187
Legends to Figures 26–141 .....	192
Figures 26–141 .....	203
Index .....	319
Legends to the plates .....	323
Plates 1–6 .....	

## SUMMARY

A revision is presented of six sections of the genus *Bulbophyllum* (Orchidaceae): sect. *Adelopetalum* (mainly occurring in Australia), sect. *Lepanthanthe*, sect. *Macrouris*, sect. *Pelma*, sect. *Peltopus*, and sect. *Uncifera* (all mainly occurring in New Guinea). Together these include 110 species and 9 subspecies. Forty-seven species and 4 subspecies are new; they are either described in this revision or in precursors to this revision. The genus *Dactylorhynchus* is reduced to *Bulbophyllum*. Keys to the species, as well as synonymy, descriptions and illustrations of each species are provided. Some aspects of the morphology of the plants are discussed. A cladistic analysis of each revised section is given. A method to select the closest outgroup species from a number of possibilities is developed; this method is applied here to hypothesize the phylogenetic relationships between the sections. A biogeographical analysis of the New Guinean species is attempted but fails, because most species show overlapping ranges. Nevertheless, observed resemblances between species ranges and the outline of land masses which played a role in the geotectonic history of the island allow a conjectural scenario for the evolutionary history of *Bulbophyllum* in the area.

*Key words:* Orchidaceae, *Bulbophyllum*, East Malesia, New Guinea, Australia, cladistics, biogeography.

## 1. INTRODUCTION

In this volume a revision is presented of six sections of the genus *Bulbophyllum* (subtribe *Bulbophyllinae*, tribe *Epidendreae*). Five of these mainly occur either in New Guinea, and in the surrounding archipelagos West, North and East of this island: sect. *Lepanthanthe*, sect. *Macrouris*, sect. *Pelma*, sect. *Peltopus*, and sect. *Uncifera*. The sixth, sect. *Adelopetalum* is almost confined to Australia.

The sections to be revised have been selected so that five of them share an almost unique, albeit polythetic set of characters (i.e. a set of characters occurring in a majority of the species of a group; see Geesink, 1987: 77) within *Bulbophyllum*: "inflorescence racemose; node between rachis and pedicel not in the axil of the subtending bract, but shifted in the direction of the flower." Elsewhere within *Bulbophyllum* this combination is found in some New Guinean species of sect. *Intervallatae* (sensu Vermeulen, 1991: 151; this section is distinct in having the polythetic character: one flower open at a given time), in sect. *Pachyanthe* from New Guinea (Schlechter, 1913: 750; characterized by large flowers with a verrucose lip), as well as in two Bornean species of sect. *Hirtula*: *B. jolandae* J.J. Vermeulen and *B. rariflorum* J.J. Smith (see Vermeulen, 1991). The species of the sixth section, sect. *Peltopus*, all have 1-flowered inflorescences. The section had to be added because it shares a number of unique characters (foot of the column with a tooth or a knob immediately above the ligament; lip with a cavity at its base in which this lump fits) with sect. *Pelma*. Presumably the two together constitute a monophyletic group.

The sections have also been selected in such a way that a number of them can be regarded as monophyletic (because they have sets of unique characters), while the others are likely to contain the outgroup species of the monophyletic sections.

The grouping of the New Guinean species into sections in this volume is derived from Schlechter (1913). Although Schlechter presented an admirably comprehensive enumeration of the many hundreds of new species he found, his work falls short as a reliable foundation for revisions for several reasons. Schlechter's sections are often based on a few characters which he regarded *a priori* as diagnostically important. He tended to pay much less attention to other characters. He also showed an inclination to exile aberrant species to separate sections or even separate genera, overlooking the characters which would justify

their inclusion in existing sections. An example of this is *Bulbophyllum latipes* J.J. Smith (sect. *Pelma*), which was split off by Schlechter as the genus *Dactylorhynchus*. From the cladistic analysis (see Chapter 6) it appears that the unique characters of this species which caused its recognition as the type of a new genus, are better regarded as autapomorphies within sect. *Pelma* of *Bulbophyllum*. Schlechter's methods of working also led to the misplacement of a small percentage of his species. For the present revision, these 'stowaways' had to be tracked down. This was a time-consuming affair. It involved the analysis of a large number of type specimens, because characters now considered to be diagnostic, but not observed by Schlechter, did not feature in the original species descriptions. A good source of misplaced species proved to be Schlechter's sections *Cycloglossum* and *Micromonanthe*, both containing species which he could not include elsewhere.

Schlechter also arranged his sections into subgenera, thus suggesting phylogenetic relations between sections. I prefer to postpone a hierarchical grouping of the sections of *Bulbophyllum*, with its possibly ensuing nomenclatural consequences, until estimated phylogenetic relationships between all the sections are available, inferred from cladistic analysis. This will only be possible after revision of the entire genus.

## 2. TAXONOMIC HISTORY OF BULBOPHYLLUM IN SOUTHEAST ASIA

The generic name *Bulbophyllum* was first used by Du Petit Thouars (1822). At a later date it was conserved against an older name (see Vermeulen, 1987: 2). The East Malesian species of the genus remained largely unknown during the nineteenth century. Only in the first decades of the twentieth century, adventurous botanists started exploring the interior of New Guinea. They discovered an almost unequalled wealth of orchid species, among which they found hundreds of species of *Bulbophyllum*. The documentation of this cornucopia was mainly the work of three taxonomists: H.N. Ridley (1916), R. Schlechter (1911–1914) and J.J. Smith (1911–1935). Although some collecting continued in at least a part of the area after the Second World War, the taxonomic work was not taken up again. The above mentioned authors all preferred to keep *Bulbophyllum* as a single, extremely speciose genus. Only comparatively small groups have been split off as separate genera. Their generic status is disputed (see, for instance, Seidenfaden, 1973). In this volume the monotypic genus *Dactylorhynchus* Schltr. has been included in a section of *Bulbophyllum*.

## 3. MATERIALS AND METHODS

*Materials* — This revision is partly based on the herbarium specimens and liquid-preserved samples already stored in a number of institutions. In addition, a large number of specimens (approx. 3000 spirit samples of *Bulbophyllum* species from all over the world in some 10 years) have been collected especially for the revision of the genus, either by persons living in countries where the genus is native, or by persons or institutions growing the plants. These newly acquired collections have added much information to the revision because of their often excellent quality and completeness.

*Preparation of the materials and the plates* — A spirit sample was analyzed of each species to survey the characters, as well as to make analytical sketches. All other spirit samples as well as the herbarium material were compared with these samples. Where no spirit

material was available of a species, a first analysis was based on an herbarium specimen of which flowers were soaked in water, methylated spirit, ammonia or a NaOH-solution.

Precautions were taken not to cause unnecessary damage to the material, particularly when using the latter two very aggressive solvents. A flower was always boiled in water first. Then, all the flower parts sticking together due to the drying process were gently prised apart. The flower was only then soaked in spirit and, if this was not effective, in a hot alkaline solution. This was preferably done 'au bain marie' (in a larger vessel containing water) to prevent boiling, which would destroy the flower. If flowers were selected which were properly dried (quickly, without moulding or decaying, and without excessive flattening) the flower parts recovered their natural shape up to a reasonable extent.

Generally, the drawings of the flowers and the floral parts have been prepared with a Wild stereo microscope with a 'camera lucida' device. Ample corrections were almost always necessary because of distortion or oblique flattening, irrespectively whether the flowers were examined fresh, pickled in spirit, or as boiled herbarium material.

*Preparation of the revision* — Compared to the revision of the Continental African *Bulbophyllinae* (Vermeulen, 1987), the revision presented in this volume is much more concise. This is because the act of revising an extremely speciose genus such as *Bulbophyllum* demands seeking an optimal routine, i.e. a balance between speed and thoroughness. This optimum moves between narrow boundaries. Treading beyond these boundaries would cause either gross incompleteness, or a waste of time on comparatively small improvements. The quality of a revision is largely determined by a careful delimitation of the recognized species (avoiding mistakes such as overlooking an easily recognizable species and including its characters in one or more other species), as well as by the usefulness of the keys. It is therefore advisable not to try speeding up the preparation of these parts of a revision. In some aspects, however, time can be saved: 1) Complex species or species complexes, located and delimited during the revision, can be circumscribed as a whole if they cannot be unravelled successfully in a reasonable period of time. However, the patterns of variability within the complex should be described extensively in notes. 2) The amount of literature cited. Only the original reference for each name is given here. Misidentifications in other literature are only cited if misconceptions are involved; incidental misidentifications are ignored.

Reducing the length of descriptions hardly saves time. To a large extent they are computer generated, either automatically abstracted from data matrices, or obtained by deleting character states from a generalized form in which all possibilities are mentioned.

#### 4. SPECIES CONCEPT

Because the reconstruction of the phylogenetic relations between the revised species is attempted by means of cladistic analyses, the evolutionary species concept (sensu Wiley, 1981: 24) is used as a conceptual basis. His definition of a species reads: "a single lineage of ancestor-descendant populations which maintains its identity from other such lineages ...". If a lineage maintains its identity, it will also develop characters. Characters also serve to distinguish species.

In a classification the species should be delimited in such a way that they coincide as much as possible with these lineages.

Classifications should also apply to all the material studied: all specimens should be classified unequivocally. This leads to the following technical criteria to delimit species: species are to be recognized by at least two independent characters, and species are separated by morphological discontinuities from similar species.

If two species were found to differ in only a single character, the two have been considered conspecific. A single difference is more likely to denote variability within one species than the presence of two.

If a morphological continuum was found between two recognized species, the two have been considered conspecific because, otherwise, the intermediates could not be classified unequivocally. If, however, only incidentally an intermediate turned up, these have been regarded as interspecific hybrids.

The evolutionary species concept leaves little room for subspecific entities. Practical considerations, however, make distinction of subspecies useful to cater for cases where, because of the material available, no decision can be made whether two species are involved or only a single. Subspecies have not been used as operational units in the cladistic analyses because they are considered as artificial entities (classes, in the sense of Zandee & Geesink, 1987: 132) within a species: their components only have the distinguishing character in common. They are not thought of as lineages as meant in the evolutionary species concept; this in spite of the fact that the observed variability within a species, which caused the recognition of subspecies, could mark a splitting event in progress within a lineage.

## 5. TERMINOLOGY

In general, the terminology of Vermeulen (1987: 8, figs. A, B, C) has been applied to prepare the descriptions for this volume. However, the terminology to describe the shape of leaves and flower parts has been altered to some extent. Only four terms have been used here: obovate, elliptic, ovate, triangular. The index: 'length of a part divided by its width', is given as a number.

## 6. NOTES ON THE MORPHOLOGY OF BULBOPHYLLUM

The morphology of orchids is described extensively in Dressler (1981: chapter 3). The general morphology of *Bulbophyllum* is included there. Only a few aspects need some more explanation.

*The inflorescence* — Inflorescences such as occur in *Bulbophyllum* are often described as 'lateral' (Dressler, 1981: 38), as opposed to the 'terminal' inflorescences of, for instance, the genera *Calanthe* or *Liparis*. Although this terminology is sufficiently clear for species descriptions, it is in fact not entirely correct. Basically, the growth habit of orchids can be described as a succession of sympodial shoots. Each one arises from a node of the previous shoot, and consists of a stem with leaves. The uppermost leaves bear an axillary flower. Numerous variations exist on this pattern. A morphological differentiation in sterile and fertile shoots is very common. This occurs in, e. g., the genus *Tainia* (Turner, 1992), where plants consist of sterile shoots bearing a number of large leaves, alternating with fertile shoots. In the fertile shoots the leaves are reduced to scales, and the upper scales have flowers. In *Bulbophyllum* the differentiation has progressed even further: the fertile shoots

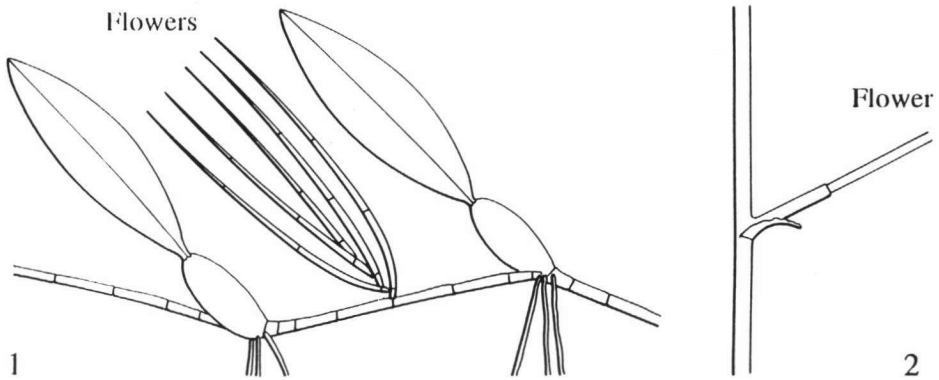

Fig. 1. A succession of fertile shoots, arising from a sterile one, and together forming a short sympodium.  
 Fig. 2. Shifting of the node between the rachis and the pedicel.

are not intercalating with the sterile shoots, but they are sidetracked, and generally die back entirely after anthesis. In some cases, however, a succession of fertile shoots may grow from a sterile one, together forming a short sympodium, see Figure 1. This differentiation occurs rather frequently in species with a single-flowered inflorescence, particularly in those having small flowers. Very rarely, however, it occurs in species with a racemose inflorescence. The most conspicuous examples are included in the present revision: bushy tufts of inflorescences are found in *B. cruttwellii*, *B. inquirendum*, *B. lepanthiflorum*, and *B. leptophyllum*, of sect. *Lepanthanthe*.

**Displacement of floral bracts** — Almost all species of *Bulbophyllum* with a single-flowered inflorescence show the following feature, see Figure 2: the node between the peduncle and the pedicel does not coincide with the subtending bract. Apparently the node has moved up to a few millimetres in the direction of the flower, because an abortive second flower, which is generally present, emerges from the floral bract, rather than from the node. In *Bulbophyllum* species with a racemose inflorescence, this feature is almost restricted to the sections *Lepanthanthe*, *Uncifera*, *Macrouris*, and *Pelma*, revised in this volume. Other orchids showing this character can be found in the subtribe Pleurothallidinae.

**Unique structures in flowers that are probably pollination-related** — In the flowers of the species revised in this volume, a number of features occur which are unique, or nearly so, within the *Bulbophyllinae*. Although no direct observations have been made of pollinators, these features are likely to be a part of more or less specialized pollination systems of the species on which they occur. The most conspicuous are listed below.

- 1) Stick-like, incurved protuberances on the sepals of the species of sect. *Lepanthanthe*. The tip of the sepals is often swollen, and may have a somewhat papillose or colliculate surface. The possibility exists that this is pseudo-pollen. However, standing in a triangle around the column and the lip (see the plate of *B. erinaceum*) the protuberances may also act as a buffer to guide the pollinator into the right direction.

- 2) A conspicuous lump on the foot of the column, immediately above the ligament, of most species of sect. *Pelma* as well as *Peltopus*, with a corresponding cavity at the base of the lip. This seems to serve an obvious goal: to partly or entirely immobilize the lip. In numerous species of *Bulbophyllum* the lip is highly mobile and acts as a trap to bring pollinators into contact with the pollinia. In most species of the above mentioned sections the lip is more or less immobile and can only be forced down, often with some damage to the flower. A remarkable structure in sect. *Hapalochilus* (also mainly from New Guinea) serves the same end: the foot of the column and the base of the lip are fused, rendering the lip equally immobile.

## 7. A CLADISTIC ANALYSIS OF THE REVISED SECTIONS

### 7.1. Introduction

While performing a cladistic analysis of the sections revised in this volume, two major obstacles have been met with :

- 1) The rule of parsimony dictates the number of a priori assumptions to be kept to a minimum. Theoretically this would compel one to analyze groups of species that are as large as possible, because a division of a group into subgroups entails an a priori statement as to the phyletic status of each separate subgroup. In the final composite cladogram of the group, such subgroups would be found back as branches which carry a group of species of a priori fixed composition. Unfortunately the present-day computer programs perform best when confronted with a limited number of species only (at the most some 25 species). Presumably this has to do with the fact that, sooner or later, most characters will show homoplasies. The larger the group under analysis, the greater the chance that so many characters show homoplasies that the phylogenetic relationship between the species is beyond reconstruction. The number of species to be included in the analysis here is over 100, and the a priori designation of subgroups is justified by its inevitability.
- 2) A group of species considered for a cladistic analysis should be monophyletic. For all the species that are revised together in this volume, monophyly cannot be assumed. This, again, justifies a division in assumedly monophyletic subgroups.

The recovery of the phylogenetic relationships between the subgroups is likely to be hampered by the fact that the subgroups are designated a priori. This will considerably pre-determine the topology of the final overall cladogram.

To circumvent these obstacles as much as possible, a careful outgroup designation is important. This may minimize the possible adverse effects of the heavy load of a priori assumptions on the results of the analysis. It may also facilitate the estimation of the phylogenetic relationships between the subgroups. A standardized procedure to select the most likely immediate outgroup species, out of a number of candidate species, is to be preferred over a more intuitive approach. Such a procedure is devised in this chapter. It exploits a property of the computer program for cladistic analysis, HENNIG86, used here, namely the fact that it depicts the basal node of the resulting cladograms always as a trichotomy. By applying this procedure, the final choice of a most immediate outgroup species is less arbitrary, although of course its quality will always depend on an a priori selection of candidates.

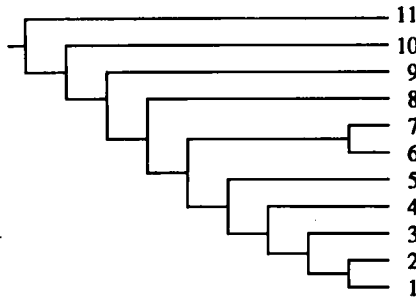

Fig. 3. The recognition of the monophyletic group containing the species 1 to 7 results in the automatic creation of a paraphyletic 'tail' containing the species 8 to 11.

A number of paraphyletic subgroups (paraphyletic 'tails') are often created automatically with the designation of assumedly monophyletic subgroups; see Figure 3.

These subgroups, too, must be analyzed. To compensate for the missing terminal branches, the lowermost species of the monophyletic subgroup (species 5 in Fig. 3) is added to the data-matrix of the paraphyletic subgroup. If it is likely that other groups than those revised also have their root in the paraphyletic subgroup, an arbitrarily chosen species of each such group is added. Such groups that are not revised present an insoluble problem. Not only is their phylogeny unknown, but their phyletic status as well. This means that, if added to a data-matrix, they may either be a monophyletic terminal branch in relation to the group under analysis, or a paraphyletic tail containing the most immediate outgroup species of that group. With the information available at present it is not possible to find out which is the most likely of the two options. As a consequence, the cladogram of the paraphyletic group under analysis has to remain unrooted; this has happened below with sect. *Macrouris*.

## 7.2. The preferred computer program

Currently, three different computer programs are in common use for cladistic analysis: CAFCA (Collection of APL Functions for Cladistic Analysis; Zandee, 1987, 1988), PAUP (Phylogenetic Analysis Using Parsimony; Swofford, 1985) and HENNIG86 (Farris, 1988). CAFCA uses group-compatibility (Zandee & Geesink, 1987). Although it has the advantage that it does not need an a priori choice of an outgroup, it is unsuitable as a means of reconstructing a phylogeny, because its innate inability to cope with character reversals is considered insuperable (Van Welzen, 1990: 55). PAUP and HENNIG86 use the Wagner-algorithm (see Brooks, 1984) for constructing cladograms, followed by branch swapping ('branch and bound') if desired. They do need an a priori designated outgroup, but have a larger capacity for reconstructing a phylogeny in spite of a considerable number of homoplasies.

Because it is by far the fastest, and least inclined to produce large series of minimally different cladograms (Van Welzen, 1990: 54) HENNIG86 has been applied here (version 1.5). As options are used: 'mhennig' (construction of one or more initial cladograms) and 'bb' (branch and bound). More extensive search procedures (such as 'ie') have not been applied, because they are more time-consuming, while generally not producing more, or



more parsimonious cladograms. If an analysis results in more than one most parsimonious cladogram the procedure is amplified with one or more character-weightings (with the options 'xsteps w' followed by 'bb'). This awards a weight to each character in such a way that the influence of the worst fitting characters is reduced:

$$w = (ci / ri) \times 100$$

in which *ci* is the consistency index and *ri* is the retention index (for both see Farris, 1989). Character-weighting is continued until either one cladogram remains, or until the allotted weights do not change any more.

Nothing is known about the ontogenetic development of the characters used in the analysis. Therefore ontogeny could not be used to designate ordered transformation series a priori.

Some characters used during the analysis are not present in the species descriptions of the revision. These characters are needed for the cladistic analysis, but not needed to distinguish between the species.

### 7.3. Some aspects of the followed procedure

To enable comparison of the various cladograms, the method of analysis should apply the same standard to all groups as much as possible. A few aspects of the procedure followed in this volume need some further explanation.

*Selection of the possible immediate outgroup species* — Species used as an outgroup should display a fair degree of overall similarity with at least a number of species of the ingroup, but they should not possess the synapomorphies of the ingroup. The choice of outgroups is a priori. This is unfortunate, because the outgroup largely affects the results of an analysis. To partly overcome the arbitrariness of this choice the analysis of an ingroup can be performed with a number of Possible Immediate Outgroup Species (to be called: PIOS). A procedure is then needed to select the species which is closest to the ingroup.

*Shuffling outgroups* — Because the basal branch in a cladogram obtained with the program HENNIG86 is depicted as a trichotomy (although the complete output contains the necessary information to resolve this trichotomy), two or three added PIOS optimally allow the program to select the best fitting one as the immediate outgroup. Four or more added PIOS offer the program an opportunity to arrange them in various ways. This is not relevant for the solution of the ingroup and only adds to the number of possible cladograms. If only two PIOS are added, the lowermost ingroup species is part of the basal trichotomy, and additional computer output is needed to find out which of the two PIOS fits best. Whenever available in sufficient numbers, PIOS have therefore been added in sets of three to the matrices to be analyzed.

If the three PIOS are brought to bear simultaneously as outgroup (rather than each separately in three different runs), the basal part of the cladograms resulting from analysis with HENNIG86 is generally as in Figure 4.

Here, it is clear that the computer program has selected PIOS 3 as the most immediate outgroup species. Sometimes, however, the cladograms obtained seem incongruous with the input: despite the fact that the three PIOS have been indicated simultaneously as out-

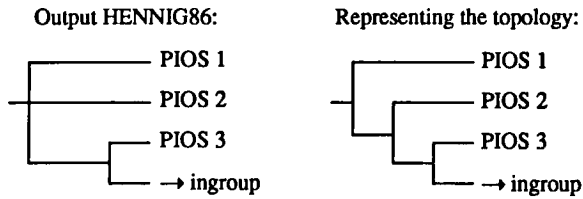

Fig. 4. PIOS applied in sets of three to an ingroup. The most frequently occurring topology of the basal part of the cladograms resulting from analysis with HENNIG86, with all three PIOS simultaneously appointed as outgroup (N.B.: HENNIG86 depicts the species in a polytomy in alphabetic order).

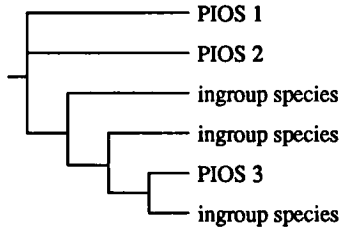

Fig. 5. PIOS applied in sets of three to an ingroup. An occasionally occurring topology of the basal part of the cladograms resulting from analysis with HENNIG86, with all three PIOS simultaneously appointed as outgroup. PIOS 3 is included here in the ingroup.

groups, one or two PIOS are included in the ingroup, while ingroup species take their places at the root of the cladogram, see Figure 5.

Technically, this is due to HENNIG86 ignoring the command to keep the three PIOS as outgroups if scattering one or two of them among the ingroup species results in more parsimonious cladograms. It then takes only the first PIOS as outgroup (Van Welzen, pers. comm.). As for the phylogeny of the group under analysis, such topologies may denote PIOS which in fact belong to the ingroup, but which are not recognized as such before the cladistic analysis because they have lost the apomorphies of the ingroup. If a scattering of PIOS throughout the cladograms occurs, all three PIOS (including the one or two at the base of the cladogram, because their position is the result of an arbitrary choice only) must be critically re-examined. One (which is isolated from its fellow PIOS) or two (pairs which come out as neighbouring species in the cladogram) of them may be less suitable to resolve the ingroup on second thought: they may show many deviant characters which have not been recorded in the data-matrix, because these characters are not relevant to the solution of the ingroup. These PIOS have to be rejected. If such PIOS cannot be found, the question arises again whether or not the group under analysis is monophyletic. Possibly, one or two PIOS have to be included in the ingroup in order to obtain a monophyletic group; but then, as a consequence, the inclusion of the entire section to which the PIOS belong has to be considered. New PIOS must take their place at the root of the cladogram.

Where the number of PIOS for an ingroup is larger than three or a multiple of three, two or more sets of PIOS can be applied (see Figure 6 for a schematic representation of the following procedure). The PIOS are arranged in such a way that those within one set belong as much as possible to a single section. For each set of three the most immediate outgroup

In case more than 3 PIOS available (here: 6 PIOS from two groups, A and B):

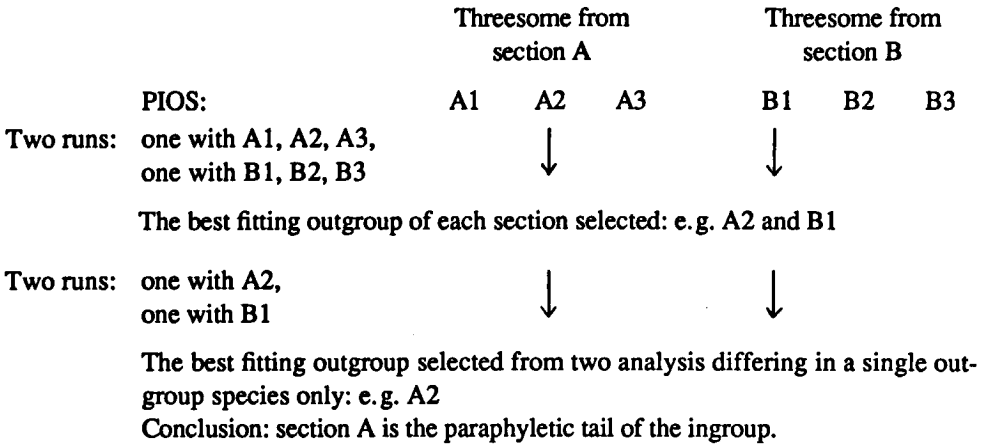

Fig. 6. A schematic representation of the procedure followed to select the most immediate outgroup from a number of PIOS.

species is selected by the method described above. However, before comparing the properties of the cladograms obtained with the various sets of PIOS, the data-matrices on which the cladograms are based have to undergo a further processing, because they differ substantially. If full sets of three PIOS were applied, the three basal taxa differ; if in one case the number of PIOS was insufficient to make up full sets of three, the total number of taxa differs, next to a number of basal taxa.

A comparison between cladograms with different sets of PIOS only makes sense if the differing properties can be attributed to one single cause. As a second step, therefore, each separate data-matrix has been stripped of the two superfluous outgroup species, and subjected again to an analysis with only the most immediate outgroup species. Provided that the cladograms now obtained show a topology similar to those obtained during the first analysis, their properties such as the number of character changes (steps), *ci*, *ri*, and topology can be compared, because they differ only in one taxon. The following criterion has then been applied to select the most immediate outgroup from the cladograms obtained in the second step: the PIOS which most parsimoniously resolves the ingroup should be regarded as the most immediate outgroup. This is an application of the parsimony rule and therefore a sound criterion.

Once a PIOS is rejected or accepted, this decision is likely to hold for the entire section to which the PIOS belongs. The section can then be rejected or accepted as the paraphyletic 'tail' of the ingroup. The chance that this does not hold is minimized by only accepting three species of the same section within a set of PIOS. Besides, if a species of another section were added to the set, this could exert undue influence on the solution of the ingroup.

Cladograms chosen as probably closest approaching the true phylogeny of a group, are depicted with their full chain of three PIOS. The two most basal PIOS are connected to the

cladogram with an interruption between arrows. The properties of the accepted cladograms given in the text, however, refer to the analysis of the ingroup with its most immediate outgroup only.

*Ambiguity as a selecting criterion* — In case two PIOS, or sets of PIOS, produce series of cladograms which are equally parsimonious, an additional criterion is needed to select the most immediate outgroup species. The following one has been used here: in case a number of PIOS resolve an ingroup equally parsimoniously, the PIOS which most unambiguously (which means here: which produces the smallest number of cladograms) resolves the ingroup is regarded as the most immediate outgroup species. This may be understood as follows: the cladogram reflecting the true phylogeny of a group can only be found if the most immediate outgroup species reconstructs this phylogeny without simultaneously producing numerous other most parsimonious cladograms. Other outgroup species, particularly the remote ones, are likely to produce less parsimonious cladograms (more steps are needed to make them fit), or to produce many alternative most parsimonious ones. The chance that a remote outgroup species will act upon the ingroup in such a way that one single cladogram is produced is small, as small as the chance that a random species will do so.

*Cutting and welding together of cladograms* — The number of species in this revision is too large to be subjected to one analysis. Even if an analysis of all species together were possible, to do so would hardly be justified, because it is not certain whether they constitute a monophyletic group. A partition will therefore be necessary. This will follow the division into sections. Some of these sections can be regarded as monophyletic, whereas others are thought to constitute the paraphyletic 'tail' to one or more monophyletic sections. The latter will serve as a source of outgroups for the analysis of the monophyletic sections. After the analysis of the monophyletic sections, the paraphyletic sections will be analyzed with the lowermost species of the monophyletic sections added to the data-matrix to represent the entire section. The selection of the most immediate outgroup for the monophyletic sections is then subjected to a check: the lowermost ingroup species and the most immediate outgroup species should at least come out close together, if not as immediate neighbours, in the cladograms obtained.

*Division of monophyletic sections into smaller groups for analysis* — In some cases the analysis of even a section which looks promising in all aspects may unexpectedly produce large numbers of most parsimonious cladograms. If these cladograms all display only one or a few gross topologies, this failure to yield a less ambiguous solution may be caused by a small number of 'weak spots' in similar positions in all the cladograms. Such spots are prone to alternative solutions, or to a collapse into polytomies. On such occasions, the computer program may produce numerous extra cladograms with all possible combinations of solutions for these weak spots. Subsequent character-weighting does not necessarily reduce the number of cladograms.

If such is the case, a further division of the section into smaller monophyletic groups may be useful. Branches of a fixed composition but with a slightly variable topology, which occur in most of the series of most parsimonious cladograms (or in most of the first one hundred of the series) obtained by the initial analysis, may be taken out. They can be analyzed separately, following the procedure outlined above. At a later stage the remaining

species are analyzed together with the branches replaced by their most basal species. This is a way to reduce the number of weak spots per analysis, and, consequently, the number of combinations that the computer program can make. It may lead to a more unambiguous solution. After the analysis the partial cladograms can be welded together again.

'Welded points' in a cladogram represent spots where the character states are fixed ad interim. Although the position of such spots is not arbitrarily chosen, they lead to a less parsimonious composite cladogram in many cases. The fixed spots rule out a number of possible cladograms, and among them a number of (or all) most parsimonious ones. However, if the gross topology of the final composite cladogram is approximately the same as that of the initial series of slightly more parsimonious cladograms, it can still be accepted as a reasonable estimate of the phylogeny of the entire group.

This procedure to reduce the number of cladograms from which to choose, is an extension of the a priori division into manageable sections except for the fact that the groups in the first case are made ad interim, not a priori.

The 'amplification of the cladistic method' of Van Welzen (1990: 68) is a very similar device to reduce the number of possible homoplasies per analysis. It lays slightly more emphasis on the character changes supporting the branches to be analyzed separately. It can be applied successfully if so many characters are present that at least the vital branches are well supported. It is probably to be preferred, because it is in full accordance with the usual method of distinguishing monophyletic groups.

In the procedure presented here, cladogram branches to be analyzed separately have a fixed species composition, but may be variously supported by character changes in different cladograms. In many occasions, the matrices used for the analyses in this volume count barely enough characters to produce entirely resolved cladograms. It is therefore difficult to find well-supported branches; most branches will be supported by a single or very few character changes only. The procedure may in such cases offer a reasonable alternative to the method of Van Welzen.

*Rejection of cladograms as hypotheses for the phylogeny of the group* — If the PIOS which most parsimoniously resolves the ingroup still yields two or more trees with fundamentally different topologies after character-weighting, a choice cannot be made. One may invoke auxiliary criteria for selection, such as the Redundancy Quotient (Geesink & Zandee, in prep.). However, it is preferable not to use other criteria if no unambiguous results can be obtained. The cladograms are then rejected as hypotheses for the phylogeny of the group. Apparently in such cases the phylogeny of the group cannot be traced any more with the characters available.

#### **7.4. A priori assumptions for this analysis**

*Hybridization between species* — A cladistic analysis describes the phylogeny of a group as a sequence of dichotomous splitting events. If a species originates from a fusing event, such as hybridization between two species from different branches of a cladogram, this will not show in the results; it can only be surmised a posteriori. If interspecific hybridization with fertile offspring goes unchecked within a group, and causes new species to come into existence, a computer program which is based on splitting events may not be capable of reconstructing phylogenetic relationships between the species of that group.

Generally, orchids are regarded as plants which hybridize much more freely than others. This notion is supported by the fact that artificial hybrids are very easily produced, even between species which are only remotely related. Genetical barriers seem to be non-existent within groups of related species. However, this does not imply that hybrids occur in large numbers under natural circumstances; other barriers of various nature effectively prevent hybridization. Flowers with a very specialized structure occur in many species. They attract, for example, equally specialized pollinators, or they place their pollinia on the pollinator in such a position that only another plant of the same species can be pollinated (Dressler, 1981: 105). Between sympatrical sister species with a less specialized flower structure a spatial or temporal segregation may well exist: they may be confined to different micro-habitats (a spatial segregation is established to occur in ferns of the genus *Grammitis* by Parris, 1985). If their respective pollinators are equally fastidious as to ecological requirements, each of the two orchid species can still propagate as if the other did not exist.

A second point is that taxonomic work on plant families which include a comparatively large number of widely grown ornamentals among their ranks (such as Cactaceae and Orchidaceae), is partly in hands of amateurs. Instead of looking for similarities, these tend to lay an undue stress on differences between specimens, because in most cases they do not have enough material at their disposal. This often leads to an extremely narrow species concept. The narrower the species concept, the more hybridization needs to be assumed to 'explain away' the intermediates. Particularly in the European orchid flora, the subject of detailed taxonomic studies for almost two centuries now, many hybrids as well as hybrid 'swarms' are recorded in literature, for instance in the genus *Ophrys* (see Danesch, 1972). It is assumed here that an inclination to adopt an extremely narrow species concept is partly responsible for the allegedly promiscuous nature of orchids. If in orchid taxonomy a species level is maintained not diverging from the average level handled in large flora revisions, it appears that the species thus obtained are not more difficult to delimit than those in other plant families.

In the present revision it has been necessary only incidentally to consider the possibility of hybridization to explain patterns of character distribution. Examples of possible hybrids are *B. inquirendum* (see the notes under that species) and *B. imitator* (see below).

Hybridization as a major agent of speciation in orchids is ruled out here. From that point of view a cladistic analysis is possible, although the possibility that a species of hybrid origin is hidden in the ingroup should be kept in mind.

*Phyletic status of the various sections, and their possible outgroups* — An assessment is now given of the status of the sections to be analyzed, and PIOS are chosen. For the arguments on the phylogenetic relations between the sections a basic statement is necessary: all revised sections together should constitute a monophyletic group. Unfortunately not a single unique character can be found to sustain this statement. Yet most sections together (sect. *Peltopus* excepted) at least show a more or less unique combination of characters, which indicates that an immediate phylogenetic relationship may exist among them; see Chapter 1.

In addition, morphologically intermediate species exist which link all sections together. Wherever these are found, they may be seen as another indication of the existence of an immediate phylogenetic relationship among the sections thus connected. If this line of reason-

ing is followed throughout the sections revised in this volume, a few species, or groups of species, of other sections which have not been revised have to be added to those being analyzed. They represent sections which also may have their basal branch rooted somewhere in the revised sections. They are randomly chosen to obtain a monophyletic group suitable for an analysis.

The decision to treat sect. *Adelopetalum* as monophyletic needs some complicated reasoning. Within the genus *Bulbophyllum* as a whole it does not have unique characters; at best it is characterized by a very weak polythetic set. Yet monophyly can be suspected, because the species of this section show overall similarity, and occur in a rather restricted area, well away from their closest look-alikes. In order to find a stronger set of characters we may narrow our scope to the groups containing the most similar species. Two groups may serve as such:

- 1) Some species (not treated in this revision) with a racemose inflorescence which are best included in sect. *Sestochilus*, but are partially kept apart from this section by Schlechter (1911–14) as sect. *Pahudia* and sect. *Brachyostele*. Here the similarity consists of: “rhizome creeping; inflorescence a raceme; base of stigma not protruding, pollinia 4.” In this case sect. *Adelopetalum* is distinct in the following, still meagre set of characters: “plant small or medium-sized (not large); pseudobulbs ovoid, ellipsoid, or lenticular (not cylindrical).”
- 2) Sect. *Macrouris*, particularly some species of series C. The similarity can be found in the following characters: “inflorescence a raceme; base of stigma not protruding; pollinia 4.” Within these surroundings, sect. *Adelopetalum* has as a supposed apomorphy a creeping rhizome.

Two sets of PIOS have been selected from the above mentioned sections. The first is *B. spec.* (Hoogland & Craven 10899), *B. alticaule* Ridley (both from New Guinea), and *B. foetidolens* Carr (W Malesia) from sect. *Sestochilus*; the second is *B. desmotrichoides*, *B. dichotomum* and *B. imitator* from sect. *Macrouris*.

*Bulbophyllum boonjee* could not be included in the analysis, because the necessary information on this species only became available at a very late stage.

Section *Lepanthanthe* can be regarded as a monophyletic group on account of the following monothetic set: “pseudobulbs minute, inconspicuous; tip of the sepals (or at least the median sepal) a fleshy, subulate projection.” Within the genus *Bulbophyllum*, only the second character is unique. Many species of this section show a fair overall similarity, and are, morphologically, partially linked up.

Similar looking species, but not showing the above mentioned characters, can be found in sect. *Macrouris*. This section is considered as the paraphyletic root of sect. *Lepanthanthe*. From this section *B. graciliscapum*, *B. olivinum* and *B. orbiculare* have been selected as PIOS; they are morphological intermediates between the two sections.

Other species of sect. *Macrouris* incidentally show characters also occurring in sect. *Lepanthanthe*: *B. catorum* (“rhizome hanging, leaves tending to cordate”) and *B. chloranthum* (“lip with 3 keels”). However, the two species are otherwise different from sect. *Lepanthanthe* in many characters. These differences are not expressed in the data-matrix because they are not relevant to the solution of the ingroup. Both species mentioned are therefore not regarded as PIOS.

Among the sections revised in this volume, sect. *Macrouris* is characterized by the absence of the characters which are typical for the other sections. As a whole it has no apomorphies, it consists of a group of left-overs which are well recognizable on account of a number of synplesiomorphies. It cannot be regarded as a monophyletic section, as it probably contains the paraphyletic 'tails' of several other sections. Some series of species of sect. *Macrouris* constitute obvious morphological links to various other sections:

- 1) *B. olivinum*, *B. orbiculare* and *B. graciliscapum* show features which occur in sect. *Lepanthanthe*. *B. catorum* and *B. chloranthum* do so to a lesser extent (see above).
- 2) *B. imitator* is an intermediate with sect. *Uncifera* (see below).
- 3) *B. desmotrichoides* shows a few features (four pollinia, sepals with more than 3 veins) linking the section to sect. *Pelma* (see below), as well as to sect. *Adelopetalum* (see above).

These are all sections revised in this volume. However, morphological links to other sections also exist.

- 4) *B. muscicola* links section *Macrouris* to sect. *Nematorhizis*, for instance to *B. microsphaerium* Schltr., which differs mainly from *B. muscicola* in having 1-flowered inflorescences (see note under *B. muscicola*).
- 5) *B. dichotomum* is strongly reminiscent of sect. *Oxysepalum*, for instance of *B. citrinilabre* J.J. Smith or *B. sessile* (Koenen) J.J. Smith. It differs mainly in having inflorescences with two flowers.
- 6) *B. callichroma* and *B. chloranthum* show some features occurring in most racemose species of sect. *Sestochilus*: "rhizomes very long creeping, pollinia four."

The sections mentioned under 1, 2, and 3 are regarded as monophyletic themselves (sect. *Pelma* in combination with sect. *Peltopus*). They are rooted in sect. *Macrouris*, and can therefore not contain PIOS of sect. *Macrouris*. One of the sections mentioned under 4, 5, and 6 must therefore contain the most immediate outgroup species; the other two are terminal branches just as the first three sections. If one of their representatives is selected to act as the outgroup, the other two will come out scattered throughout the cladogram, as part of the ingroup, and representing an entire section. Indicating another of the three as outgroup will only lead to re-rooting the cladogram (HENNIG86 creates unrooted cladograms first, and only in the last stage makes a root with the appointed outgroup species). As a consequence, the procedure followed so far, to apply PIOS in sets of three, will never answer the question which outgroup fits best, because the data are not sufficiently complete: more information about the phyletic status of the sections mentioned under 4, 5, and 6 is necessary. The procedure is abandoned here, and the cladogram of sect. *Macrouris* is left unrooted, with three possible rooting points. Probably, one of these represents the real root of the cladogram.

Sect. *Pelma* and sect. *Peltopus* together are thought to constitute a monophyletic group on account of the following polythetic set: "foot of the column with a tooth or knob immediately above the ligament; lip with a cavity at its base in which this lump fits." This structure is unique within the genus. The tooth in the same position found in some species of sect. *Lepanthanthe* is most probably a parallel development: it is of a different shape, it does not correspond with a cavity in the base of the lip, and it is not part of a mechanism to keep the lip in a fixed position, as in sect. *Pelma* and sect. *Peltopus*. Within the group made



up by the two sections, sect. *Peltopus* is most likely monophyletic on account of the following polythetic set of characters: "petals very small or absent; stelidia entirely absent." A reduction of the stelidia to such an extent does not occur anywhere else within the genus *Bulbophyllum*. In sect. *Pelma*, the paraphyletic tail, the stelidia are generally very short and inconspicuous, but nevertheless present. The species of each of the two sections show a distinct overall similarity. A patent rhizome and a racemose inflorescence are predominant in sect. *Pelma*, a creeping rhizome and a 1-flowered inflorescence in sect. *Peltopus*.

A number of morphologically intermediate species exist which link the two sections to other sections of *Bulbophyllum*. Species of other sections which are intermediate are selected as PIOS:

- 1) Sect. *Macrouris*, series C. *Bulbophyllum desmotrichoides* ("base of stigma not protruding; sepals with more than 3 veins; pollinia four") and, to a lesser extent, *B. dichotomum* ("pollinia 2") share a number of features with species of sect. *Pelma* such as *B. colliferum* and *B. leucothyrsus*. *Bulbophyllum imitator* has been added to these two possible outgroups.
- 2) Some species of sect. *Oxysepalum* (not revised in this volume) are rather similar to *B. colliferum* and *B. leucothyrsus* of sect. *Pelma*. *Bulbophyllum sessile* (Koenen) J.J. Smith is selected as an example. Because most other species of sect. *Oxysepalum* are so similar that they would score the same as *B. sessile* in the data-matrix, two more species of sect. *Macrouris* (*B. pidacanthum* and *B. scopia*) have been added as outgroups.

*Bulbophyllum subapetalum* of sect. *Peltopus* has pseudobulbs like those of several other sections of *Bulbophyllum* ('pseudobulbs superposed': new shoots arising from the top of the old pseudobulb), such as sect. *Fruticicola*, *Epibulbon*, *Hapalochilus* or *Polyblepharon*. Since at least the latter two can be considered as monophyletic on account of a (set of) unique characters, the character 'pseudobulbs superposed' must have developed as an apomorphy in each of these sections, including sect. *Peltopus*.

As said above, a polythetic set can be found which justifies regarding sect. *Peltopus* as monophyletic. A set of PIOS will have to be found in sect. *Pelma*. *Bulbophyllum absconditum*, *B. simile* and *B. pachytelos* seem suitable. They share a 1-flowered inflorescence with sect. *Peltopus*, and they do not have the following apomorphies of sect. *Peltopus*: "rhizome creeping; petals minute; stelidia entirely reduced." The three species are morphologically linked to sect. *Peltopus* by way of *B. discolor* and *B. intersitum* of the latter section.

Finally, *B. discolor* subsp. *cubitale* has been added as an operational unit to the data-matrix, in spite of the species concepts as outlined in Chapter 3. This is because the status of this taxon is highly uncertain and it may represent a species.

Section *Uncifera* can be considered monophyletic because of the following character which is unique within *Bulbophyllum*: "stelidia with a distinct, approximately downwards directed, straight or recurved, semi-elliptic, generally rounded tooth along their lower margin, close to the tip." Probably homologous teeth but of different shape occur in several other sections.

All species of sect. *Uncifera* show a definite overall similarity.

A larger partial monothetic set can only be found when considering the section and its more restricted phylogenetic relatives only. These may be:

- 1) Sect. *Macrouris*, in particular the group *B. desmotrichoides*-*B. dichotomum*-*B. imitator* (series C). The similarity between the two groups consists of the following characters: "base of stigma not protruding from the face of the column; pollinia generally four." With this section as its immediate phylogenetic relatives the heavily polythetic character "roots along entire rhizome (not only below the pseudobulbs)" can be added as an apomorphy for sect. *Uncifera*. *Bulbophyllum imitator* in particular shows a distinct overall similarity in its vegetative parts with e.g. *B. ochroleucum* of the ingroup, and is therefore an obvious choice as outgroup. To make up a threesome the less similar *B. desmotrichoides* and *B. dichotomum* have been added.
- 2) The racemose species of sect. *Sestochilus* mentioned above, under sect. *Adelopetalum*, such as *B. alticaule* Ridley, and *B. pachyglossum* Schltr., both from New Guinea. The similarity between this group and sect. *Uncifera* consists of the characters "roots along the entire rhizome; pollinia four", both polythetic but nevertheless present in sect. *Uncifera*. Teeth along the lower margins of the stelidia, probably homologous but of different shape, frequently occur in sect. *Sestochilus*, though not in the racemose species. As outgroups the two species mentioned above have been chosen, plus an undescribed species here referred to as *B. spec.* (Hoogland & Craven 10899).

*Assumed phylogenetic coherence between the sections* — As detailed above, only the sections *Adelopetalum*, *Lepanthanthe*, *Peltopus*, and *Uncifera* are probably monophyletic. If an immediate phylogenetic relationship exists between all sections, the sections *Macrouris* and *Pelma* most likely constitute the phylogenetic link between these sections. They are the paraphyletic tails containing the PIOS to the monophyletic sections. Sect. *Macrouris* may well contain a paraphyletic tail to other monophyletic sections not revised in this volume. The assumed phylogenetic relationships between the sections as outlined above are summarized in Figure 7.

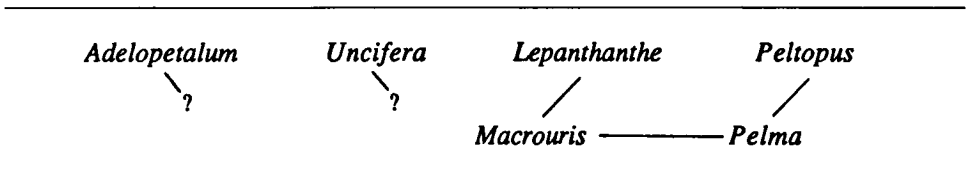

Fig. 7. Scheme indicating the a priori phylogenetic relationships between the revised sections. The monophyletic sections are in the upper row.

### 7.5. The analyses

First the assumedly monophyletic sections are analyzed.

*Analysis of sect. Adelopetalum* — The characters which have been used for the analysis of sect. *Adelopetalum* are given in Table 1.

Table 1. The characters used for cladistic analysis of *Bulbophyllum* sect. *Adelopetalum*.

1 – Rhizome:	6 – Ovary:
1: creeping	1: glabrous
2: hanging	2: verrucate
2 – Roots, growing from:	7 – Petals, number of veins:
1: all the nodes	1: one
2: below the pseudobulbs only, including the most recently developed ones	2: more than one
3: below the pseudobulbs only, but not the most recently developed ones	8 – Lip, lateral lobes:
3 – Pseudobulbs:	1: absent
1: crowded	2: present
2: moderately spaced	9 – Stelidia, small tooth along upper margin:
3: widely spaced	1: absent
4 – Pseudobulbs, shape:	2: (tending to be) present
1: approx. cylindrical	10 – Stelidia, wings along lower margin:
2: ovoid or ellipsoid to lenticular	1: absent or inconspicuous
5 – Pseudobulbs, ribs:	2: deltoid, large
1: angular, tending to be irregularly warty	3: tooth-shaped, small
2: rounded, not warty	11 – Pollinia, number:
	1: two
	2: four

---

Table 2. Data-matrix for *Bulbophyllum* sect. *Adelopetalum*. The first six species (three from sect. *Sectochilus* and three from sect. *Macrouris*, respectively) are used as outgroups.

	1	2	3	4	5	6	7	8	9	10	11
<i>spec.</i>	1	1	3	2	2	1	2	1	2	1	2
<i>alticaule</i>	1	1	3	1	2	1	2	1	1	1	2
<i>foetidolens</i>	1	1	3	1	2	1	2	1	2	1	2
<i>desmotrichoides</i>	2	3	3	1	2	1	2	1	2	1	2
<i>dochotomum</i>	2	3	3	1	2	1	1	1	1	1	1
<i>imitator</i>	2	3	3	2	2	1	1	1	2	1	2
<i>argyropus</i>	1	2	1	2	1	2	1	1	1	1	1
<i>bracteatum</i>	1	2	1	2	1	1	1	1	2	1	1
<i>elizae</i>	1	2	1	2	1	1	2	1	2	1	2
<i>lageniforme</i>	1	2	1	2	2	2	2	1	2	2	2
<i>lilianae</i>	1	2	2	2	2	2	2	1	2	2	2
<i>lingulatum</i>	1	2	2	2	2	1	1	2	1	3	2
<i>newportii</i>	1	2	2	2	2	1	2	2	2	3	2

---

The analysis of the data-matrix of Table 2, with *B. spec.*–*B. alticaule*–*B. foetidolens* (sect. *Sestochilus*) as PIOS gives six most parsimonious cladograms (number of steps = 16, ci = 68, ri = 70). Among the six trees three topologies occur, with the branch *B. argyropus*–*B. bracteatum*–*B. elizae* as well as the branch *B. lingulatum*–*B. newportii*–*B. lilianae*–*B. lageniforme* in various positions. The latter group may be resolved either symmetrically or asymmetrically. After one time character-weighting one of these topologies remains; see Figure 8. *Bulbophyllum spec.* is chosen as the most immediate outgroup. In a second analysis, with only this species as outgroup, 4 cladograms are obtained at first, with a topology similar to those obtained with the first analysis, this time with the number of steps = 14, ci = 71 and ri = 69. After character-weighting the same cladogram as above remains.

The analysis with *B. desmotrichoides*–*B. dichotomum*–*B. imitator* (sect. *Macrouris*) as PIOS gives 15 most parsimonious cladograms after a first analysis (number of steps = 21, ci = 60, ri = 63). After one time character-weighting one of these cladograms remains, which has exactly the same topology as the final cladogram with *B. spec.*–*B. alticaule*–*B. foetidolens* as PIOS, depicted in Figure 8. *Bulbophyllum imitator* is chosen as the most immediate outgroup. An analysis with only this species gives again the same topology, with the number of steps = 16, ci = 68, ri = 64.

No PIOS came out as part of the ingroup during the analysis.

In most cladograms two main branches are present: *B. elizae*–*B. bracteatum*–*B. argyropus*, and *B. lageniforme*–*B. lilianae*–*B. newportii*–*B. lingulatum*. These branches are rather sturdy, the former only collapses incidentally during the analysis with *B. desmotrichoides*–*B. dichotomum*–*B. imitator* as PIOS, the latter in both series of analysis, but also rarely.

The choice of the cladogram in Figure 8, with *B. spec.* (Hoogland & Craven 10899) from sect. *Sestochilus* as the most immediate outgroup, as hypothesis for the phylogeny of sect. *Adelopetalum* is obvious. The PIOS *B. desmotrichoides*–*B. dichotomum*–*B. imitator* are rejected (and with them sect. *Macrouris* as paraphyletic tail to sect. *Adelopetalum*), because they produce less parsimonious cladograms. They also give more ambiguous results before character-weighting.

*Analysis of sect. Lepanthanthe* — The characters which have been used when analyzing sect. *Lepanthanthe* are given in Table 3.

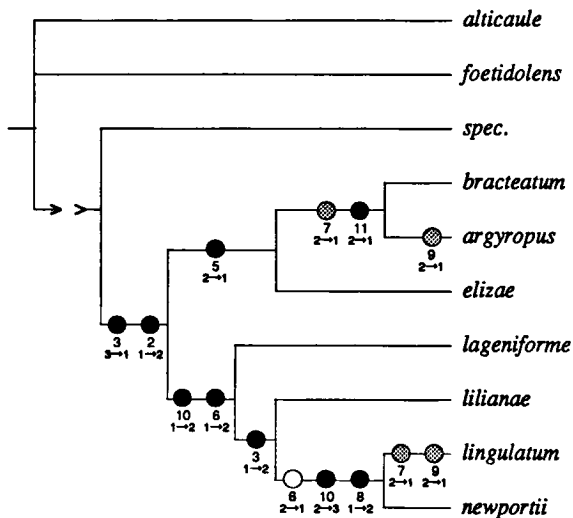

Fig. 8. The remaining most parsimonious cladogram of *Bulbophyllum* sect. *Adelopetalum*, with as outgroup the species *B. spec.*–*B. alticaule*–*B. foetidolens*, chosen out of a set of six cladograms after character-weighting one time. Apomorphies are given as black dots, parallel developments as grey dots, reversals as circles.

Table 3. The characters used for cladistic analysis of *Bulbophyllum* sect. *Lepanthanthe*.

- |   |  |
|---|--|
| <p>1 – Rhizome:<br/>             1: hanging<br/>             2: creeping</p> <p>2 – Pseudobulbs, size compared to the size of the plant:<br/>             1: minute<br/>             2: conspicuous</p> <p>3 – Leaf base:<br/>             1: narrowed<br/>             2: tending to cordate</p> <p>4 – Inflorescence:<br/>             1: many together on a short sympodium<br/>             2: single or few together</p> <p>5 – Peduncle and rachis, verrucae:<br/>             1: (tending to be) present<br/>             2: absent</p> <p>6 – Median sepal, tip:<br/>             1: a fleshy, subulate projection<br/>             2: obtuse to acuminate</p> <p>7 – Median sepal, margins:<br/>             1: glabrous or (partly) finely papillose or erose<br/>             2: ciliate</p> <p>8 – Median sepal, abaxial keel:<br/>             1: absent<br/>             2: present or tending to be present, if present crest erose</p> <p>9 – Lateral sepals:<br/>             1: free<br/>             2: (partly) connate along their lower margins</p> <p>10 – Lateral sepals, tip:<br/>             1: a fleshy, subulate projection<br/>             2: either a fleshy, subulate projection, or obtuse to apiculate<br/>             3: obtuse to acuminate</p> <p>11 – Petals, shape:<br/>             1: (orbicular to) elliptic or (ob)ovate, index 1–4<br/>             2: ovate-triangular, index 1.6–1.8<br/>             3: transversely elliptic to orbicular, index 0.6–1<br/>             4: narrowly triangular, index 10–15</p> <p>12 – Petals, margins:<br/>             1: glabrous to finely papillose or finely erose<br/>             2: coarsely denticulate<br/>             3: glabrous to coarsely denticulate<br/>             4: ciliate</p> | <p>13 – Petals, base:<br/>             1: sessile<br/>             2: with a very short claw<br/>             3: with a very short claw to distinctly clawed<br/>             4: distinctly clawed</p> <p>14 – Lip, lobes:<br/>             1: absent<br/>             2: inserted into the margins of the lip<br/>             3: inserted into adaxial surface of the lip</p> <p>15 – Lip, tip:<br/>             1: incurved<br/>             2: straight or recurved</p> <p>16 – Lip, presence of other papillae than those mentioned under 17:<br/>             1: no other large papillae present<br/>             2: approx. rod-shaped papillae tending to be present<br/>             3: orbicular to ovoid vesicles (tending to be) present<br/>             4: hairs (tending to be) present</p> <p>17 – Lip, adaxial side:<br/>             1: no keels<br/>             2: three keels</p> <p>18 – Lip, median slit on the adaxial side:<br/>             1: absent, because the ridges in between which the slit is usually situated, are absent<br/>             2: only at the base of the lip, abruptly closed in front<br/>             3: continuing up to half way the lip or further, open in front<br/>             4: continuing up to half way the lip or further, abruptly closed in front<br/>             5: continuing up to half way the lip or further, either open or abruptly closed in front<br/>             6: absent, because the ridges in between which the slit is always situated, all touch at one spot</p> <p>19 – Lip, tuft of papillae abaxially:<br/>             1: present<br/>             2: absent</p> <p>20 – Column, teeth along the lower margins:<br/>             1: absent<br/>             2: present or tending to be present</p> <p>21 – Column-foot:<br/>             1: without accessories or with inconspicuous, rounded lateral wings only<br/>             2: with distinct, acute lateral wings<br/>             3: with a small central tooth<br/>             4: with a very distinct central tooth</p> |
|---|--|

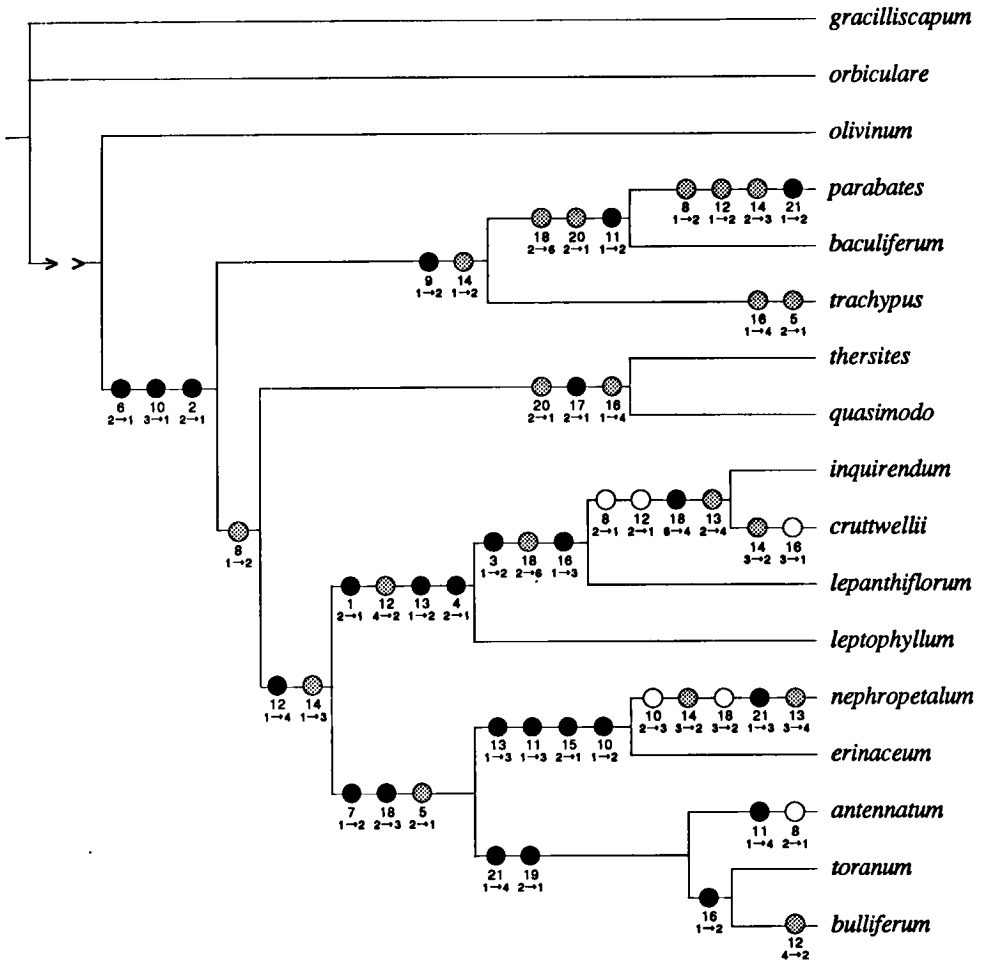

Fig. 9. The remaining most parsimonious cladogram of *Bulbophyllum* sect. *Lepanthe*, with as out-group the species *B. graciliscapum*–*B. olivinum*–*B. orbiculare*, after one time character-weighting. Apomorphies are given as black dots, parallel developments as grey dots, reversals as circles.

Table 4. Data-matrix for *Bulbophyllum* sect. *Lepanthe*. The first three species (from sect. *Macrouis*) are used as outgroups.

	1	2	3	4	5	6	7	8	9	10	11	12	13	14	15	16	17	18	19	20	21
<i>graciliscapum</i>	2	2	1	2	2	2	1	1	1	3	1	3	1	1	2	1	2	4	2	2	1
<i>olivinum</i>	2	2	1	2	2	2	1	1	1	3	1	1	1	1	2	1	2	2	2	2	1
<i>orbiculare</i>	2	2	1	2	1	2	1	1	1	3	1	3	1	1	2	4	2	5	2	2	1

(Table 4 continued)

	1	2	3	4	5	6	7	8	9	10	11	12	13	14	15	16	17	18	19	20	21
<i>cruttwellii</i>	1	1	2	1	2	1	1	1	1	1	1	1	4	2	2	1	2	4	2	2	1
<i>inquirendum</i>	1	1	2	1	2	1	1	1	1	1	1	1	4	3	2	3	2	4	2	2	1
<i>lepanthiflorum</i>	1	1	2	1	2	1	1	2	1	1	1	2	2	3	2	3	2	6	2	2	1
<i>leptophyllum</i>	1	1	1	1	2	1	1	2	1	1	1	2	2	3	2	1	2	2	2	2	1
<i>antennatum</i>	2	1	1	2	1	1	2	1	1	1	4	4	1	3	2	1	2	3	1	2	4
<i>erinaceum</i>	2	1	1	2	1	1	2	2	1	2	3	4	3	3	1	1	2	3	2	2	1
<i>nephropetalum</i>	2	1	1	2	1	1	2	2	1	3	3	4	4	2	1	1	2	2	2	2	3
<i>toranum</i>	2	1	1	2	1	1	2	2	1	1	1	4	1	3	2	2	2	3	1	2	4
<i>baculiferum</i>	2	1	1	2	2	1	1	1	2	1	2	1	1	2	2	1	2	6	2	1	1
<i>bulliferum</i>	2	1	1	2	1	1	2	2	1	1	1	2	1	3	2	2	2	3	1	2	4
<i>parabates</i>	2	1	1	2	2	1	1	2	2	1	2	2	1	3	2	3	2	6	2	1	2
<i>quasimodo</i>	2	1	1	2	2	1	1	2	1	1	1	1	1	1	2	4	1	1	2	1	1
<i>thersites</i>	2	1	1	2	2	1	1	2	1	1	1	1	1	1	2	4	1	1	2	1	1
<i>trachypus</i>	2	1	1	2	1	1	1	2	1	1	1	1	1	2	2	4	2	2	2	2	1

The analysis of the data-matrix of Table 4 yields two most parsimonious cladograms (number of steps = 58, ci = 63, ri = 72). These two have the same gross topology, differing only in a more symmetrical resolution of the group *B. inquirendum*-*B. cruttwellii*-*B. lepanthiflorum*-*B. leptophyllum* in one cladogram. After one time character-weighting the other cladogram is favoured, see Figure 9. During the analysis the PIOS never comes out among the ingroup. *Bulbophyllum olivinum* comes out as the immediate outgroup of the section. A second analysis with only *B. olivinum* as outgroup, produces a sequence of the same cladograms, this time with the number of steps = 53, ci = 66 and ri = 70.

This cladogram can be accepted as an hypothesis for the phylogeny of sect. *Lepanthanthe*.

*A first analysis of sect. Peltopus* — The characters which have been used when analyzing sect. *Peltopus* are given in Table 5.

Table 5. The characters used for cladistic analysis of *Bulbophyllum* sect. *Peltopus*.

- |   |  |
|---|--|
| <p>1 - Rhizome:</p> <p>1: hanging, rhizome scales longer than the nodes</p> <p>2: creeping</p> <p>3: hanging, rhizome scales shorter than the nodes</p> <p>2 - Pseudobulbs, distance between two adjacent:</p> <p>1: smaller than the length of the adjacent pseudobulb</p> <p>2: as large as the length of the adjacent pseudobulbs or larger</p> <p>3 - Pseudobulbs, size:</p> <p>1: generally 1 cm or larger</p> <p>2: generally smaller than 1 cm</p> | <p>4a - Inflorescence (not with <i>B. colliferum</i>, <i>B. leptoleucum</i> and <i>B. xanthochlamys</i> as outgroups)</p> <p>1: short, pedicel and ovary approx. covered with rhizome scales</p> <p>2: long, pedicel and ovary clearly visible</p> <p>4b - Inflorescence (only with <i>B. colliferum</i>, <i>B. leptoleucum</i> and <i>B. xanthochlamys</i> as outgroups)</p> <p>1: many-flowered</p> <p>2: 1-flowered</p> <p>5 - Median sepal, length:</p> <p>1: generally shorter than 6 mm</p> <p>2: generally longer than 6 mm</p> |
|---|--|

(Table 5 continued)

- 6 - Sepals, tip:  
1: acute to slightly acuminate  
2: long acuminate to caudate  
3: acute to caudate  
4: sharply acute
- 7 - Sepals, margins:  
1: glabrous  
2: partly or entirely papillose or ciliolate  
3: partly with distinct, long hairs
- 8 - Sepals, adaxial surface:  
1: glabrous  
2: tending to be pubescent
- 9 - Petals, size and shape:  
1: small  
2: 'normal' size  
3: 'normal' size, narrow
- 10 - Lip, length:  
1: generally shorter than 7 mm  
2: generally longer than 7 mm
- 11 - Lip, top part:  
1: broadly rounded to shortly acuminate  
2: tapering to a short or long acumen
- 12 - Lip, tip:  
1: warty adaxially  
2: not warty adaxially
- 13 - Lip, margins:  
1: glabrous  
2: papillose to ciliate, similar as on adaxial or abaxial surface  
3: with long hairs, similar as on abaxial surface  
4: ciliate, with the adaxial and abaxial surface glabrous  
5: with elongated, coarse papillae, as on adaxial surface  
6: with flattened, coarse papillae, as on adaxial surface
- 14 - Lip, basal concavity:  
1: approx. absent  
2: inconspicuous  
3: distinct
- 15 - Lip, basal teeth:  
1: an inconspicuous, transverse ridge  
2: a distinct transverse ridge  
3: a distinct, longitudinal, backwards pointing ridge
- 16 - Lip, notch between basal teeth:  
1: absent or very small  
2: present, with a slight to distinct swelling in front  
3: present, with a concave, triangular, disc-shaped structure in front  
4: present as an open slit, concave in front  
5: present as an open notch, concave in front  
6: present as an approx. closed slit, concave in front
- 17 - Lip, adaxially:  
1: basal part crested, top part flat or convex  
2: basal part convex, distinct, top approx. flat  
3: basal part concave, top concave because of the upturned margins  
4: approx. flat  
5: entirely concave, top margin recurved  
6: entirely concave, top margin incurved  
7: entirely concave, with a wart near the top  
8: basal part concave, top part flat or convex  
9: basal part slightly concave to convex, small, top part large, flat to distinctly convex
- 18 - Lip, large crest on adaxial surface:  
1: absent  
2: present
- 19 - Lip, three ridges adaxially in top part:  
1: absent  
2: present
- 20 - Lip, surface:  
1: approx. entirely glabrous  
2: adaxially glabrous, abaxially papillose or pilose  
3: adaxially papillose towards margins, abaxially glabrous  
4: (tending to) entirely finely papillose  
5: top part glabrous to coarsely papillose, papillae rounded  
6: top part glabrous to coarsely papillose, papillae elongated  
7: adaxially glabrous, abaxially with long hairs  
8: adaxially glabrous, abaxially papillose-hirsute  
9: adaxially transversely rugose, abaxially glabrous
- 21 - Stelidia:  
1: entirely absent  
2: (tending to be) present as two inconspicuous knobs or wings
- 22 - Stigma, lateral margins:  
1: distinctly flaring  
2: not or only slightly flaring
- 23 - Column-foot:  
1: straight or incurved  
2: slightly to distinctly recurved
- 24 - Knob on column-foot:  
1: small  
2: moderately large  
3: very large
- 25 - Knob on column-foot, tip:  
1: straight to somewhat incurved  
2: (tending to) moderately incurved  
3: (tending to) distinctly incurved  
4: distinctly inflexed



Table 6. Data-matrix for *Bulbophyllum* sect. *Peltopus*. The first three species (from sect. *Pelma*) are used as outgroups.

	1	2	3	4	5	6	7	8	9	10	11	12	13	14	15	16	17	18	19	20	21	22	23	24	25
<i>absconditum</i>	1	2	2	1	1	1	1	1	2	1	1	2	1	3	2	5	8	1	1	1	2	2	1	3	3
<i>pachytelos</i>	1	2	2	1	1	1	1	1	2	1	1	2	1	3	2	5	8	1	1	1	2	2	1	2	3
<i>simile</i>	1	2	2	1	1	1	1	1	2	1	1	2	6	3	2	5	8	1	1	5	2	2	1	2	3
<i>aechmophorum</i>	2	1	1	2	2	2	1	1	1	2	2	2	1	3	2	6	9	1	1	1	1	2	1	2	1
<i>alveatum</i>	2	1	1	2	2	2	1	1	1	2	1	1	1	3	2	5	8	1	1	1	1	2	1	3	2
<i>ankylochele</i>	2	1	1	2	2	2	2	1	1	2	1	2	2	3	2	5	2	1	1	4	1	1	1	3	3
<i>aphanopetalum</i>	2	1	2	2	2	1	1	1	1	1	2	1	3	2	5	8	1	1	1	1	1	2	1	3	2
<i>artostigma</i>	2	1	2	2	2	2	1	1	1	1	2	1	2	2	5	6	1	1	1	1	1	2	1	3	2
<i>bliteum</i>	2	2	1	2	2	1	2	1	1	1	1	2	1	2	2	5	8	1	1	1	1	2	1	2	2
<i>brachypetalum</i>	2	1	1	2	2	2	2	2	1	1	1	2	2	3	2	4	8	1	1	2	1	2	1	3	4
<i>brassii</i>	2	2	1	2	2	2	1	1	1	2	1	2	1	2	2	5	8	1	1	1	1	2	2	3	1
<i>calviventer</i>	1	1	1	2	2	2	2	1	1	1	1	2	2	3	2	5	8	1	1	2	1	2	1	3	4
<i>cycloglossum</i>	2	1	2	2	1	1	1	1	1	1	2	1	1	1	1	5	1	1	1	1	1	2	1	1	1
<i>discolor</i>	2	1	2	2	2	3	2	2	2	1	1	2	2	3	2	2	2	1	1	4	1	2	1	3	3
<i>cubitale</i>	2	1	2	2	1	1	2	2	2	1	1	2	2	3	2	2	2	1	1	4	1	2	1	3	3
<i>hiljeae</i>	2	1	1	2	2	2	1	1	1	2	1	2	1	3	2	6	9	2	1	1	1	2	1	3	1
<i>inciferum</i>	2	1	2	2	2	2	1	1	1	1	1	2	1	3	3	1	1	1	1	1	1	2	1	1	1
<i>intersinum</i>	2	1	2	2	2	2	2	1	2	1	1	2	2	3	2	2	2	1	1	4	1	2	1	3	3
<i>kenai</i>	2	1	2	2	2	2	1	1	1	1	1	2	3	1	1	1	4	1	1	7	1	2	1	2	1
<i>lophoton</i>	2	2	1	2	2	2	1	1	1	2	2	1	1	3	2	5	9	2	1	1	1	2	2	3	2
<i>loroglossum</i>	2	1	1	2	2	4	2	1	2	2	1	2	4	3	2	1	8	1	1	1	1	2	1	3	1
<i>minutipetalum</i>	2	1	1	2	2	2	2	2	1	1	1	2	2	3	2	2	8	1	1	4	1	1	1	3	3
<i>santoense</i>	2	1	1	2	2	2	2	1	1	1	1	2	2	3	2	2	2	1	1	4	1	1	1	3	3
<i>octarrhenipetalum</i>	2	1	1	2	2	3	2	2	1	1	1	2	1	3	2	2	2	1	1	1	1	2	1	3	3
<i>origami</i>	2	1	2	2	2	1	2	1	1	1	1	2	2	1	3	1	1	1	1	1	1	2	2	1	1
<i>ortalis</i>	2	1	2	2	2	2	2	1	1	1	1	2	5	1	3	1	1	1	1	6	1	2	2	1	3
<i>patella</i>	2	1	2	2	2	1	1	1	1	2	1	2	1	3	2	5	6	1	1	1	1	2	1	3	3
<i>peltopus</i>	2	1	1	2	2	2	1	1	3	2	1	2	1	3	2	6	8	1	1	1	1	2	1	3	1
<i>plicatum</i>	2	1	2	2	1	1	1	1	2	1	1	2	2	3	2	2	8	1	1	4	1	2	1	3	3
<i>ptychantyx</i>	2	1	1	2	2	2	2	1	1	2	1	2	2	3	2	4	3	1	2	2	1	2	1	3	3
<i>reevei</i>	2	1	1	2	2	2	2	1	1	2	2	2	2	3	2	6	9	1	1	8	1	2	1	3	3
<i>rhodoleucum</i>	2	1	1	2	2	2	2	1	1	2	1	2	2	2	2	5	8	1	1	1	1	2	2	3	1
<i>scutiferum</i>	2	1	2	2	2	1	1	1	1	1	1	2	1	1	1	4	1	1	1	1	1	2	1	1	1
<i>subapetalum</i>	3	2	1	2	2	2	2	1	1	1	2	2	1	3	2	3	8	1	2	1	1	2	2	3	1
<i>systemochilum</i>	2	2	1	2	2	2	1	1	1	2	2	2	1	3	2	6	9	1	1	1	1	2	1	3	2
<i>thelantyx</i>	1	1	1	2	2	1	2	1	1	1	1	2	2	3	2	5	5	1	1	3	1	2	1	3	1

The analysis with the data-matrix of Table 6, and with the PIOS *B. absconditum*–*B. simile*–*B. pachytelos* (sect. *Pelma*), gives over one hundred most parsimonious cladograms, with the number of steps = 120, ci = 45; ri = 63. In this case further processing to enable the selection of a cladogram as an hypothesis for the phylogeny of the section is

regarded as useless. Character-weighting is of no avail here: again more than one hundred most parsimonious cladograms are produced.

Small groups which stand out as separate branches in the majority of those one hundred are present. They have a more or less fixed overall composition of species, although their topologies may vary within the groups because of instability caused by the character distribution, as well as under influence of the varying most immediate outgroups.

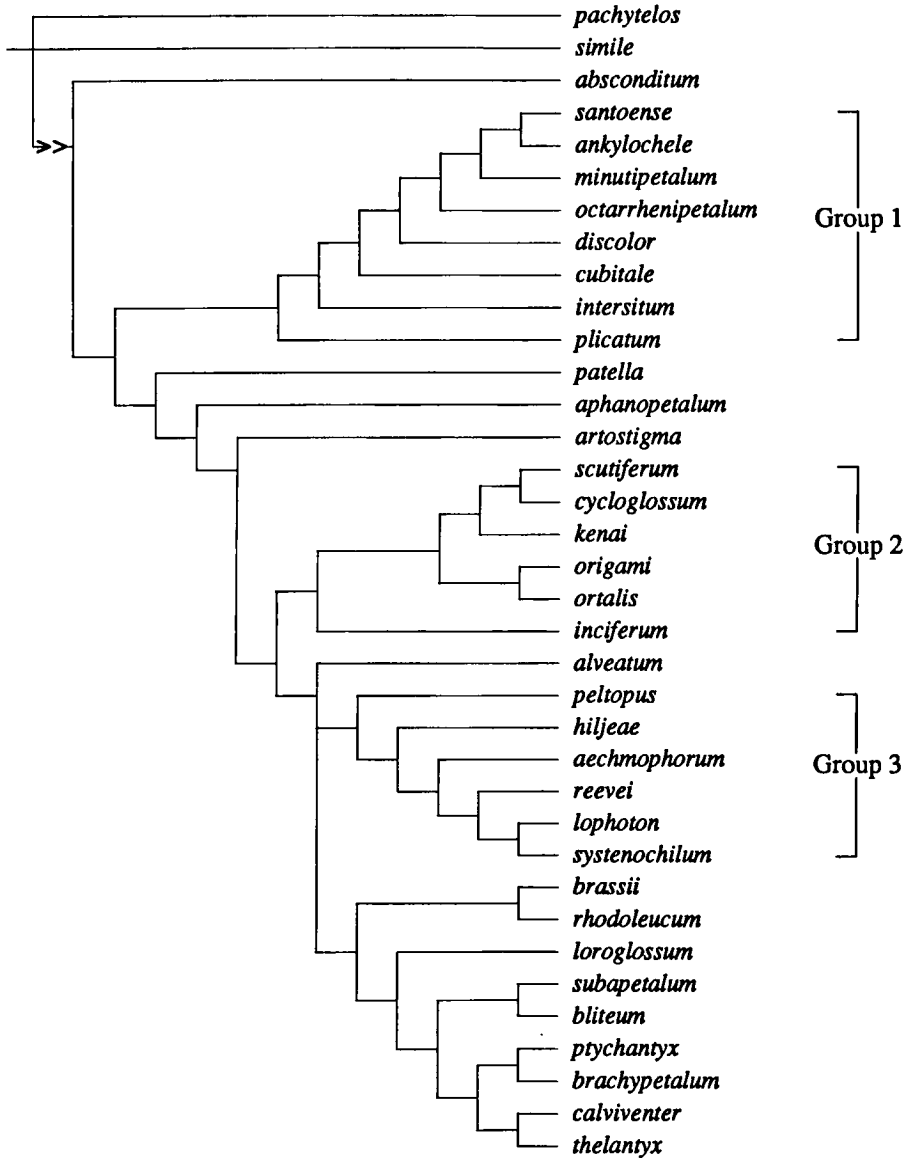

Fig. 10. An example of one of over 100 most parsimonious cladograms of *Bulbophyllum* sect. *Peltopus*, with as outgroup the species *B. pachytelos*–*B. simile*–*B. absconditum*, obtained at a first analysis of the whole data-matrix.

This way, the following branches can be recognized (see Figure 10 for an example of one of the cladograms obtained):

- 1) The group *B. plicatum* to *B. santoense* (8 species). This group stands out as a separate branch in most cases except for a few (14 out of 100) where *B. plicatum* is located elsewhere in the cladogram.

As immediate outgroup, *B. absconditum* occurs 76 times, although a branch containing other species than those of the ingroup sprouts from the cladogram immediately above this species (see Fig. 11).

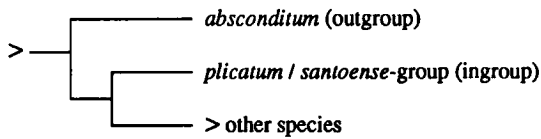

Fig. 11. For an explanation, see the text.

- 2) The group *B. inciferum* to *B. scutiferum* (6 species) constitutes a separate branch in 97 cladograms. In 3 cladograms *B. inciferum* is at the basis of the branch, in the same position as *B. absconditum* in Figure 11. *Bulbophyllum artostigma* occurs invariably as outgroup or as the species immediately below the ingroup.
- 3) The group *B. systemochilum* to *B. peltopus* (6 species). This stands out as a separate branch in all cladograms, although in a few occasions the lowermost species *B. peltopus* may be part of a trichotomy in which other species than those on the branch are involved. The species *B. alveatum* or the couple *B. rhodoleucum*–*B. brassii* occur in 99 cladograms as the species immediately below the lowermost ingroup species, *B. loroglossum* once.

All three groups mentioned above are acceptable for analysis, and the following sets of PIOS have been selected:

- for group 1: *B. absconditum*–*B. pachytelos*–*B. simile*;
- for group 2: *B. aphanopetalum*–*B. artostigma*–*B. patella*;
- for group 3: *B. alveatum*–*B. brassii*–*B. rhodoleucum*.

*Partial analysis of Bulbophyllum sect. Peltopus: group 1* — The characters which have been used for the analysis of group 1 are given in Table 7. The data-matrix used for the analysis of the groups is not simply extracted from the main data-matrix by deletion of the superfluous characters. Some characters used in the main data-matrix have been omitted because they can only be divided into clear-cut states in other parts of the cladogram, but less so in the species of group 1. A few other characters have been added.

Table 7. The characters used for cladistic analysis of *Bulbophyllum* sect. *Peltopus*, group 1.

- |  |   |
|--|---|
| <p>1 – Rhizome:<br/>             1: creeping<br/>             2: hanging</p> <p>2 – Pseudobulbs:<br/>             1: generally longer than 1 cm<br/>             2: generally shorter than 1 cm</p> <p>3 – Inflorescence:<br/>             1: short, pedicel and ovary approx. covered by rhizome scales<br/>             2: long, pedicel and ovary clearly visible</p> <p>4 – Median sepal, length:<br/>             1: generally shorter than 6 mm<br/>             2: generally longer than 6 mm</p> <p>5 – Sepals, tip:<br/>             1: acute to slightly acuminate<br/>             2: long acuminate to caudate<br/>             3: acute to caudate</p> <p>6 – Sepals, margins:<br/>             1: glabrous<br/>             2: partly or entirely papillose or ciliate</p> <p>7 – Sepals, adaxial surface:<br/>             1: glabrous<br/>             2: tending to be pubescent</p> <p>8 – Petals:<br/>             1: small<br/>             2: 'normal' size</p> | <p>9 – Lip, margins:<br/>             1: glabrous<br/>             2: papillose to ciliate</p> <p>10 – Lip, adaxially:<br/>             1: basal part concave, top part approx. flat<br/>             2: basal part convex, top part approx. flat or convex<br/>             3: basal part concave, top part concave because of upturned margins</p> <p>11 – Lip, adaxially:<br/>             1: basal part and top part tending to be separated by a distinct fold<br/>             2: basal part and top part not or hardly separated by a fold</p> <p>12 – Stelidia:<br/>             1: entirely absent<br/>             2: present as two inconspicuous knobs</p> <p>13 – Stigma, lateral margins:<br/>             1: distinctly flaring<br/>             2: not flaring</p> <p>14 – Knob on column-foot:<br/>             1: moderately large<br/>             2: very large</p> |
|--|---|

Table 8. Data-matrix for *Bulbophyllum* sect. *Peltopus*, group 1. The first three species (from sect. *Pelma*) are used as outgroup.

	1	2	3	4	5	6	7	8	9	10	11	12	13	14
<i>absconditum</i>	2	2	1	1	1	1	1	2	1	1	2	2	2	2
<i>pachytelos</i>	2	2	1	1	1	1	1	2	1	1	2	2	2	1
<i>simile</i>	2	2	1	1	1	1	1	2	3	1	2	2	2	1
<i>ankylochele</i>	1	1	2	2	2	2	1	1	2	2	2	1	1	2
<i>discolor</i>	1	2	2	2	3	2	2	2	2	2	1	1	2	2
<i>cubitale</i>	1	2	2	1	1	2	1	2	2	2	2	1	2	2
<i>intersitum</i>	1	2	2	2	2	2	1	2	2	2	2	1	2	2
<i>minutipetalum</i>	1	1	2	2	2	2	2	1	2	1	1	1	1	2
<i>santoense</i>	1	1	2	2	2	2	1	1	2	2	1	1	1	2
<i>octarrhenipetalum</i>	1	1	2	2	3	2	2	1	2	2	2	1	2	2
<i>plicatum</i>	1	2	2	1	1	1	1	2	2	1	1	1	2	2

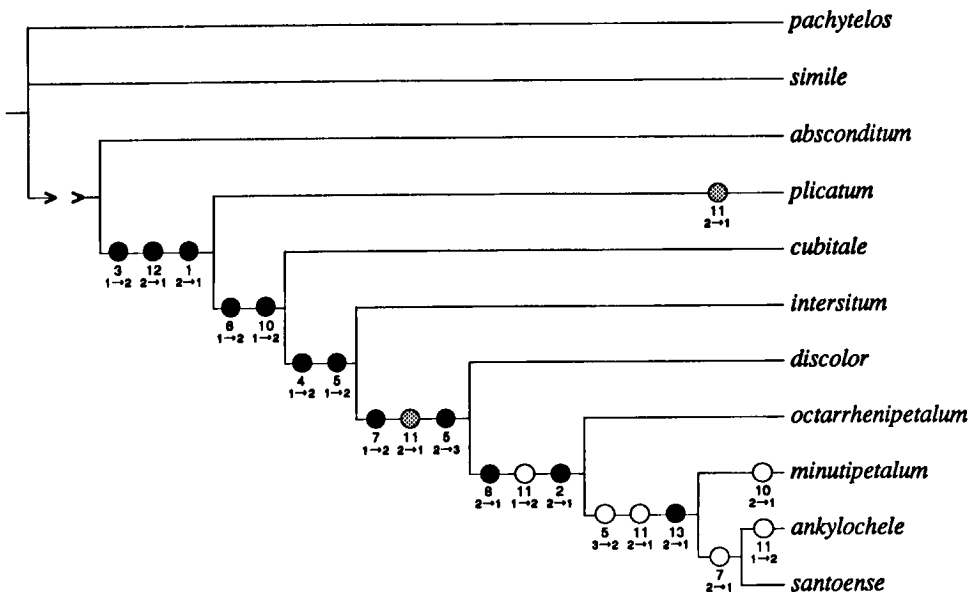

Fig. 12. The single most parsimonious cladogram of *Bulbophyllum* sect. *Peltopus*, group 1, with as outgroup the species *B. absconditum*–*B. pachytelos*–*B. simile*. Apomorphies are given as black dots, parallel developments as grey dots, reversals as circles.

The first analysis with the data-matrix of Table 8, and with *B. absconditum*–*B. pachytelos*–*B. simile* as PIOS yields eight most parsimonious cladograms (number of steps = 22,  $ci = 72$ ,  $ri = 83$ ). Among these, three different topologies are present: firstly the one depicted in Figure 12; a second with *B. discolor* and *B. octarrhenipetalum* to the very tip of the cladogram, beyond *B. santoense*, and a third with *B. discolor* and *B. octarrhenipetalum* as a separate branch. All other trees are due to the fact that the group *B. plicatum*–*B. discolor* subsp. *cubitale*–*B. intersitum* is resolved in various ways. *Bulbophyllum absconditum* comes out as the immediate outgroup. After one time character-weighting the cladogram of Figure 12 remains. The analysis with only *B. absconditum* as PIOS produces the same sequence of cladograms, this time with the number of steps = 20,  $ci = 70$  and  $ri = 71$ .

As an hypothesis for the phylogeny of the group the cladogram in Figure 12 is chosen, with *B. absconditum* as outgroup. This species resolves the ingroup most parsimoniously, as well as least ambiguously. This cladogram is not entirely in accordance with the taxonomy as presented in the revision of the section: *B. discolor* and *B. discolor* subsp. *cubitale* are not immediate neighbours; *B. intersitum* is placed in between. However, in the unweighted cladograms the three species tend to swap position; apparently this part of the cladogram is not too well supported. Although this cladogram is thought to best represent the true phylogeny of the group, *B. discolor* subsp. *cubitale* and *B. discolor* are maintained as subspecies of one single species in the revision, because in this case the rank ‘subspecies’ denotes technically imperfect resolution of two taxa, rather than a phylogenetic relationship, see also Chapter 4.

*Partial analysis of Bulbophyllum sect. Peltopus: group 2* — The characters which have been used for the analysis of group 2 are given in Table 9.

Table 9. The characters used for cladistic analysis of *Bulbophyllum sect. Peltopus*, group 2.

- |   |  |
|---|--|
| <p>1 – Sepals, tip:<br/>             1: acute to shortly acuminate<br/>             2: long acuminate to caudate</p> <p>2 – Sepals, margins:<br/>             1: glabrous<br/>             2: partly or entirely papillose or ciliate<br/>             3: partly with distinct, long hairs</p> <p>3 – Lip, top part:<br/>             1: sharply folded half-way<br/>             2: straight or gently recurved</p> <p>4 – Lip, tip:<br/>             1: broadly rounded<br/>             2: subacute to shortly acuminate</p> <p>5 – Lip, basal teeth:<br/>             1: absent<br/>             2: inconspicuous ridge without a notch<br/>             3: a distinct ridge with a notch<br/>             4: a more or less longitudinal crest</p> | <p>6 – Lip, basal concavity:<br/>             1: approx. absent<br/>             2: present, inconspicuous<br/>             3: present, distinct<br/>             4: present, not at all covered by the basal teeth</p> <p>7 – Column-foot:<br/>             1: straight or incurved<br/>             2: recurved</p> <p>8 – Column-foot, knob:<br/>             1: not or hardly incurved<br/>             2: moderately incurved<br/>             3: distinctly incurved</p> |
|---|--|

Table 10. Data-matrix for *Bulbophyllum sect. Peltopus*, group 2. The first three species are used as outgroups.

	1	2	3	4	5	6	7	8
<i>aphanopetalum</i>	1	1	2	2	3	3	1	2
<i>artostigma</i>	2	1	2	1	3	2	1	2
<i>patella</i>	1	1	2	1	3	3	1	3
<i>cycloglossum</i>	1	1	2	1	2	1	1	1
<i>inciferum</i>	2	1	2	2	4	3	1	1
<i>kenai</i>	2	1	2	2	1	1	1	1
<i>origami</i>	1	2	1	1	4	1	2	1
<i>ortalis</i>	2	2	1	1	4	1	2	3
<i>scutiferum</i>	1	1	2	1	2	2	1	1

The analysis of the data-matrix of Table 10, with *B. aphanopetalum*–*B. artostigma*–*B. patella* as PIOS gives a single most parsimonious cladogram (number of steps = 17, ci = 70, ri = 68); see Figure 13. *Bulbophyllum artostigma* comes out as the immediate outgroup. With only *B. artostigma* as PIOS, four most parsimonious cladograms are produced (number of steps = 14, ci = 85, ri = 87), one of which has the same topology as the one obtained with the previous set of PIOS. After one time character-weighting this cladogram is favoured.

The cladogram of Figure 13, with *B. artostigma* as most immediate outgroup species may be accepted as hypothesis for the phylogeny of group 2.

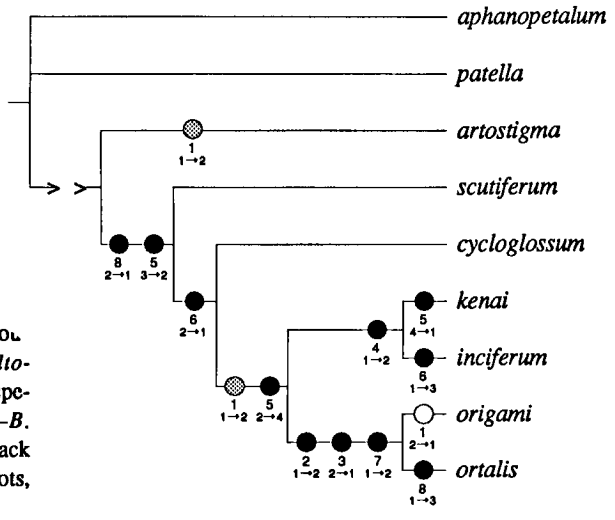

Fig. 13. The single most parsimonious cladogram of *Bulbophyllum* sect. *Peltopus*, group 2, with as outgroup the species *B. aphanopetalum*–*B. artostigma*–*B. patella*. Apomorphies are given as black dots, parallel developments as grey dots, reversals as circles.

*Partial analysis of Bulbophyllum sect. Peltopus: group 3* — The characters 2, 11, 12, 14, 16, 17, 18, 23, 25 from the initial data-matrix (Table 6) of sect. *Peltopus* have been used for the partial analysis. *Bulbophyllum alveatum*–*B. brassii*–*B. rhodoleucum* are used as PIOS. This gives two most parsimonious cladograms, with the number of steps = 16, ci = 62, and ri = 66 (see Fig. 14). They differ only because one of them has a trichotomy consisting of the group *B. aechmophorum*, *B. reevei*, and the couple *B. lophoton* and *B. systemochilum*. The most immediate outgroup is *B. alveatum*. With only *B. alveatum* as outgroup five cladograms are produced, with the number of steps = 13, ci = 69, and ri = 55. Two of these have the same topology as the two obtained with the first analysis; the others differ only in being rooted at the other end, between *B. lophoton* and *B. systemochilum*. Otherwise the five only differ in having variously located trichotomies. All cladograms obtained can be regarded as having essentially the same topology. This topology is accepted as an hypothesis for the phylogeny, with *B. alveatum* as outgroup (see Fig. 14).

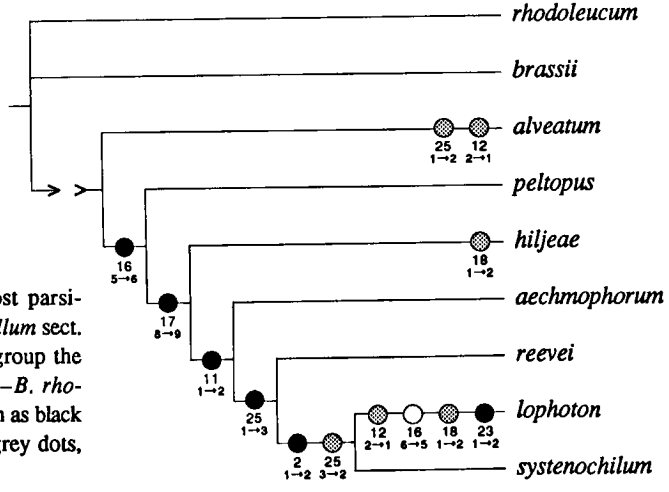

Fig. 14. The best resolved most parsimonious cladogram of *Bulbophyllum* sect. *Peltopus*, group 3, with as outgroup the species *B. alveatum*–*B. brassii*–*B. rhodoleucum*. Apomorphies are given as black dots, parallel developments as grey dots, reversals as circles.

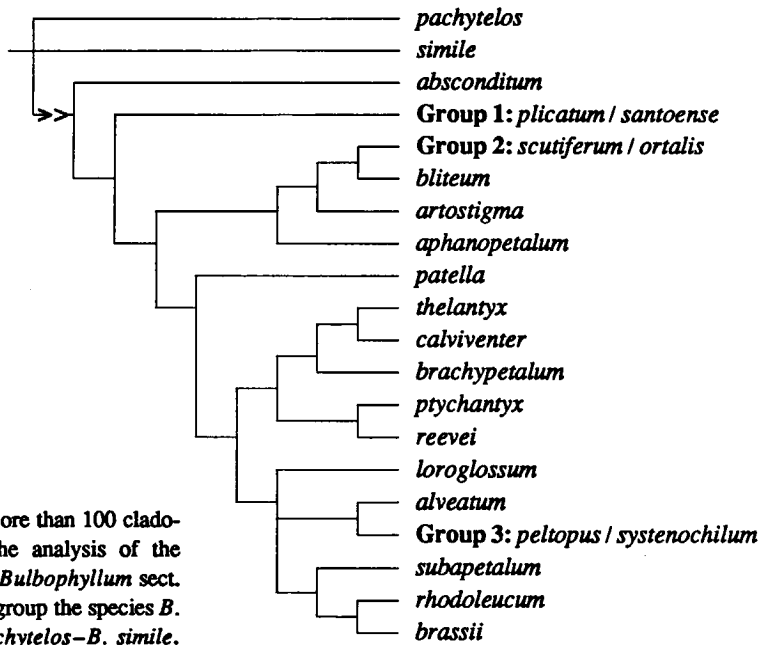

Fig. 15. One of the more than 100 cladograms found with the analysis of the 'paraphyletic tail' of *Bulbophyllum* sect. *Peltopus*, with as outgroup the species *B. absconditum*—*B. pachytelos*—*B. simile*.

*A second analysis of sect. Peltopus* — Now the number of species to be included in the analysis of sect. *Peltopus* can be reduced by replacing the groups 1, 2, 3 by their basal species. Since we now have distinctly fewer species, fewer characters are needed. A number of characters showing a similar state within all species of the remaining group have of course been omitted, as well as those which are not very relevant for the remaining group of species. For the analysis the characters 1, 2, 4, 5, 6, 7, 9, 10, 11, 14, 16, 17, 19, 20, 21, 23, 24, 25 of the original data-matrix (Table 6) have been used.

The analysis with *B. absconditum*—*B. pachytelos*—*B. simile* as PIOS gives over 100 different most parsimonious cladograms with the number of steps = 61, ci = 59, ri = 64. An example is given in Figure 15. Character-weighting is not very helpful; the number of most parsimonious cladograms remains larger than 100.

To find a value for the ci and ri for the ingroup with a single outgroup, a second analysis has been executed with *B. absconditum* (the most immediate outgroup species) only. This also produced more than 100 most parsimonious cladograms (number of steps = 57, ci = 61, ri = 65), many with a different topology than those found in the first analysis.

All results together are such that no cladogram can be accepted as an hypothesis for the phylogeny of the basal group of sect. *Peltopus*. A few conclusions, however, can be drawn:

- 1) *B. absconditum* always comes out as most immediate outgroup species.
- 2) *B. plicatum* always comes out as lowermost ingroup species. These two conclusions corroborate the results of the analysis of sect. *Peltopus*, group 1.
- 3) *B. scutiferum*, the lowermost ingroup species of sect. *Peltopus*, group 2, comes out close to (but generally with *B. bliteum* in between) *B. artostigma*, which confirms the selection of the latter species as most immediate outgroup during the analysis of group 2.



4) *B. peltopus*, the lowermost ingroup species of sect. *Peltopus*, group 3, comes out close to *B. alveatum* in 77 out of 100 cladograms, which corroborates the selection of the latter species as most immediate outgroup during the analysis of group 3.

Notwithstanding the rather promising a priori prospects, the quest for an acceptable cladogram for the paraphyletic 'tail' of sect. *Peltopus* has been a failure. During the first analysis of the group, many terminal branches are found in which species have a fixed position. The basal nodes, however, give rise to much swapping. As said above, this can be explained by the large number of character reversals within the section, but only partly so. Even when stripped of a number of terminal branches, so that the number of reversals per analysis is reduced, no unambiguous results are obtained. The reasons for this failure may be twofold:

- 1) Many species of the section show autapomorphies, rather than apomorphies shared by a number of species. This has made the coding of the characters very difficult, producing a shortage of characters which has haunted the analysis.
- 2) Many characters are found in the structure of the lip and the column. Interdependence of characters is very difficult to establish here. If two characters are dependent (if they, in fact, together constitute a single character) but coded as separate characters, they will carry an undue weight during analysis and thus make branches which are not phylogenetically significant.

Finally, the *ci* and the *ri* of the cladogram of sect. *Peltopus*, as composed from the accepted cladograms of group 1, 2 and 3, as well as the depicted cladogram of the paraphyletic 'tail', has been calculated: number of steps = 192, *ci* = 28, *ri* = 61. Apparently the compound cladogram is not among the most parsimonious ones.

*Analysis of Bulbophyllum sect. Uncifera* — The characters which have been used when analyzing sect. *Uncifera* are given in Table 11.

---

Table 11. The characters used for cladistic analysis of *Bulbophyllum* sect. *Uncifera*.

<p>1 – Rhizome:</p> <p>1: erect, patent or pendulous</p> <p>2: creeping</p> <p>2 – Inflorescence:</p> <p>1: always 1-flowered</p> <p>2: 1–2-flowered</p> <p>3: (1–)2-many-flowered</p> <p>3 – Lip:</p> <p>1: recurved</p> <p>2: approx. straight</p> <p>4 – Lip:</p> <p>1: little concave at the base, distinctly convex at the tip</p> <p>2: distinctly concave at the base, flat to convex at the tip</p>	<p>5 – Lip, knobs at the base:</p> <p>1: absent</p> <p>2: inconspicuous</p> <p>3: inconspicuous to distinct</p> <p>4: distinct</p> <p>6 – Stelidia, lower margins:</p> <p>1: a distinct tooth present, close to the tip</p> <p>2: tooth absent</p> <p>7 – Pollinia:</p> <p>1: two</p> <p>2: two, sometimes four</p> <p>3: four, sometimes two</p> <p>4: four</p>
---	--

---

Table 12. Data-matrix for *Bulbophyllum* sect. *Uncifera*. The first six species (three from sect. *Sestochilus* and three from sect. *Macrouris*, respectively) are used as outgroups.

	1	2	3	4	5	6	7
<i>spec.</i>	2	3	1	2	1	2	4
<i>alticaule</i>	2	3	1	2	3	2	4
<i>foetidolens</i>	2	3	1	2	1	2	4
<i>desmotrichoides</i>	1	3	2	2	1	2	4
<i>dichotomum</i>	1	2	2	2	1	2	1
<i>imitator</i>	1	3	1	2	1	2	4
<i>cylindrobulbum</i>	2	3	1	2	3	1	3
<i>exiguum</i>	2	3	1	2	2	1	1
<i>laxum</i>	2	1	1	2	2	1	3
<i>manobulbum</i>	2	2	1	2	2	1	1
<i>bigibbum</i>	1	1	1	1	4	1	4
<i>cavibulbum</i>	1	2	1	2	2	1	4
<i>ochroleucum</i>	1	3	1	2	3	1	2
<i>posticum</i>	1	1	1	1	4	1	4

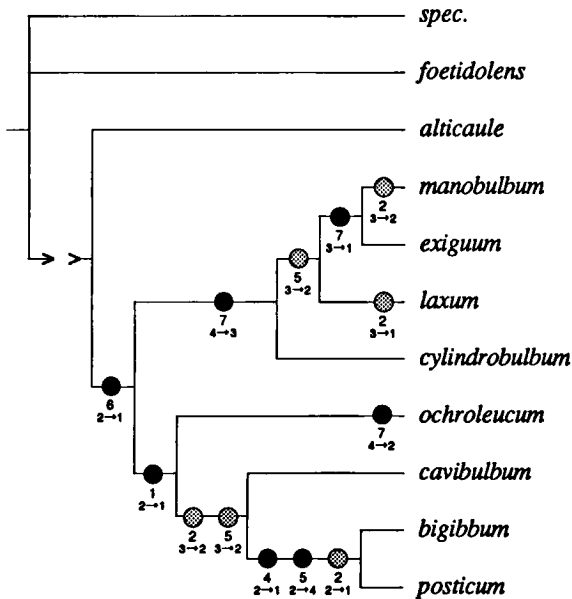

Fig. 16. One of the two remaining most parsimonious cladograms of *Bulbophyllum* sect. *Uncifera*, with as outgroup the species *B. spec.*–*B. alticaule*–*B. foetidolens*, chosen out of a set of eight cladograms after character-weighting one time. Apomorphies are given as black dots, parallel developments as grey dots, reversals as circles.

The analysis of the data-matrix of Table 12, with *B. spec.*–*B. alticaule*–*B. foetidolens* (from sect. *Sestochilus*) as the set of PIOS gives eight most parsimonious cladograms (number of steps = 14, ci = 78, ri = 80). After one-time character-weighting 2 cladograms remain. These two have essentially the same topology; one differs in having the group *B. posticum*–*B. bigibbum*–*B. cavibulbum*–*B. ochroleucum* not entirely resolved. Both cladograms are present among the original eight. One of these two cladograms (the entirely resolved one) is given in Figure 16. *Bulbophyllum alticaule* comes out as the most immediate outgroup species. A second analysis with only *B. alticaule* as outgroup gives a sequence of cladograms which have the same topology, the number of steps = 13, ci = 76, ri = 75.

The analysis with *B. desmotrichoides*–*B. dichotomum*–*B. imitator* (from sect. *Macrouris*) as set of PIOS yields 77 most parsimonious cladograms (number of steps = 17, ci = 70, ri = 72). After two times character-weighting the number of trees stabilizes on no less than 71. Invariably *B. imitator* is chosen as the most immediate outgroup here. The two main branches of the final cladogram obtained with the previous set of PIOS are present in many of these. Compared with this cladogram *B. imitator*, with the character state 'rhizome hanging', mainly causes a re-rooting of the cladogram of the ingroup without fundamentally changing it. A second analysis with only *B. imitator* as outgroup gives 73 cladograms (number of steps = 14, ci = 78, ri = 72) of approximately the same topology. After two times character-weighting 69 of these remain.

Although the two cladograms found with *B. spec.*–*B. alticaule*–*B. foetidolens* as the set of PIOS look intuitively quite convincing, both main branches may collapse in some cladograms. In the original eight cladograms the branches are in some cases woven into each other, and in other cases single species may easily swap branches. The 77 cladograms obtained with the other set of PIOS show even more variation. During all analyses no PIOS came out among the ingroup species.

*Bulbophyllum alticaule* resolves the ingroup most parsimoniously, and least ambiguously. Therefore, sect. *Sestochilus* can be accepted as the paraphyletic surroundings of sect. *Uncifera*. *Bulbophyllum alticaule* is the most immediate outgroup, and the cladogram depicted in Figure 16 is accepted as an hypothesis for the phylogeny of sect. *Uncifera*.

With this choice the striking similarity between *B. imitator* (sect. *Macrouris*, seemingly the most obvious immediate outgroup species of sect. *Uncifera*) and *B. ochroleucum* (sect. *Uncifera*) is ignored. An explanation for this similarity may be the following:

- 1) *B. imitator* belongs to sect. *Uncifera*, but is not recognized as such because of the loss of the unique character of that section, the semi-elliptic tooth along the lower margin of the stielidia.
- 2) *B. imitator* belongs to sect. *Macrouris* but shows convergence towards sect. *Uncifera*.
- 3) *B. imitator* is a species that developed out of a hybrid between a species of sect. *Uncifera* (e.g. *B. ochroleucum*) and a species of another section, probably from sect. *Macrouris*, perhaps from series C.

The first possibility may be rejected for several reasons. If a cladistic analysis is performed with *B. spec.*–*B. alticaule*–*B. foetidolens* as outgroups and with *B. imitator* added to the ingroup, the latter species is firmly consigned towards the base, among the outgroups, in all obtained cladograms. Besides, *B. imitator* has two keels on the adaxial side of the lip, a character absent in sect. *Uncifera*, but occurring in sect. *Macrouris*.

The second possibility, an almost perfect convergence in floral as well as vegetative parts (and including the red colour the specimens attain when dried, which is common in sect. *Uncifera*, but not in sect. *Macrouris*), is possible but less likely.

The least unlikely possibility is that *B. imitator* has gained its sect. *Uncifera*-like appearance because it originated as a hybrid between e.g. *B. ochroleucum* of sect. *Uncifera* and a species of sect. *Macrouris* series C.

*Analysis of the paraphyletic sections* — We have now arrived at the sections which are earmarked a priori as ‘paraphyletic tails’. In accordance with the procedure outlined above, the lowermost ingroup species of the monophyletic sections derived from the paraphyletic tails will be included in the analysis.

*Analysis of Bulbophyllum sect. Pelma* — The characters used for the analysis of sect. *Pelma* are given in Table 13. To represent sect. *Peltopus*, of which sect. *Pelma* is a paraphyletic tail, *B. plicatum* has been added to the data-matrix. Two sets of PIOS are tried: the trio *B. desmotrichoides*–*B. dichotomum*–*B. imitator* as well as *B. pidacanthum*–*B. scopae*–*B. sessile*. The last species belongs to sect. *Oxysepalum*, which is not revised here.

Table 13. The characters used for cladistic analysis of *Bulbophyllum* sect. *Pelma*.

- |   |  |
|---|--|
| <p>1 – Rhizome scales:<br/>           1: Shorter or slightly longer than the internodes<br/>           2: distinctly longer than the internodes</p> <p>2 – Inflorescence:<br/>           1: always 1-flowered<br/>           2: 1–3-flowered, inflorescence elongated<br/>           3: 1–2-flowered, inflorescence short<br/>           4: 2–many-flowered</p> <p>3 – Sepals:<br/>           1: with 1 vein<br/>           2: with 3 veins<br/>           3: with more than 3 veins</p> <p>4 – Petals, shape:<br/>           1: (ob)ovate to elliptic or spatulate<br/>           2: (tending to) rhombiform</p> <p>5 – Petals:<br/>           1: with 1 vein<br/>           2: with 3 veins</p> <p>6 – Lip:<br/>           1: curved<br/>           2: not or hardly curved</p> <p>7 – Lip, basal concavity:<br/>           1: absent<br/>           2: present</p> <p>8 – Lip, basal part adaxially:<br/>           1: an orbicular to approx. rectangular, distinct cavity immediately in front of the basal teeth<br/>           2: a much elongated, distinct cavity<br/>           3: moderately concave</p> | <p>(8) 4: with a small, approx. triangular slight concavity<br/>           5: convex</p> <p>9 – Lip, two ridges adaxially between basal and top part:<br/>           1: absent because top part absent<br/>           2: absent, basal part gradually passing into top part<br/>           3: present, converging towards the tip, with a furrow in between<br/>           4: present, approx. parallel, with a furrow in between<br/>           5: present, converging, ending in a median tooth<br/>           6: present, parallel, with a third in between</p> <p>10 – Lip, top part adaxially:<br/>           1: flat or convex<br/>           2: convex, very large<br/>           3: more or less absent</p> <p>11 – Lip, top part adaxially:<br/>           1: glabrous<br/>           2: tending to finely papillose<br/>           3: tending to coarsely papillose</p> <p>12 – Column-foot, lump near ligament:<br/>           1: absent<br/>           2: present, distinctly incurved<br/>           3: present, not or hardly incurved</p> <p>13 – Stigma, base:<br/>           1: not thickened, without a tooth<br/>           2: thickened, without a tooth<br/>           3: thickened, with a tooth</p> |
|---|--|

(Table 13 continued)

- 14 – Stelidia:  
 1: absent  
 2: approx. absent, two narrow seams along stigma as well as clinandrium  
 3: tending to be present, short, triangular, rounded  
 4: present, tending to acute
- 15 – Rostellum:  
 1: not or only slightly protruding  
 2: distinctly protruding
- 16 – Pollinia, number:  
 1: two  
 2: four
- 17 – Pollinia, shape:  
 1: rounded  
 2: pointed at one end
- 18 – Stipes:  
 1: absent or very inconspicuous  
 2: present, distinct

Table 14. Data-matrix for *Bulbophyllum* sect. *Pelma*. The first six species (from sect. *Macrouris*) are used as outgroups.

	1	2	3	4	5	6	7	8	9	10	11	12	13	14	15	16	17	18
<i>desmotrichoides</i>	1	4	3	1	2	2	1	3	3	1	1	1	1	4	1	2	1	1
<i>dichotomum</i>	1	3	2	1	1	2	1	3	3	1	1	1	1	4	1	1	1	1
<i>imitator</i>	1	4	2	1	1	1	1	3	3	1	1	1	1	4	1	2	1	1
<i>pidacanthum</i>	2	4	2	1	1	1	1	3	2	1	2	1	1	4	1	1	1	1
<i>scopa</i>	2	4	2	1	1	1	1	3	3	1	1	1	3	4	1	1	1	1
<i>sessile</i>	1	1	2	1	1	1	1	3	2	1	1	1	1	4	1	1	1	1
<i>absconditum</i>	2	1	2	2	1	2	2	1	1	3	1	2	1	1	2	2	2	2
<i>ankylorhinum</i>	2	4	3	1	2	1	1	3	2	1	3	1	3	4	2	2	1	2
<i>bacilliferum</i>	2	4	1	1	1	1	2	2	2	1	1	2	1	2	2	2	1	2
<i>colliferum</i>	2	4	3	1	1	1	1	3	2	1	3	1	1	4	1	2	1	2
<i>fractiflexum</i>	2	4	2	1	1	1	2	3	2	1	1	2	2	3	2	2	1	2
<i>gyaloglossum</i>	2	4	2	1	1	2	2	1	1	3	1	2	1	1	2	2	2	2
<i>latipes</i>	2	2	2	1	1	1	2	3	6	1	1	2	1	2	2	2	1	2
<i>leptoleucum</i>	2	4	2	1	1	1	2	4	2	2	1	3	1	3	1	2	1	2
<i>leucothyrus</i>	2	4	3	1	2	1	1	3	2	1	2	1	1	4	1	2	1	2
<i>macilentum</i>	2	4	1	1	1	1	2	4	2	2	1	2	1	3	1	2	1	2
<i>melanoxanthum</i>	2	4	2	1	1	1	2	2	2	1	1	2	1	2	2	2	1	2
<i>mesodon</i>	2	4	2	1	1	1	2	3	5	1	2	2	1	4	1	2	1	2
<i>mischobulbum</i>	2	4	2	1	1	1	2	3	4	1	2	2	1	4	1	2	1	2
<i>ochthochilum</i>	2	1	2	1	1	1	1	3	2	1	1	3	2	1	2	2	1	2
<i>oliganthum</i>	2	2	2	1	1	1	2	3	2	1	1	2	1	3	2	2	1	2
<i>pachytelos</i>	2	1	2	1	1	1	2	3	2	1	1	2	1	4	2	2	1	2
<i>savaiense</i>	2	4	1	1	1	2	2	1	1	3	1	2	1	1	2	2	2	2
<i>simile</i>	2	1	1	1	1	2	2	3	2	1	3	2	1	4	1	2	1	2
<i>stipulaceum</i>	2	1	1	2	1	2	2	1	1	3	1	2	1	1	2	2	2	2
<i>tanystiche</i>	2	4	2	1	1	1	2	3	4	1	2	2	1	4	1	2	1	2
<i>xanthochlamys</i>	2	4	2	1	1	1	2	3	5	1	2	2	1	4	1	2	1	2
<i>plicatum</i>	2	1	2	1	1	1	2	5	2	1	2	2	1	1	2	2	1	2

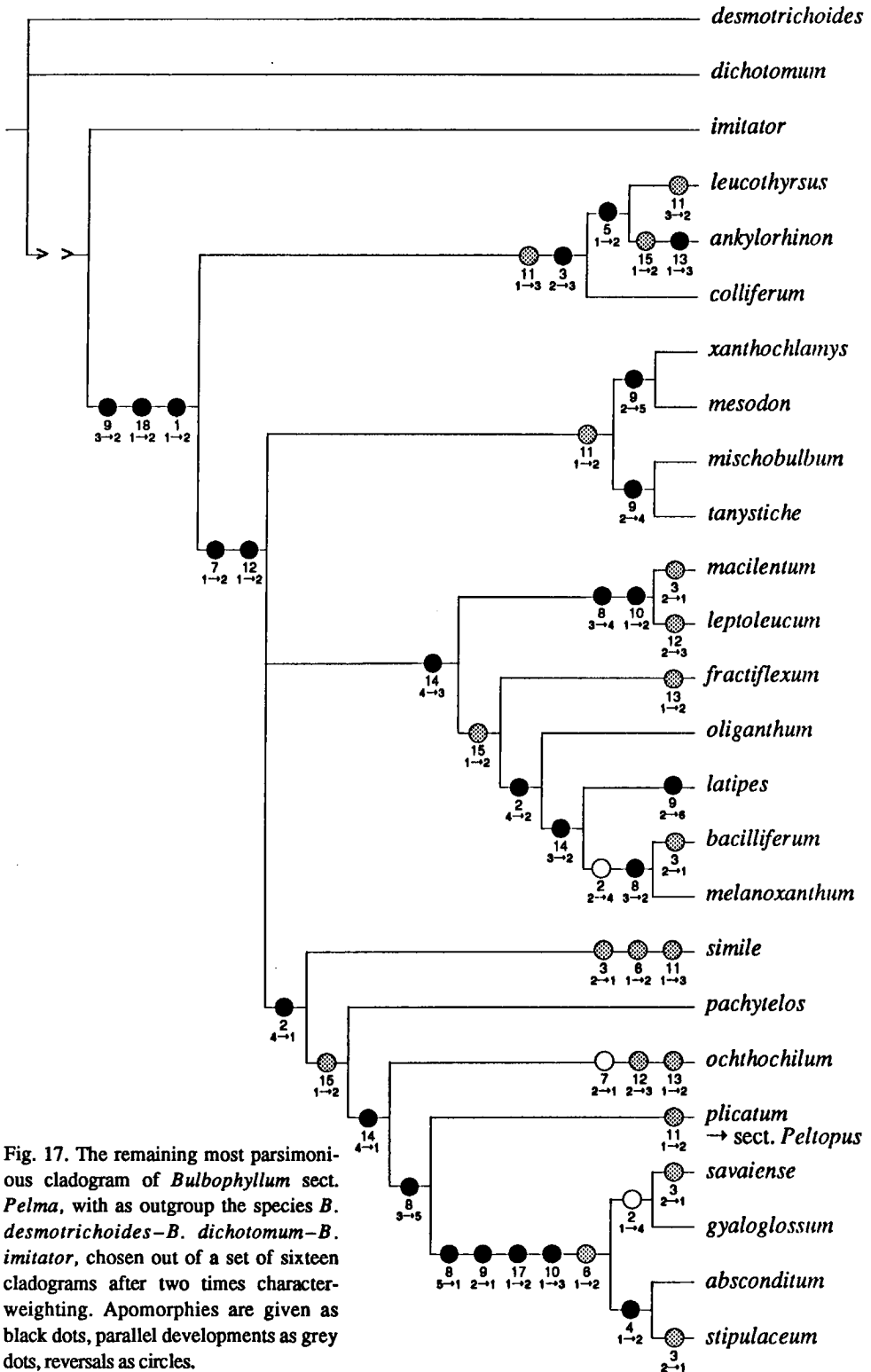

Fig. 17. The remaining most parsimonious cladogram of *Bulbophyllum* sect. *Pelma*, with as outgroup the species *B. desmotrichoides*–*B. dichotomum*–*B. imitator*, chosen out of a set of sixteen cladograms after two times character-weighting. Apomorphies are given as black dots, parallel developments as grey dots, reversals as circles.

The first analysis of the data-matrix of Table 14, with *B. desmotrichoides*–*B. dichotomum*–*B. imitator* (from sect. *Macrouris*) as set of PIOS gives 16 most parsimonious cladograms (number of steps = 52, ci = 65, ri = 79). These cladograms have more or less the same topology, differing only because various groups such as *B. xanthochlamys* to *B. tanystiche*, *B. fractiflexum* to *B. latipes*, and *B. ochthochilum*–*B. plicatum*—the foursome around *B. gyaloglossum* may collapse into trichotomies. One trichotomy in the lower nodes is present in all. One time character-weighting is sufficient to favour one cladogram out of these sixteen, one in which all trichotomies except the last are resolved, see Figure 17. *Bulbophyllum imitator* is the favoured candidate as immediate outgroup. With only this species as PIOS the same sequence of results is obtained, this time with the number of steps = 47, ci = 68, ri = 78.

The analysis with *B. pidacanthum*–*B. scopa*–*B. sessile* (the first two from sect. *Macrouris*, the last from sect. *Oxysepalum*) as set of PIOS yields 58 most parsimonious cladograms (number of steps = 51, ci = 64, ri = 77). These all show the same gross topology as the 16 obtained during the previous analysis. After two times character-weighting the number of cladograms stabilizes on 10. The species *B. pidacanthum* is chosen as the most immediate outgroup here; if this species is applied alone, 48 cladograms come out with the number of steps = 47, ci = 67, ri = 78, again with the same gross topology as above. After character-weighting 8 of these remain.

The different sets of PIOS hardly influence the resolution of the ingroup, and they all more or less equally resolve it parsimoniously. It is therefore assumed that both must be rather close to the ingroup. Because the outgroups *B. desmotrichoides*–*B. dichotomum*–*B. imitator* distinctly less ambiguously resolve the ingroup, the cladogram depicted in Figure 17 is chosen as hypothesis for the phylogeny of sect. *Pelma*. The preference of *B. imitator* as the most immediate outgroup is somewhat unfortunate in view of its possible hybrid origin (see above).

The fact that the species-pair *B. plicatum*–*B. absconditum* comes out in the same branch (be it not as immediate neighbours) of the accepted cladogram of sect. *Pelma*, confirms the selection of *B. absconditum* as most immediate outgroup species for sect. *Peltopus*; see the analysis of the latter section.

The PIOS never came out within the ingroup during analysis. Even *B. sessile* (sect. *Oxysepalum*) which is, except for its 1-flowered inflorescences, rather similar to species of sect. *Pelma* such as *B. colliferum*, is always firmly lodged at the base. Apparently sect. *Oxysepalum* is not rooted in sect. *Pelma*. *Bulbophyllum sessile* will again be included in the analysis of sect. *Macrouris*.

*Analysis of Bulbophyllum sect. Macrouris* — To 'make the section monophyletic' a number of species have been added to the data-matrix. *Bulbophyllum trachypus* and *B. colliferum*, both present in basal position in the cladograms of the sections *Lepanthanthe* and *Pelma* respectively, are included to represent these sections. Also added are selected species of two sections which have not been revised, and assumedly have as most immediate outgroup a species of sect. *Macrouris*: *B. sessile* representing sect. *Oxysepalum*, *B. microsphaerium* representing sect. *Nematorhizis*, *B. alticaule* representing sect. *Sestochilus*. The analysis of sect. *Uncifera* has revealed that it is likely that the outgroup of that section is to be found in sect. *Sestochilus* rather than in sect. *Macrouris*. No species representing this section has therefore been added to the data-matrix.

*Bulbophyllum mulderae* (sect. *Macrouris*) has been left out, because it is only marginally different from *B. cateurum*.

The characters which have been used for the analysis of sect. *Macrouris* are given in Table 15.

Table 15. The characters used for cladistic analysis of *Bulbophyllum* sect. *Macrouris*.

- |   |  |
|---|--|
| <p>1 – Rhizome:</p> <ol style="list-style-type: none"> <li>1: creeping</li> <li>2: creeping, with the ends patent</li> <li>3: patent or <math>\pm</math> pendulous, pseudobulbs shorter than the rhizome portions</li> <li>4: pendulous, perpendicularly hanging downwards</li> </ol> <p>2 – Pseudobulbs:</p> <ol style="list-style-type: none"> <li>1: distinct</li> <li>2: inconspicuous compared to the size of the plant</li> </ol> <p>3 – Rhizome internodes:</p> <ol style="list-style-type: none"> <li>1: those half-way between two pseudobulbs distinctly elongated</li> <li>2: all of approx. equal length, or some slightly elongated only</li> </ol> <p>4 – Rhizome nodes, position and number:</p> <ol style="list-style-type: none"> <li>1: more than 6, at regular intervals</li> <li>2: approx. 6, at regular intervals</li> <li>3: approx. 6, one half-way between two pseudobulbs, the others close to the pseudobulbs</li> <li>4: approx. 3, none half way, all close to the pseudobulbs</li> </ol> <p>5 – Rhizome scales:</p> <ol style="list-style-type: none"> <li>1: all much longer than the internodes</li> <li>2: all somewhat longer or somewhat shorter than the internodes</li> <li>3: those covering the longest internode distinctly shorter than that internode, the others as in 2</li> </ol> <p>6 – Rhizome, wings:</p> <ol style="list-style-type: none"> <li>1: absent</li> <li>2: (tending to be) present</li> </ol> <p>7 – Leaf, shape:</p> <ol style="list-style-type: none"> <li>1: generally wide, base abruptly narrowed or even cordate</li> <li>2: generally narrow, base generally decurrent</li> </ol> <p>8 – Leaf, tip:</p> <ol style="list-style-type: none"> <li>1: rounded to acute</li> <li>2: narrowly acute to acuminate</li> </ol> <p>9 – Inflorescence, number of flowers:</p> <ol style="list-style-type: none"> <li>1: one or two, sometimes three</li> <li>2: generally two or more, rachis not very thin and not zigzag bent</li> <li>3: two or more, rachis tending to very thin and zigzag bent</li> </ol> | <p>10 – Inflorescence:</p> <ol style="list-style-type: none"> <li>1: glabrous</li> <li>2: tending to be verrucate</li> </ol> <p>11 – Sepals, tip:</p> <ol style="list-style-type: none"> <li>1: acute to shortly acuminate, or with a subulate projection</li> <li>2: (tending to) long acuminate to caudate</li> </ol> <p>12 – Median sepal, index:</p> <ol style="list-style-type: none"> <li>1: generally less than 1.8</li> <li>2: generally more than 2</li> </ol> <p>13 – Median sepal, folds near base:</p> <ol style="list-style-type: none"> <li>1: present</li> <li>2: absent</li> </ol> <p>14 – Lip, shape:</p> <ol style="list-style-type: none"> <li>1: divided in a wide basal part and a narrow top part</li> <li>2: not divided in a wide basal part and a narrow top part, or only slightly so</li> </ol> <p>15 – Lip:</p> <ol style="list-style-type: none"> <li>1: solid, thick</li> <li>2: soft</li> <li>3: solid, thin</li> </ol> <p>16 – Lip, keels on adaxial surface:</p> <ol style="list-style-type: none"> <li>1: no keels, or generally very inconspicuous keels only</li> <li>2: two, generally distinct keels, converging towards the tip and leaving no furrow in between</li> <li>3: two, generally distinct keels, converging towards the tip but leaving a</li> <li>4: three keels [furrow in between]</li> </ol> <p>17 – Stelidia:</p> <ol style="list-style-type: none"> <li>1: distinct</li> <li>2: inconspicuous</li> </ol> <p>18 – Stelidia, tooth along lower margin:</p> <ol style="list-style-type: none"> <li>1: absent</li> <li>2: (tending to be) present, deltoid to subulate</li> <li>3: present, fused to the stelidia as a truncate wing</li> </ol> <p>19 – Foot stigma:</p> <ol style="list-style-type: none"> <li>1: not swollen</li> <li>2: swollen, but approx. without teeth</li> <li>3: swollen, with a distinctly protruding</li> <li>4: swollen, with 3 teeth [tooth]</li> </ol> <p>20 – Pollinia:</p> <ol style="list-style-type: none"> <li>1: two</li> <li>2: four</li> </ol> |
|---|--|



Table 16. Data-matrix for *Bulbophyllum* sect. *Macrouris*. The first three species (from the sections *Macrouris*, *Lepanthanthe* and *Pelma*, respectively) have been added to the data-matrix to obtain a monophyletic group; the second group of three species (from the sections *Nematorhizis*, *Oxysepalum* and *Sestochilus*, respectively) may be representatives of monophyletic groups, but they may also be the outgroup species.

	1	2	3	4	5	6	7	8	9	10	11	12	13	14	15	16	17	18	19	20
<i>imitator</i>	3	1	2	?	2	1	2	1	2	1	1	2	2	2	1	3	2	1	1	2
<i>trachypus</i>	1	2	2	2	2	1	2	1	3	2	1	1	2	2	1	4	2	2	2	1
<i>colliferum</i>	3	1	2	2	1	1	2	1	2	1	1	?	2	2	1	1	2	1	1	2
<i>microsphaerium</i>	1	1	2	2	2	1	2	1	1	1	1	?	2	2	2	1	2	1	3	1
<i>sessile</i>	3	1	2	1	2	1	2	1	1	1	2	2	2	2	1	1	2	1	1	1
<i>alticaule</i>	1	1	2	1	2	1	2	1	2	1	1	1	2	2	1	2	2	1	1	2
<i>grammopoma</i>	1	1	2	2	2	1	2	1	2	1	1	1	2	2	1	4	1	1	3	1
<i>sceliphron</i>	1	1	2	2	2	1	2	1	2	1	1	1	2	2	1	4	1	1	3	1
<i>callichroma</i>	1	1	2	1	2	1	2	2	2	1	1	2	1	2	1	2	2	3	3	2
<i>cardiophyllum</i>	4	2	?	?	1	2	1	2	2	1	2	2	2	2	2	1	2	1	2	1
<i>cateorum</i>	4	2	1	4	3	2	1	2	1	1	2	2	2	2	2	1	2	1	2	1
<i>chloranthum</i>	1	1	2	1	2	1	2	2	2	1	1	2	1	2	1	4	2	3	3	2
<i>dekokkii</i>	2	1	2	?	3	1	2	2	2	1	2	2	2	2	2	1	2	1	2	1
<i>dendrochiloides</i>	2	1	1	3	3	1	2	1	2	1	2	2	2	1	3	1	2	1	2	1
<i>fonsflorum</i>	1	1	2	2	2	1	2	2	2	1	2	2	2	2	1	1	2	1	2	1
<i>graciliscapum</i>	1	1	?	?	2	1	2	1	3	1	1	1	2	2	1	4	2	2	2	1
<i>kaniense</i>	2	1	1	3	3	1	2	2	2	1	2	2	2	2	2	1	2	1	2	1
<i>levatii</i>	1	1	2	1	2	1	2	1	2	1	2	2	2	2	1	2	2	2	2	1
<i>macrourum</i>	4	2	1	3	3	2	1	2	2	1	2	2	2	2	2	1	2	1	2	1
<i>musciola</i>	1	1	2	2	2	1	2	1	2	1	1	?	2	2	2	1	2	1	3	1
<i>myon</i>	4	1	1	3	3	2	2	2	2	1	1	2	2	2	2	2	2	1	2	1
<i>olivinum</i>	1	1	2	1	2	1	2	1	2	1	1	1	2	2	1	4	2	2	4	1
<i>orbiculare</i>	1	1	2	2	2	1	2	1	3	2	1	1	2	2	1	4	2	2	2	1
<i>oreodoxa</i>	1	1	2	2	2	1	2	2	2	1	2	2	2	2	2	1	2	1	2	1
<i>phormion</i>	2	1	?	3	3	1	2	1	2	1	2	2	2	1	2	1	2	1	2	1
<i>pidacanthum</i>	3	1	2	2	1	1	2	1	2	1	2	2	2	1	1	1	2	2	2	1
<i>scopa</i>	3	1	2	2	1	1	2	1	2	1	1	2	2	2	2	2	2	1	3	1
<i>trifilum</i>	3	1	1	3	3	1	2	2	2	1	2	2	2	2	2	1	2	2	2	1
<i>desmotrichoides</i>	3	1	1	3	3	1	2	1	2	1	1	2	2	2	1	3	2	1	1	2
<i>dichotomum</i>	3	1	2	1	2	1	2	2	1	1	2	2	2	2	1	3	2	1	1	1
<i>glaucum</i>	4	2	1	4	3	2	1	2	1	1	2	2	2	2	2	1	2	1	1	1

One analysis of the data-matrix in Table 16 is performed, with *B. alticaule* arbitrarily chosen as outgroup. The analysis gives four most parsimonious cladograms (number of steps = 65, ci = 49 ri = 77) with the same topology. They differ only in some parts being collapsed into trichotomies, viz. the species groups *B. macrourum* to *B. glaucum*, and *B. kaniense* to *B. trifilum*. Character-weighting to reduce the number of cladograms is of no

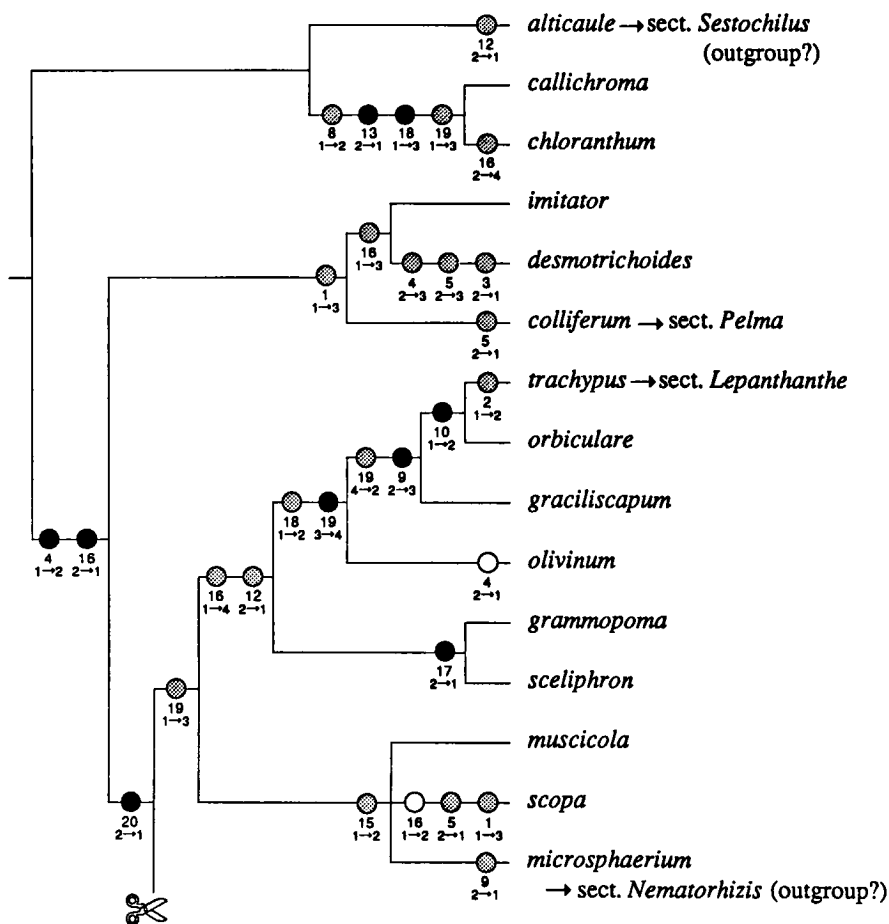

(continued on next page)

Fig. 18. The best resolved, most parsimonious cladogram of *Bulbophyllum* sect. *Macrouris*, out of four with the same topology. The species *B. alticaule* has functioned as outgroup, but the cladogram has been left unrooted. Apomorphies are given as black dots, parallel developments as grey dots, reversals as circles.

avail here; it rather increases the number of trees. Therefore the best resolved cladogram is chosen, except for the a priori chosen outgroup species. The cladogram is left unrooted for reasons given in the paragraphs on the a priori assumptions for the analysis of sect. *Macrouris*. See Figure 18.

The assumed paraphyletic nature of sect. *Macrouris* is not contradicted by this analysis. All monophyletic terminal branches, as well as all possible outgroup species come out widely dispersed throughout the cladogram.

The fact that the species-pair *B. trachypus*–*B. olivinum* comes out in the same branch (be it not as immediate neighbours) of the accepted cladogram of sect. *Macrouris*, confirms the selection of *B. olivinum* as most immediate outgroup species for sect. *Lepanthanthe* after the analysis of the latter section.

(Fig. 18 continued)

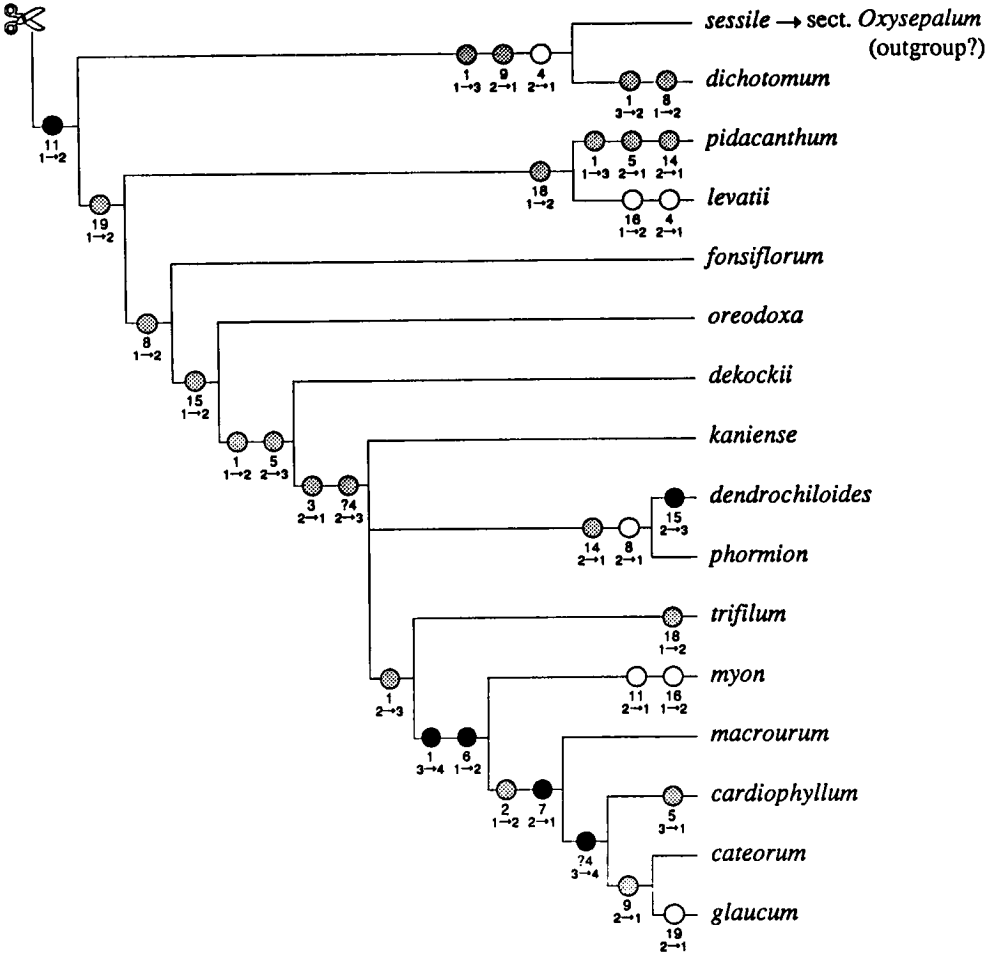

The position of the couple *B. colliferum*–*B. imitator* in the accepted cladogram of sect. *Macrouris* similarly confirms the choice of the latter species as most immediate outgroup species of sect. *Pelma*.

### 7.6. The phylogenetic relationship between the sections

With the data obtained above, the a priori scheme of Figure 7 can be updated now to a final scheme indicating the relationships between the various sections; see Figure 19. Because the phyletic status of the sections *Sestochilus*, *Oxysepalum* and *Nematorhizis* is unknown, the scheme has to be left unrooted. Each of these three sections may connect this scheme to the rest of *Bulbophyllum*. It is clear now that all sections revised in this volume

together presumably do not represent a monophyletic group; sect. *Uncifera* as well as sect. *Adelopetalum* are rooted in sect. *Sestochilus*, whereas the other sections are rooted in sect. *Macrouris*.

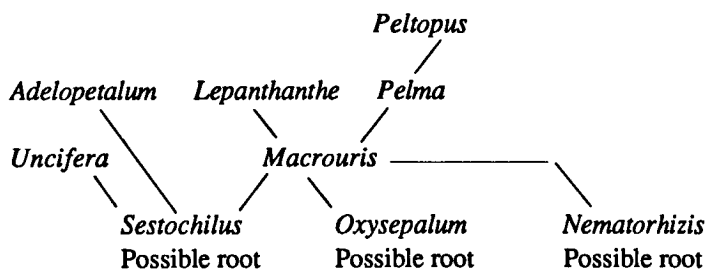

Fig. 19. Unrooted scheme indicating the phylogenetic relationships between the sections. This scheme is an update from Figure 7.

### 7.7. Discussion

The cladistic analysis that has been undertaken leads to a few generalizations reaching beyond the analyzed groups.

*Afterthoughts on the wish to distinguish monophyletic groups* — A classification of a group which reflects its assumed phylogeny is preferable in phylogenetic taxonomy, because such a classification is maximally informative (Wiley, 1981: 239). It is realized most easily with selected, comparatively small groups of species. With speciose groups, application of this basic principle may lead to supra-specific groups which are characterized by only the poorest polythetic set. This is mainly because, with an increase of the number of species in a group, the number of character reversals in the cladogram which serves as an hypothesis for the phylogeny of the group increases as well.

*Bulbophyllum* is a large genus, and the problem outlined above was severely felt during the revisions. If the "sequencing convention" (Nelson, 1972, 1974; coining of the term by Wiley, 1981: 206) is applied rigorously to the sections of *Bulbophyllum* revised in this volume, this leads in some cases to undesirable results: the monophyletic section *Lepanthanthe* should also contain *B. orbiculare* to *B. olivinum* in order not to create a paraphyletic tail consisting of these species. This would mean that the monothetic set for that section "pseudobulbs minute, inconspicuous; tip of sepals a fleshy, subulate projection" would become a rather slim polythetic set. *Bulbophyllum grammopoma* and *B. sceliphron* could be made a separate section characterized by one character "stelidia long, subulate." The two could also be included in sect. *Lepanthanthe*, adding a polythetic character to that section: "lip with a median ridge." This character, however, is difficult to observe in some species and, moreover, occurs in *B. chloranthum*, a species which definitely has to be placed outside the section.

Provided that sect. *Nematorhizis* does not contain the outgroup of sect. *Macrouris*, the alternative circumscription of sect. *Lepanthanthe* would also lead to the inclusion of *B. muscicola* and *B. scopia* in sect. *Nematorhizis*. This would deprive this section of part of its none too sturdy monothetic set (compared to its immediate phylogenetic surroundings) "rhizome creeping, inflorescence 1-flowered." It would also make necessary the inclusion of *B. dichotomum*, with its 2-flowered inflorescences, in sect. *Oxysepalum*, which is partly characterized by the character "inflorescence 1-flowered." Finally, it would lead to the recognition of *B. pidacanthum* to *B. glaucum* as a monophyletic section, with no other circumscription than a most meagre set of characters which one by one occur outside the group. This section then would have to be keyed out against the basal species of all the above mentioned sections.

For users of the revisions, being not familiar with the taxonomy of *Bulbophyllum*, these alternative sections would be difficult to recognize in many cases. Species with a large overall similarity would be included in different sections.

It has therefore been thought convenient not to apply the 'sequencing convention', and to accept the fact that the phylogeny is only partly reflected in the classification. In this revision, demarcations between sections are such that they are *all* (not one at the cost of another) optimally recognizable. This still leads to considerable problems, for example, in a key to the sections which needs eleven couplets to key out six sections.

Some sections will have a set of characters such that monophyly can be assumed; other sections will have a set of characters which merely consist of synplesiomorphies, and the sections will probably be paraphyletic groups. In fact, the recognition of optimally recognizable groups has been common practice for a long time already for those working on large groups (Sleumer, 1966, 1967, in his revision of the Malesian Ericaceae). Its explicit recognition goes back as far as Bentham (1861: 151), who recognized genera of convenience.

Little harm can be found in such procedures, as long as an assessment of the phylogenetic status is given with the revision of each section, preferably together with a phylogenetic analysis of the group. It does not imply that the phylogenetic analysis as such is rejected. To show the nature of the groups recognized, and as an explanation of the patterns of distribution of characters found during a revision, the cladistic analysis is a necessary part of a revision. The 'predictive' value of this classification is not less than that of a classification which follows the phylogeny; new species may fit as easily in groups characterized by synplesiomorphies as they do in groups characterized by synapomorphies. Optimally recognizable groups will not necessarily destabilize nomenclature; once they are circumscribed only large sets of new characters might overthrow them.

*Monophyly of the genus Bulbophyllum and the advisability of splitting the genus into smaller genera* — Several supposedly monophyletic sections of *Bulbophyllum* have been raised to generic level in recent years. These sections are characterized by sets of characters of a size and strength at most equalling that of the sets for the monophyletic sections revised in this volume. Presumably they also represent terminal branches in the phylogenetic tree of *Bulbophyllum*. Examples are *Hapalochilus* and *Epicriantes* (both Garay & Kittredge, 1985). Other groups of similar nature around *Bulbophyllum* are retained as genera by recent authors, following a tradition, while agreeing that they are closely related to *Bulbophyllum*. Examples are *Trias* (Seidenfaden, 1976), *Drymoda* and *Monomeria* (both Seidenfaden, 1986).

Under the requirements of the 'phylogenetic school' a genus can only be split up if no groups remain that are characterized only by the absence of characters occurring in the other groups, i.e. if the genus can be split up entirely into monophyletic groups. Paraphyletic groups, as often created when severing off terminal branches of a cladogram, are regarded as uninformative and therefore unwanted. It seems appropriate to cite Dressler (1981: 148) here: "There are cases, of course, when classification is a matter of opinion. When there are two distinct but closely allied groups of species, they may be treated as subgenera of a single genus or as two closely allied genera, and neither arrangement does violence to the pattern of relationship." The phylogenetic school rejects this. 'Closely allied' means that the phylogenetic relation between the groups may be either that the two groups may both be monophyletic (sister-groups), or that one is the paraphyletic tail of the other group. If the relation is of the first kind, lumping does little justice to the phylogeny; if it is of the second kind, splitting is equally unjustified; see Figure 20. The analyses performed above show that the relation of the sections revised in this volume to the genus *Bulbophyllum* as a whole is of the second kind.



Fig. 20. Phylogenetic trees of the closely related groups A and B. Left: both groups are monophyletic; recognition of two genera is warranted here. Right: A is the paraphyletic 'tail' of B; recognition of B as a genus leaves A as a second, not-natural genus. A and B are better kept as one genus here.

Taxonomists only wishing to achieve groups with a large overall similarity (such as the 'phenetic school'), will not readily raise the sections of *Bulbophyllum* to generic level, because a morphologically heterogeneous group is left over.

Only the adherent of the 'classical school' may find some justification for such splitting. He regards monophyletic groups and paraphyletic grades as entities of equal value. By not acknowledging the rather fundamental difference between the two, he sees no objections against taking a smaller monophyletic unit out of a larger one, and implicitly leaving the latter as a paraphyletic group (which is not a 'natural' group).

However, the sets of characters which have been used to raise the sections *Hapalochilus* and *Epicriantes* to generic level are by no means as unique and clear-cut within *Bulbophyllum* as their authors believe them to be. In both cases, series of intermediate species exist which link these sections to other sections. The delimitation of the group depends heavily on the set of characters attributed to it: dropping a character will lead to a considerably larger group. All quibbling afterwards over species of uncertain position will inevitably lead to the transfer of species from one genus to the other, with ensuing name changes. If the groups are kept as sections, species swapping has no consequences for the nomenclature. Besides, extraction of only one or two sections is an act of arbitrariness. It should be embedded in an equal treatment of the genus as a whole. With the standards applied in this revision this would lead to the splitting of *Bulbophyllum* into approximately 100 different genera. The taxonomy of the group would not become easier to comprehend by non-specialists. The *Bulbophyllinae* as a whole (sensu Dressler, 1981: 231) is a fairly readily

recognizable group, in the field as well as in the herbarium. Very few species are of doubtful position. In the light of the stability of nomenclature, it is highly desirable to keep such a group as one genus.

*Ambiguity as a selecting criterion* — In two out of three analyses (sect. *Pelma* excepted) in which more than one set of PIOS has been applied, the outgroup which most parsimoniously resolves the ingroup happens to be the one which least ambiguously resolves it as well; see the summarized results in Table 17.

Table 17. Results of all analyses in which more than one set of PIOS has been applied.

The species names are abbreviated with their first three characters, the section names with the first four. Further abbreviations: nc = number of cladograms; ci = consistency index; ri = retention index; ns = number of steps; nw = number of times character-weighting is necessary, either to reduce the number of cladograms to 1, or to stabilize the number of cladograms. Accepted cladograms indicated with an <.

	First analysis with three outgroups							Second analysis with one outgroup							
	outgroups	nc	ci	ri	ns	nw	nc	og	nc	ci	ri	ns	nw	nc	
ADEL: sp.-alt-foe	6	68	70	16	1	1		sp.	4	71	69	14	1	1	<
des-dic-imi	15	61	66	21	1	1		imi	11	68	64	16	1	1	
PELM: des-dic-imi	16	65	79	52	1	1		imi	16	68	78	47	1	1	<
pid-sco-ses	58	64	77	51	1	10		pid	48	67	78	47	1	8	
UNCI: sp.-alt-foe	8	78	80	14	1	2		alt	8	76	75	13	1	2	<
des-dic-imi	77	70	72	17	2	71		imi	73	78	72	14	2	69	

Probably a connection does indeed exist between parsimony and ambiguity in the sense as used above.

## 8. A BIOGEOGRAPHICAL ANALYSIS OF THE REVISED SECTIONS

### 8.1. Introduction

Numerous authors (see for overviews Audley Charles, 1987; George, 1987) have already elaborated upon the floristic and faunistic differences between the Eastern and the Western part of Malesia (sensu Van Steenis, 1950: LXXII; 1979: 102). Two biogeographic realms are generally recognized. The demarcation between them is somewhat dependent of the plant or animal group studied, and has been variously located by different authors (see Van Steenis, 1950: LXXIII; George, 1987). The genus *Bulbophyllum* occurs in both realms in comparable numbers of species (c. 450 in East Malesia, and c. 350 in West Malesia). However, few of these occur in both realms. Examples in this volume are: *B. absconditum*

and *B. savaiense* subsp. *subcubicum* (both sect. *Pelma*). Other species are *B. unguiculatum* Reichb. f. (sect. *Aphanobulbon*), *B. macranthum* Lindl. (sect. *Sestochilus*) and possibly one species of the section *Fruticicola* as well as two more of the section *Polyblepharon*.

West Malesia is inhabited by a number of relatively widespread *Bulbophyllum* species. Next to these, a number of areas can be located with numerous endemics.

Sulawesi, which is more or less on the borderline between East and West, is remarkable for the often very odd endemics among its *Bulbophyllum* species. Otherwise, elements from both the East as well as the West occur.

In East Malesia most *Bulbophyllum* species are endemic to New Guinea. In all surrounding archipelagos (such as the Moluccas, New Britain, New Ireland, the Solomons, etc.) comparatively few species occur. Some of these are the same as in New Guinea, others are endemic, though generally showing a distinct similarity with New Guinean species.

Australia has about 25 species only. Most of these are endemic.

Close phylogenetic relations undoubtedly exist between the species of both realms. This is partly demonstrated by the fact that the demarcation between East and West is rather obscure when considering *Bulbophyllum* at section level. Most sections, as outlined by Schlechter (1911–1914) and J.J. Smith (1911–1935; 1914), occur in both realms. However, a closer inspection shows that they are either richly represented in West Malesia and have only few species in East Malesia, or vice versa. Only a few sections do not follow that rule; sect. *Sestochilus*, for instance, is well represented in both realms.

In this chapter an attempt has been made to divide New Guinea into smaller areas of endemism, to find relationships between such areas, as well as to provide explanations for these distribution patterns.

## 8.2. Recognition of areas of endemism in New Guinea

If the distributions of all the revised species are plotted on a single map, it appears that most show overlapping ranges. A quest for cladogram branches which carry three or more species with mutually exclusive ranges, such as is necessary for a historical biogeographical analysis, is not very fruitful. However, it is obvious that: 1) numerous species are restricted to the central mountain range of New Guinea; 2) numerous species occupy only a part of this range; 3) in certain regions many range boundaries coincide.

To be able to compare ranges, it is convenient to describe them here all in the same terms: small areas called 'range units'. The range of each species can be described as a sum of range units. The observation that locally numerous range boundaries coincide is very helpful: such spots evidently mark relevant boundaries between range units. This leads in New Guinea to the recognition of three East–West-running zones: the central mountain range, roughly bordered to the North (from East to West) by the Markham, Ramu, Sepik, Taritatu and Tariku Rivers respectively, and to the South by the 100 m contour line. North of this zone is the northern mountain range, South of it the southern lowlands. These East–West zones can be further divided into range units according to coinciding North–South-running range boundaries of species. All islands West of New Guinea are included in a single range unit, because hardly any endemics occur there. The islands Northeast and East of New Guinea and Australia have been divided into several range units. All range units are given in Map 1.



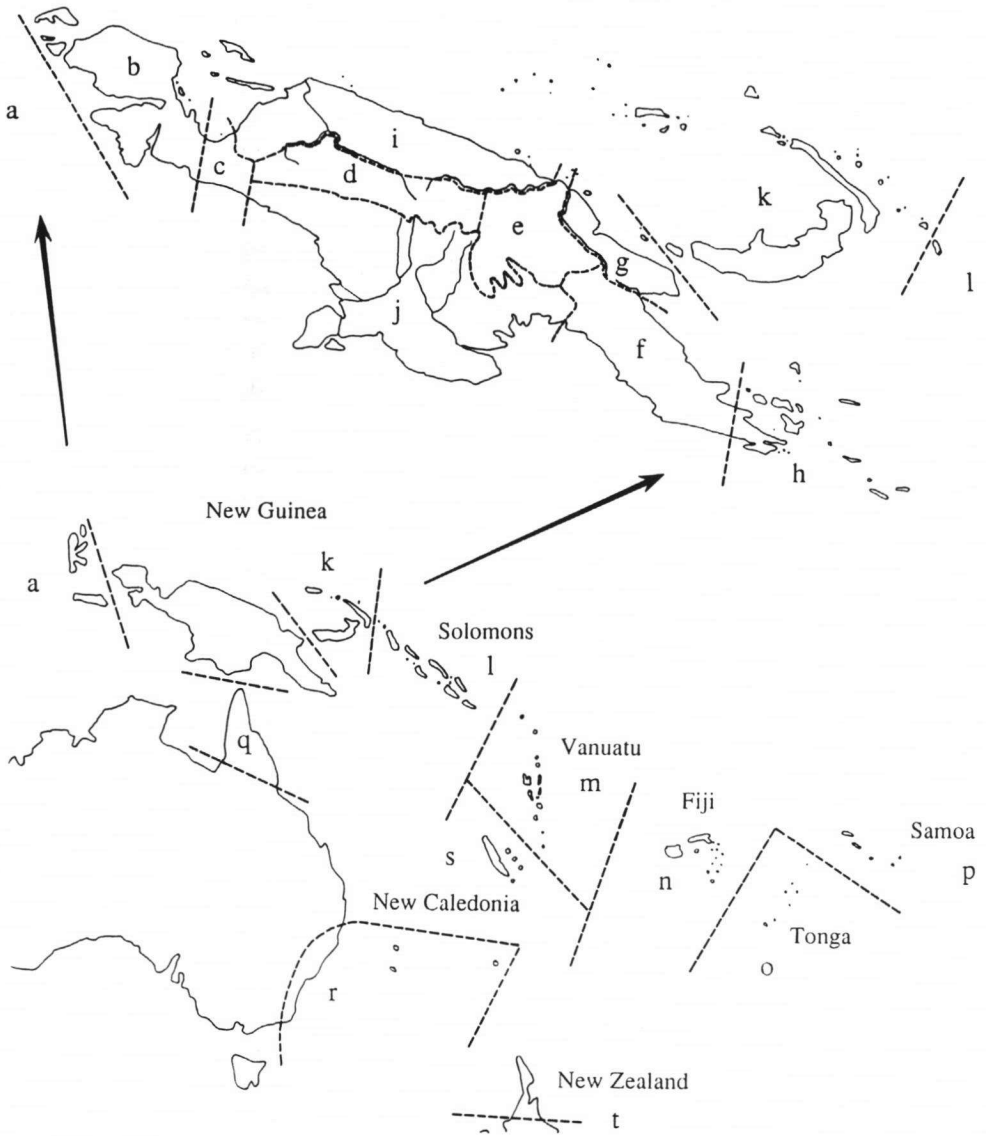

Map 1. Division of the area in range units.

For each species it can be established in which range units it occurs, see Table 19. Once this is done, the most frequently occurring combinations of range units each get a generalized range name, see Table 18.

Table 18. List of generalized ranges with the range units they may include. The range units which must score to qualify for a generalized range name are **bold**. If two range units are **bold**, at least one of them must score.

- a – Moluccas (M)
  - bc – Cendrawasih Peninsula (CEN).
  - c d e f g h** – Central Highlands (CH, not to be confused with the Central Province in Papua New Guinea).
  - c d** – Western part of the Central Highlands (WCH).
  - e** – Central part of the Central Highlands (CCH).
  - e f g h** – Eastern part of the Central Highlands (ECH).
  - f g h** – Eastern Peninsula (PEN).
  - g i** – Northern Highlands (NH).
  - h** – Milne Bay (MB).
  - j** – Southern Lowlands.
  - k l m n o p** – Solomon Islands to Samoa (OC).
  - q** – Queensland (Q).
  - r** – East Australia (EA).
  - s** – New Caledonia (NC).
  - t** – New Zealand.
- 

Species without a generalized range are considered as widespread, or they display ranges which are odd, in the sense that they are not shared with any other species. They need an ad hoc explanation.

This method has a disadvantage compared to the method of describing the range of the species in terms of the smallest known ranges: there is a chance that two strictly allopatric species with very small ranges score the same range unit, and are therefore not recognized as allopatric. However, in a generally poorly collected area such as New Guinea, species with very small ranges are generally known from a single collection only. The value of an assumption of allopatry based on such limited data is doubtful.

Unfortunately, this does not lead to relevant results for the revised species. Most sister species in the cladograms of Chapter 7 show largely overlapping ranges. Isolated species, or sister species which are allopatric, do occur in some cases, but no allopatric threesomes of the kind needed for an historical biogeographical analysis can be found. Apparently, this method does not lead to significant results in this case; it is impossible to make statements as to the historical biogeographic relationships between the various areas of endemism. However, obvious correlations between some patterns of distribution and the geology of the area exist. They invite ad hoc explanations, however speculative they may unavoidably be. The next chapters deal more closely with this matter.

Table 19. The range of the species revised, described in range units and generalized ranges.

Sections Species	Range units																Generalized range				
	a	b	c	d	e	f	g	h	i	j	k	l	m	n	o	p		q	r	s	t
<b>Section Adelopetalum</b>																					
<i>B. argyropus</i>																		r	s	t	Q
<i>B. boonjee</i>																		q			EA
<i>B. bracteatum</i>																		r			EA
<i>B. elizae</i>																		r			Q
<i>B. lageniforme</i>																		q			Q
<i>B. lilianae</i>																		q			Q
<i>B. lingulatum</i>																			s		NC
<i>B. newportii</i>																		q			Q
<b>Section Lepanthante</b>																					
<i>B. cruttwellii</i>				d	e	f	g														CH
<i>B. inquirendum</i>				d	e																CH
<i>B. lepanthiflorum</i>				d		f	g			i	j										
<i>B. leptophyllum</i>				d		f															CH
<i>B. antennatum</i>				d	e	f	g	h													CH
<i>B. erinaceum</i>				d	e	f				i											
<i>B. nephropetalum</i>					e		g			i											
<i>B. toranum</i>					e	f				i											
<i>B. baculiferum</i>			c	(or)					j											CEN or SL	
<i>B. bulliferum</i>			d	e			g			i	j		l								
<i>B. parabates</i>								h													MB
<i>B. quasimodo</i>				d						i	j										
<i>B. thersites</i>					e																CCH
<i>B. trachypus</i>					e	f				i											
<b>Section Macrouris</b>																					
<i>B. grammopoma</i>				d	e	f															CH
<i>B. sceliphron</i>					e	f															PEN
<i>B. callichroma</i>		b			e		g			i		k									
<i>B. cardiophyllum</i>					e																CCH
<i>B. cateorum</i>				d	e	f															CH
<i>B. chloranthum</i>				d	e	f	g				j	k									
<i>B. dekokkii</i>				d		f	g														CH
<i>B. dendrochiloides</i>				d	e	f	g														CH
<i>B. fonsflorum</i>					e																CCH
<i>B. graciliscapum</i>					e							l	m								CCH + OC
<i>B. kaniense</i>								g		i											NH
<i>B. levatii</i>												l	m								OC
<i>subsp. mischanthum</i>				d	e	f				i											
<i>B. macrourum</i>					e	f	g	h	i												
<i>B. mulderae</i>				d	e																CH
<i>B. muscicola</i>				d	e	f	g	h	i												

(Table 19 continued)

Sections	Range units																			Generalized range	
	a	b	c	d	e	f	g	h	i	j	k	l	m	n	o	p	q	r	s		t
(Sect. <i>Macrouris</i> contd)																					
<i>B. myon</i>				d	e	f															CH
<i>B. olivinum</i>		b	c	d	e	f															CEN + CH
subsp. <i>linguiferum</i>						f	h														PEN
<i>B. orbiculare</i>		b	c	d	e	f	g	h	i	j	k	l									
subsp. <i>cassideum</i>	a			d	e	g															
<i>B. oreodoxa</i>					e	f	g	h													ECH
<i>B. phormion</i>				d	e	f															CH
<i>B. pidacanthum</i>				d	e	f															CH
<i>B. scopa</i>				d	e	f															CH
<i>B. trifilum</i>	a			d	e	f	h	i													
subsp. <i>filisepalum</i>		c	d	e	f																CH
<i>B. desmotrichoides</i>	a			d	e	f			i	j											
<i>B. dichrotomum</i>				d	f	g						l	m								
<i>B. glaucum</i>									i												NH
<i>B. imitator</i>				d	f																CH
Section <i>Pelma</i>																					
<i>B. absconditum</i>	a			e	g							m							s		
subsp. <i>hastula</i>				d	e					j											
<i>B. ankylorhinon</i>				e	f	g															ECH
<i>B. bacilliferum</i>	a																				M
<i>B. colliferum</i>				d	e	f															CH
<i>B. fractiflexum</i>	a			d	e	f	g	h	i												
subsp. <i>olomonense</i>												l									OC
<i>B. gyaloglossum</i>				e																	CCH
<i>B. latipes</i>				d					i												
<i>B. leptoleucum</i>				d	e	f															CH
<i>B. leucothyrsus</i>					e	f	g														ECH
<i>B. macilentum</i>					e	f															ECH
<i>B. melanoxanthum</i>					f							l									PEN + OC
<i>B. mesodon</i>									i												NH
<i>B. mischobulbon</i>					e	f															ECH
<i>B. ochthochilum</i>					f																PEN
<i>B. oliganthum</i>					e	f	g														ECH
<i>B. pachytelos</i>				d	e	f	g	i													
<i>B. savaiense</i>													m	n	p						OC + NC
subsp. <i>gorumense</i>				d	e	f	g	h													CH
subsp. <i>subcubicum</i>	a			e			h	i	j	k											
<i>B. simile</i>				d	e	f	g														CH
<i>B. stipulaceum</i>				d	e	f		i	j												
<i>B. tanystiche</i>					e																CCH
<i>B. xanthochlamys</i>		b	c	d	e	f															CEN + CH

(Table 19 continued)

Sections Species	Range units																				Generalized range
	a	b	c	d	e	f	g	h	i	j	k	l	m	n	o	p	q	r	s	t	
<b>Section Peltopus</b>																					
<i>B. aechmophorum</i>				d	e	f															CH
<i>B. alveatum</i>						f															PEN
<i>B. ankylochele</i>				d	e																CH
<i>B. aphanopetalum</i>														n						s	ECH + OC
<i>B. artostigma</i>																					
<i>B. bliteum</i>					e																CCH
<i>B. brachypetalum</i>				d	e	f	g														CH
<i>B. brassii</i>				d	e	f															CH
<i>B. calviventer</i>					e	f	g	h													ECH
<i>B. cycloglossum</i>				d	e	f															CH
<i>B. discolor</i>				d	e	f	g	h	i												
subsp. <i>cubitale</i>						f															PEN
<i>B. hiljae</i>								h													MB
<i>B. inciferum</i>						f															PEN
<i>B. intersitum</i>					e	f															ECH
<i>B. kenai</i>					e																CCH
<i>B. lophoton</i>					e																CCH
<i>B. loroglossum</i>					e																CCH
<i>B. minutipetalum</i>					e	f		h	i												
<i>B. octarrhenipetalum</i>	b	c																			CEN
<i>B. origami</i>				d	e	f															CH
<i>B. ortalis</i>					e	f		h													ECH
<i>B. patella</i>					e																CCH
<i>B. peltopus</i>				d	e	f															CH
<i>B. plicatum</i>								g													NH
<i>B. ptychantyx</i>								g													NH
<i>B. reevei</i>				d	e	f															CH
<i>B. rhodoleucum</i>				d	e	f		h			k										CH + OC
<i>B. santoense</i>												m									OC
<i>B. scutiferum</i>				d	e	f															CH
<i>B. subapetalum</i>		c																			CEN
<i>B. systemochilum</i>				d																	WCH
<i>B. thelantyx</i>					e																CCH
<b>Section Uncifera</b>																					
<i>B. cylindrobulbum</i>	b	c	d	e	f	g	h	i		k	l										
<i>B. exiguum</i>																			r		EA
<i>B. laxum</i>					e	f	g				l										ECH + OC
<i>B. manobulbum</i>					e	f	g				l										ECH + OC
<i>B. bigibbum</i>				d	e																CH
<i>B. cavibulbum</i>				d																	WCH
<i>B. ochroleucum</i>	b		d	e	f	g	h	i	j	k											
<i>B. posticum</i>	b	c	d	e	f			i													

### 8.3. Coinciding species ranges and geotectonic blocks in and around New Guinea

Pigram & Davies (1987) present an overview over the geotectonic history of New Guinea. In their view, the Southern part of the island consists of the Northern margin of the Australian continent. Along this margin allochthonous material has accreted ever since the Australian continent started moving to the North, away from Antarctica, during the Cretaceous period some 100 MA ago. This allochthonous material is of various nature, for instance continental fragments, volcanic material or detritus from geotectonic events. It is amassed in larger bodies, i.e. terranes, which are separated by major faults. Each terrane has a unique geotectonic history. It should be noted that a terrane is not necessarily a sliver of continent adrift; most terranes do not contain any continental slivers at all.

The terranes so far identified are plotted in detail by Pigram & Davies (1987: 195, fig. 2). These terranes can be grouped according to the time of arrival at their present geological setting. They have arrived in more or less separate waves and some of them already fused to larger entities long before their moment of arrival. With some slight modifications, the various generations of terranes are indicated in Map 2.

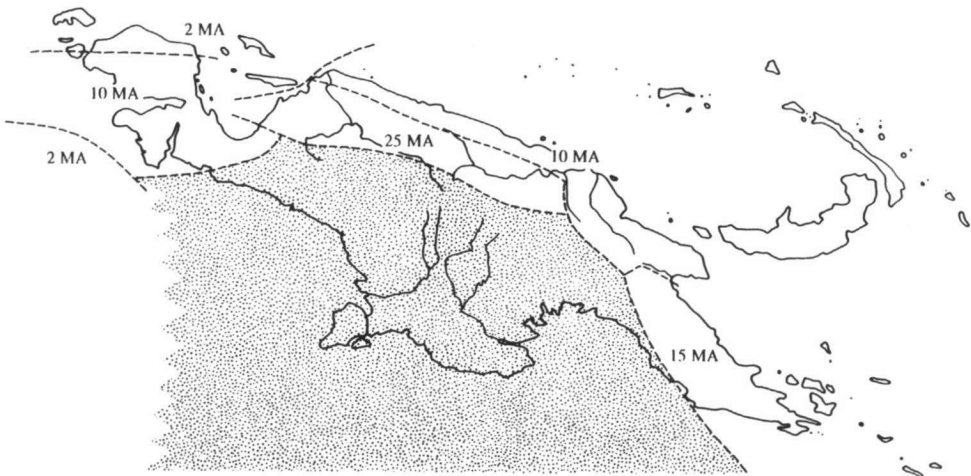

Map 2. Generations of terranes in New Guinea, according to Pigram & Davies (1987). The time of arrival of the various generations of terranes is given in millions of years (MA). The Australian continent is shaded.

A few of the boundaries between terranes, or between the various generations of terranes as given by Pigram & Davies more or less coincide with the range unit boundaries of *Bulbophyllum* species, as given in Map 1. These boundaries demarcate a number of areas in which endemic species occur:

1 — The East Papuan Composite Terrane (EPCT of Pigram & Davies, 1987: 198), reaching from the Bismarck Range to the Eastern end of New Guinea. This consists of a number of smaller terranes which accreted to a single large one before colliding, as a whole, with the Northern margin of the Australian continent, 15–25 MA ago. At present it is still surrounded by sea at three sides. It continues as the Papuan central mountain chain without

an interruption towards the West. It may have retained a few elements of its montane endemics, namely those species with the generalized range PEN. Possibly the species with the generalized range ECH (consisting of PEN plus range unit e) could also be included. Pigram & Davies (1987: 197) mention the possibility that the Schrader and Marum terranes, located in range unit e, are of EPCT-origin but have moved up 300 km to the West along major East–West strike-slip faults. If this holds true, Peninsular endemics may have moved with them towards the West.

Very few species are confined to portions of the EPCT only, see Map 3b, Eastern Peninsula (PEN) endemics: *B. parabates* has only been found on the D'Entrecasteaux Islands which consist of a separate terrane; *B. hiljeae* seems restricted to the Easternmost part of the Owen Stanley Range, which consists of the Kutu Terrane. Possibly the range of *B. alveatum* coincides with the Owen Stanley Terrane, and *B. ochthochilum* with the Dayman Terrane. Unfortunately, the latter species has been found twice only, in one locality).

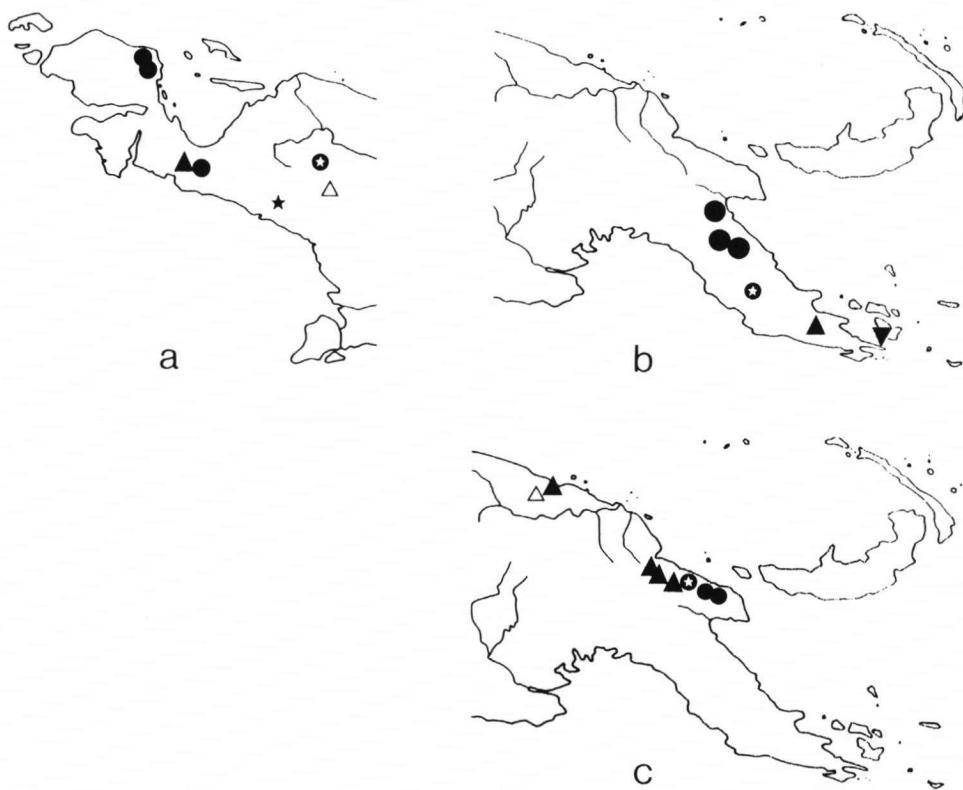

Map 3. Ranges of New Guinean species of *Bulbophyllum* which are confined to a small area only. — a: CEN endemics (black dots *B. octarrhenipetalum*; black triangle *B. subapetalum*; black star *B. baculiferum*), and WCH endemics (white star *B. cavibulbum*; white triangle *B. systemochilum*). — b: PEN endemics (black dots *B. alveatum*; black triangle *B. hiljeae*; inverted black triangle *B. parabates*; white star *B. ochthochilum*). — c: NH endemics (black dots *B. ptychantyx*; black triangles *B. kaniense*; white star *B. plicatum*; white triangle *B. glaucum*).

2 — The Finisterre Terrane (Pigram & Davies, 1987: 197) collided 10–15 MA ago with the margin of the Australian continent. Towards the North and the East it is still bordered by the sea, towards the South and the West by the wide valleys of the Markham and Ramu Rivers. The area is mainly inhabited by species which occur widely over the central mountain range as well as the Eastern Peninsula, but *B. plicatum* (found only once) and *B. ptychantyx* are confined to this area, see Map 3c, Northern Highlands (NH) endemics.

3 — Along the North coast of New Guinea, from the mouth of the Sepik River in the East to the Mamberamo River in the West, stretches a mountain chain in which several more allochthonous terranes have been identified. These remained separated from the New Guinean coast by a marine basin until after early Miocene; they have collided in approximately the same period as the Finisterre Terrane. *Bulbophyllum glaucum* may be endemic to this area (range unit i), but the species has been found only once. *Bulbophyllum kaniense* is restricted to both area units g (Finisterre Terrane) and i; see Map 3c, Northern Highlands (NH) endemics.

4 — The Cendrawasih Peninsula consists of a number of composite terranes. The Southern part arrived at its present position some 10–15 MA ago; the Northernmost part, including Waigeo Island, only 2–10 MA ago. As a whole it has a few endemics: *B. octarrhenipetalum*, *B. subapetalum* and possibly *B. baculiferum*, see Map 3a, Cendrawasih Peninsula (CEN) endemics.

Few species appear to occur in the Southern lowlands of New Guinea (area unit j); none of these are endemic with the possible exception of *B. baculiferum*; see Map 3a.

In the central mountain chain (area units cdefh) a few more areas of endemism may occur:

5 — Range unit e (generalized range CCH) possibly harbours a fair number of endemics. The range of a number of these is given in Map 4.

However, range unit e is the best collected area in New Guinea. Supposed endemics to this range unit may turn up in neighbouring range units as well. In fact a number of species, which are common in this area, have been found sporadically elsewhere, for example *B. reevei*; see Map 5.

At this stage, range unit e cannot be regarded as a true area of endemism. If ever the contrary can be demonstrated, an explanation based on the local geology may be difficult. It does not coincide very well with the terranes as distinguished by Pigram & Davies. In the East, it borders the EPCT. In the Northern part several terranes of different origin occur; among these are the Schrader and Marum Terranes which may be dislocated portions of EPCT-origin. The Southern part consists of shortened and deformed Australian continental margin.

6 — Range unit d (generalized range WCH). On the other hand, species recorded as endemics in the very poorly explored area d stand a greater chance of being true endemics. The species *B. cavibulbum* and *B. systemochilum* are examples. Both have been found on the Southwards thrust continental margin.

7 — However, the vast majority of the New Guinean species of *Bulbophyllum* appears impervious to the nature as well as the age of the geological substrates on which they occur. They are endemic to the central mountain chain of New Guinea, or at least to a considerable part of it (generalized range CH). Many species extend their range over area unit f, g, h,



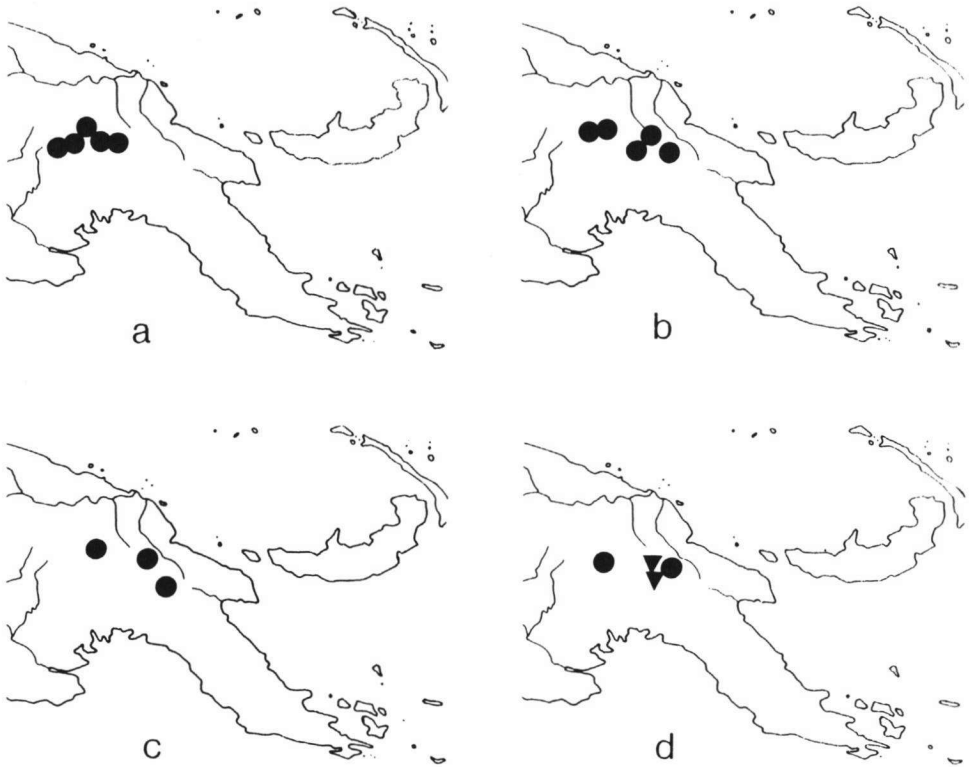

Map 4. Ranges of New Guinean species of *Bulbophyllum* which are endemic to range unit e (CCH). — a: *B. patella*. — b: *B. thelantyx*. — c: *B. bliteum*. — d: black dots *B. kenae*; black triangles *B. lophoton*.

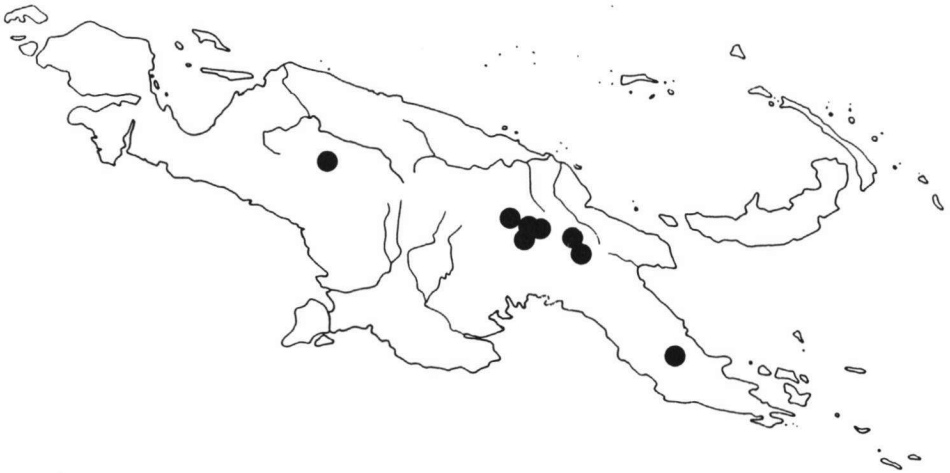

Map 5. Range of *Bulbophyllum reevei*.

and/or over the Cendrawasih Peninsula. Examples of this distribution pattern are *B. brassii*, a species restricted to alpine altitudes, or *B. olivinum*; see Map 6. Their range appears to be restricted by altitude rather than by anything else.

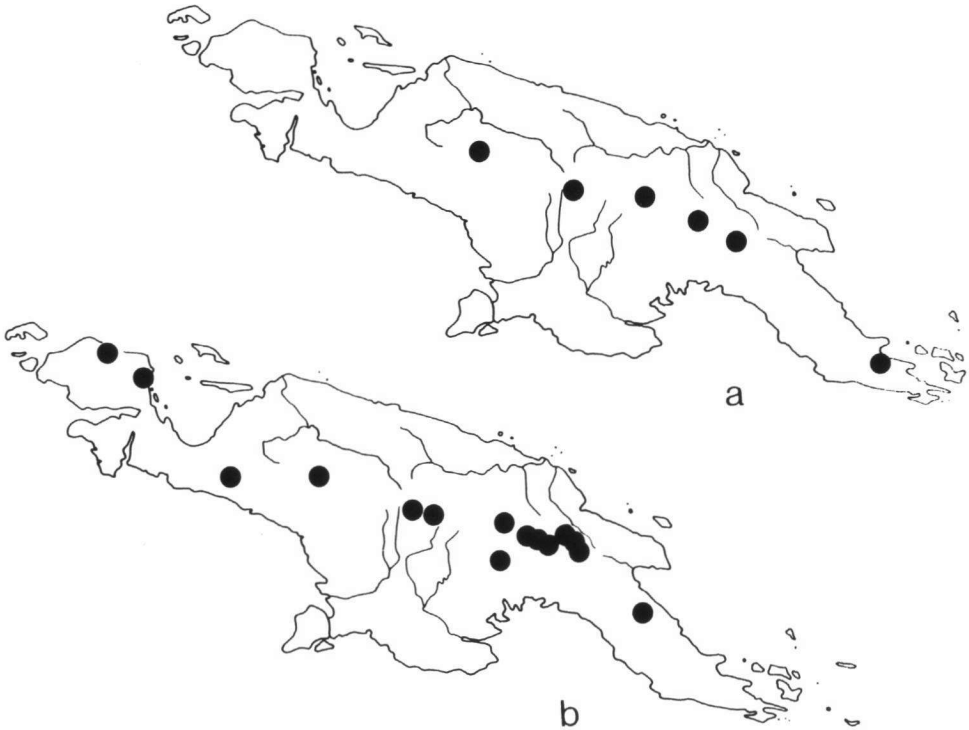

Map 6. Ranges of two widespread species in the central mountain chain of New Guinea (CH endemics). a: *B. brassii*. — b: *B. olivinum*.

8 — Among the revised species, a few endemics occur in the archipelagos surrounding New Guinea: the species *B. bacilliferum* in Ceram, and the taxa *B. levatii* subsp. *levatii*, *B. fractiflexum* subsp. *solomonense*, *B. savaiense* subsp. *savaiense*, and *B. santoense* in the West Pacific Islands (Bismarck Archipelago to Vanuatu).

#### 8.4. Ad hoc explanations regarding the observed patterns

*Conditions under which a terrane is able to preserve its endemic flora* — Apparently only a small number of the revised New Guinean *Bulbophyllum* species possibly reflect something of, geologically speaking, the allochthonous nature of parts of the area. Such species are mainly found in the Northern and Eastern parts of the island (areas of endemism 1 to 4). If they are true relics of endemic elements, this may be explained by the conditions under which a terrane is able to preserve its endemic flora, or part of it, after a geotectonic collision: 1) it must carry endemic species; 2) after collision the ecology should remain stable, or should only change at such a pace that at least a part of the endemics can survive

in situ, either as the original species or as newly evolved species; 3) the terrane should retain its isolation to such an extent that the endemics cannot disperse over a larger area. Time is important here; after a collision a terrane may retain its isolation for a while, but the arrival of new terranes will force it further over the continental margin. Its identity will be destroyed and it will become an indistinguishable part of a larger land mass.

The terranes occurring North of the Central Mountain chain as well as those which constitute the Eastern Peninsula (generalized ranges PEN, NH, CEN) comply best with the conditions outlined above. After their collision, they remained isolated by stretches of sea, or wide river valleys. They have not (yet) been uplifted to excessive height, so it can be assumed that the ecological environment did not change dramatically. Indeed, a number of probably terrane-bound endemic *Bulbophyllum* species occur here.

In the central mountain chain (generalized range CH, WCH, and probably ECH and CCH, as well as the range of most species which are regarded as widespread in Table 19) Pigram & Davies map a patchwork of allochthonous terranes. These have been thrust towards the South as nappes, one over another, as well as over the margin of the Australian continent. This has also caused an uplift of the continental margin. The continental margin as well as allochthonous terranes have been amalgamated to large mountain chains of considerable elevation and extension. Some terranes have also been displaced hundreds of kilometres along approximately East–West running strike slip faults (Pigram & Davies, 1987: 197; see also Burrett et al., 1991: fig. 6 a–g). It is not surprising that those topographic elements, which acted as barriers between terranes as far as orchids are concerned, have simply been wiped out. The environmental changes which resulted from the geological activity, such as an uplift to over 3000 m above sea-level, are likely to have initiated the numerous *Bulbophyllum* species which now inhabit the area at medium and high altitudes. The terranes have ceased to exist, and terrane-bound endemics do not occur here.

*A scenario* — In the West Pacific Islands (Bismarck Archipelago to Vanuatu) two effects can be observed: 1) distribution patterns of plant species which can be explained by an Eastward dispersion of species originating from New Guinea, and subsequent speciation at the periphery, such as described by Duffels (1983: 442) and Van Welzen (1989: 101); 2) a generally Westward movement, towards New Guinea, of the West Pacific Islands. These two effects counteract each other.

The central mountain range of New Guinea is inhabited by hundreds of *Bulbophyllum* species. Many of these are restricted to this area, others have a range spreading over the Cendrawasih Peninsula, over the northern mountain ranges, over the Eastern Peninsula, and/or over the West Pacific Islands. The following scenario is presented as an ad hoc explanation for these patterns: large-scale speciation has occurred in the central mountain range of New Guinea as a result of geotectonic instability of the area. A number of the species dispersed over the West Pacific Islands, where some of them evolved into new species. However, the generally Westward movement of the islands caused many of these West Pacific Island endemics, sooner or later, to find themselves back again on New Guinea. The degree of topographical and ecological isolation of the terrane determined to which extent they are still endemic at present.

*Speciation caused by geological activity* — A consequence of the scenario outlined above is that the present floristic wealth of the central mountain chain of New Guinea is not

older than the geotectonic collision events which caused the orogenesis, and started somewhere during the Eocene period.

Speciation caused by geological activity has been offered as an explanation for patterns of variability observed in the West Malesian *B. mutabile* (Blume) Lindl. by Vermeulen (1991: 73). This species is moderately variable over most of its range, but shows an excessive variability in the mountain ranges of North Borneo, including Mt Kinabalu. A number of odd characters in every possible combination have been observed there. It is assumed that this is caused by recent geological activity in the area (strong uplifting since the late Miocene period, some 8 MA ago according to Myers, 1978: 91). This caused rapid changes and diversification of habitats. The environmental constraint on the species, as exists in geologically more stable areas, diminished. Odd characters, which otherwise could not be retained under a continuous selective pressure, now got a chance. This has resulted in a local increase in evolutionary speed in a relatively brief period of time, while elsewhere in the range of the species an evolutionary stasis continues. Van Welzen (1989: 48) gives further examples of groups of plants showing patterns of variability, or of speciation, pointing to a phenomenon which was originally presented by Eldredge & Gould (1972) as the theory of Punctuated Equilibria.

#### 8.5. Areas of endemism elsewhere

Australia is inhabited by most species of sect. *Adelopetalum* as well as by *B. exiguum*. These species show two well separated areas of endemism: Queensland and Southeast Australia. New Caledonia has only two species: *B. lingulatum* (closest relatives in Queensland) and *B. argyropus* (closest relatives live in Southeast Australia).

### 9. CULTIVATION

In general, *Bulbophyllum* species can be grown under approximately similar conditions as most epiphytic orchids.

Most of the living plants used for the present research are grown successfully in a temperate greenhouse. Even species from fairly high altitudes appear to adapt easily to temperate conditions. Only very few truly alpine species (those originating from altitudes over 3000 m asl) have been in cultivation so far. The results are not promising: even in a cold greenhouse they are very difficult to keep alive.

Small species, species with long rhizomes, as well as species with pendulous rhizomes are mounted on preferably thin slabs of tree-fern roots. Species with thin roots and soft leaves, or newly imported plants which have suffered dehydration during transport, are supplied with a mixture of *Sphagnum*, tree-fern roots and dry beech leaves between their roots, or between the plant and the substratum. A good aeration of the substratum is important; plants easily start ailing if this is impeded by the growth of algae. This may happen if the tree-fern slabs are too dense, or decaying. Often, the first symptoms are roots which suddenly stop growing once they touch the substratum. The abundant growth of fine moss on the slabs seems to do little harm; if it is removed it appears that very healthy roots often creep underneath. Excellent results have been achieved by Mr. P. Jongejan (Amersfoort, The Netherlands) with approximately 5 mm thick slabs of tree-fern, on the backside glued

to a slab of styropor (polystyrol foam). The back surface of the styropor is painted to prevent the decomposition of the plastic by sunlight. The plants are mounted with U-shaped staples of thin stainless steel wire which go through the tree-fern and stick into the styropor. The ends of the staples should be well sharpened by oblique cutting of the wire. If they are not sharp enough the staples will not hold properly.

Plants with short rhizomes are grown in plastic pots, planted in a loosely packed mixture of *Sphagnum*, tree-fern root and dry beech leaves, with a generous amount of coarse potsherds at the bottom of the pot for proper drainage.

Most species grow best if kept moderately damp, with regular watering and spraying and in a humid atmosphere. However, occasional dry spells, as well as a proper ventilation, particularly after watering the plants, appear very important to keep them healthy.

As the most damaging pests, slugs and cockroaches can be mentioned. To both the young shoots, young inflorescences and the flowers of some species seem to be a delicacy.

Some special requirements for a few species are listed below:

Sect. *Adelopetalum*. – *Bulbophyllum argyropus* and *B. elizae* have been grown successfully under comparatively dry conditions, receiving plenty of light. According to Dockrill (1969) *B. bracteatum* as well as *B. lilianae* also prefer spots which are well exposed to light.

Sect. *Macrouris*. – *Bulbophyllum dichotomum* may grow to a considerable size in a few years, but hardly ever produces flowers.

Sect. *Peltopus*. – Particularly the larger species of this section, such as *B. ankylochele*, *B. hiljeae*, *B. peltopus*, *B. reevei*, *B. rhodoleucum*, occur as epiphytes in the undergrowth of montane forests, or as terrestrials in the leaf-litter on the forest floor. They grow in heavily shaded and permanently humid conditions. However, even if these conditions are simulated carefully in the greenhouse, these species are difficult to grow. They may do well for some time but, particularly during the winter months, suddenly rot away in a few weeks. Keeping the plants under less humid conditions will only cause them to shrivel away slowly. Their flowers and root-tips are also particularly vulnerable for snails: a richly flowering plant of *B. ankylochele* once had all its flowers ravaged in a single night. The smaller species of the section, such as *B. discolor* and *B. intersitum* are much easier to grow and may develop into nice, abundantly flowering polsters in a few years.

Sect. *Uncifera*. – *Bulbophyllum exiguum* originates from a more temperate and seasonal climate, a fact which should be kept in mind when cultivating the plant.

## 10. ACKNOWLEDGEMENTS

The following institutions have kindly made material available to the author (those marked with an \* have been visited): AMES, B, BM\*, BO\*, BRI, CAN, E, K\*, L\*, LAE, MEL, NY, P, QRS, S, U\*, W, WRSL. A number of these broad-mindedly agreed to send a large part of their collection of *Bulbophyllum* on loan, to enable the author to sort out from the unidentified material the specimens needed for the revisions.

As explained above, spirit samples are very important when revising groups of orchids. Unfortunately they are poorly represented in the current collections. For a decade now, a number of people have helped to gather some 3000 spirit samples of species of *Bulbophyllum*.

Mr. Peter Jongejan (Amersfoort, The Netherlands) is responsible for some 2200 of these samples. He took them from plants which have been collected during a number of trips to Papua New Guinea and which

are expertly grown in his private greenhouse. The documentation of these samples includes a large collection of colour slides of superb quality. He was also helpful to compile the chapter on cultivation.

A second large collection of living plants is kept in the Botanical Garden in Leiden, under the care of Messrs. Ard Vogel, André Mulder and Peter Beckhuizen.

Together with the staff of the Mount Gahavisuka Provincial Park, the Revd. Canon Norman E.G. Cruttwell (Lingfield, England) spent a lot of time making samples of the *Bulbophyllum* species growing in the park, as well as in neighbouring mountain ranges.

Mr. Peter O'Byrne (Singapore) made a number of spirit samples of plants mainly collected from the Papua New Guinean lowlands, and grown in his garden.

Mr. Andrew Bacon (Papua New Guinea) collected several samples during trips to the remote parts of Papua New Guinea.

Dr. M.A. Clements provided data on Australian *Bulbophyllum* species.

Dr. P.J. Cribb (Kew), Mrs. H. Duistermaat, Dr. R. Geesink, Prof. Dr. C. Kalkman, Dr. M.C. Roos, Dr. E.F. de Vogel, and Dr. P.C. van Welzen (all Leiden) read the manuscript, or parts of it, and supplied valuable comments. Mr. A. Schuiteman informed me that *Phreatia globulosa* could well be a *Bulbophyllum* species. Dr. J.F. Veldkamp (L) provided a number of diagnoses in Latin, Mrs. Nelleke Werker and Mrs. Emma van Nieuwkoop did the typesetting and lay-out of this volume.

The help of all the people and institutions mentioned above is gratefully acknowledged here.

## 11. REFERENCES

- Audley Charles, M.G. 1987. Dispersal of Gondwanaland: relevance to evolution of the Angiosperms. In: T.C. Whitmore (ed.), *Biogeographical evolution of the Malay Archipelago*: 5–25. Oxford.
- Bentham, G. 1861. On the species and genera of plants, considered with reference to their practical application to systematic botany. *Natural History Review* n.s. 1: 133–151.
- Brooks, D.R. 1984. Quantitative parsimony. In: T. Duncan & T.F. Stuessy (eds.), *Cladistics: perspectives on the reconstruction of evolutionary history*: 119–132. New York.
- Burrett, C., N. Duhig, R. Berry & R. Varne. 1991. Asian and South-western Pacific continental terranes derived from Gondwana, and their biogeographic significance. *Austr. Syst. Bot.* 4: 13–24.
- Danesch, O. & E. Danesch. 1972. *Orchideen Europas – Ophrys Hybriden*. Bern.
- Dockrill, A.W. 1969. *Australian Indigenous Orchids 1*. Society for growing Australian plants, Sydney.
- Dressler, R.L. 1981. *The Orchids – Natural history and classification*. Harvard Univ. Press, Cambridge, Mass.
- Duffels, J.P. 1983. Distribution patterns of Oriental Cicadoidea (Homoptera) East of Wallace's Line and plate tectonics. *GeoJournal* 7 (6): 491–498.
- Eldredge N. & S.J. Gould. 1972. Punctuated equilibria: an alternative to phyletic gradualism. In: T.J.M. Schopf, *Models in Paleobiology*: 82–115. San Francisco.
- Farris, J.S. 1988. Hennig86 reference, version 1.5. Univ. of Stony Brook, New York.
- Farris, J.S. 1989. The retention index and the rescaled consistency index. *Cladistics* 5: 417–419.
- Garay, L.A. & W. Kittredge. 1985. Notes from the Ames orchid herbarium. *Bot. Mus. Leafl. Harv. Univ.* 30 (3): 47–59.
- Geesink, R. 1987. Structure of keys for identification. In: E.F. De Vogel (ed.), *Manual of herbarium taxonomy, theory and practice*.
- Geesink, R. & M. Zandee (In prep.) The Redundancy Quotient (RQ): an algorithm.
- George, W. 1987. Complex origins. In: T.C. Whitmore (ed.), *Biogeographical evolution of the Malay Archipelago*: 119–131. Oxford.
- Myers, L.C. 1978. Geomorphology. In: M. Luping et al., *Kinabalu, summit of Borneo*: 91–97. Kota Kinabalu.
- Nelson, G.J. 1972. Phylogenetic relationship and classification. *Syst. Zool.* 21: 227–231.
- Nelson, G.J. 1974. Classification as an expression of phylogenetic relationships. *Syst. Zool.* 22: 344–359.
- Parris, B.S. 1985. Ecological aspects of distribution and speciation of Old World tropical ferns. *Proc. Roy. Soc. Edinb.* 86: 341–346.

- Pigram, C.J. & H.L. Davies. 1987. Terranes and the accretion history of the New Guinea orogen. *J. Austral. Geol. & Geoph.* 10: 193–211.
- Ridley, H.N. 1916. Report on the botany of the Wollaston Expedition to Dutch New Guinea, 1912–13. *Trans. Linn. Soc. II*, 9: 1–269.
- Schlechter, R. 1911–1914. Die Orchidaceen von Deutsch-Neu-Guinea. Fedde, Rep., Beih. 1.
- Smith, J.J. 1911–1935. Die Orchideen von Niederländisch-Neu-Guinea. *Nova Guinea* 8, 1 (1911) 1–161; 8, 3 (1911) 521–611; idem 12, 1 (1913) 1–108; 12, 3 (1915) 173–272; 12, 4 (1916) 273–477; idem 14, 3 (1929) 337–516; idem 18, 1 (1935) 9–85.
- Smith, J.J. 1914. Neue Orchideen des Malaiischen Archipels VII. *Bull. Jard. Bot. Buitenzorg II*, 13: 1–77.
- Seidenfaden, G. 1973. Notes on Cirrhopetalum. *Dansk Bot. Ark.* 29: 8–260.
- Seidenfaden, G. 1976. Contributions to the orchid flora of Thailand VII. *Bot. Tidsskr.* 71: 1–30.
- Seidenfaden, G. 1986. Orchid genera in Thailand XIII. Thirty-three Epidendroid genera. *Opera Bot.* 89: 1–200.
- Sleumer, H. 1966–1967. Ericaceae. *Flora Malesiana I*, 6: 469–914.
- Steenis, C.G.G.J. van. 1950. The delimitation of Malaysia and its main plant geographical divisions. *Flora Malesiana I*, 1: LXX–LXXXV.
- Steenis, C.G.G.J. van. 1979. Plant geography of East Malesia. *Bot. J. Linn. Soc.* 79: 97–178.
- Swofford, D.L. 1985. PAUP. Phylogenetic analysis using parsimony, version 2.4. Illinois Natural History Survey, Champaign, Illinois.
- Turner, H. 1992. A revision of the orchid genera *Ania*, *Hancockia*, *Mischobulbum*, and *Tainia*. *Orch. Monogr.* 6: 43–100.
- Vermeulen, J.J. 1987. A taxonomic revision of the continental African Bulbophyllinae. *Orch. Monogr.* 2.
- Vermeulen, J.J. 1991. Orchids of Borneo 2 – Bulbophyllum. Bentham-Moxon Trust, Kew & Toihaan Publishing Company, Sabah.
- Welzen, P.C. van. 1990. *Guioa* Cav. (Sapindaceae): taxonomy, phylogeny, and historical biogeography. *Leiden Bot. Series* 12.
- Wiley, E.O. 1981. *Phylogenetics – The theory and practice of phylogenetic systematics*. New York.
- Zandee, M. 1987. A computing environment for cladistic analysis. In: P. Hovenkamp (ed.), *Systematics and evolution: a matter of diversity*: 111–140. Utrecht.
- Zandee, M. 1988. A user manual for CAFCA/PC (version 1.9.6). Institute of Theoretical Biology, University of Leiden.
- Zandee, M. & R. Geesink. 1987. Phylogenetics and Legumes: a desire for the impossible? In: C.H. Stirton (ed.), *Advances in Legume systematics*, part 3: 131–167. Kew.

## 12. REVISIONS

### BULBOPHYLLUM

*Bulbophyllum* Thouars, Orch. Iles Afr. (1822) t. esp. 3, sub u, nomen conservandum. — Type species: *Bulbophyllum nutans* Thouars, typus conservandum.

*Adelopetalum* Fitzg., J. Bot. 29 (1891) 152. — Type species: *Adelopetalum bracteatum* (F.M. Bailey) Fitzg. (= *Bulbophyllum b.* F.M. Bailey).

*Dactylorhynchus* Schltr., Fedde, Rep. Beih. 1 (1913) 890. — Type species: *Dactylorhynchus flavescens* Schltr. (= *Bulbophyllum latipes* J.J. Smith).

Notes – 1. Only generic synonyms are given of which the type species is included in one of the sections revised in this volume.

2. The following abbreviations are used in the text: adx. = adaxially; abx. = abaxially; asl. = above sealevel; approx. = approximate(ly). — The months are indicated with a number: 1 = January, 2 = February, etc.

3. The number of pollinia is easiest to check if the pollinia are immersed in water or alcohol.

#### KEY TO THE SECTIONS REVISED IN THIS VOLUME

- 1a. Stelidia with a distinct, approx. downwards directed, straight or recurved, semi-elliptic, generally rounded tooth along their lower margin, very close to the tip (in case the stelidia are absent check the lower margins of the column, at the level of the rostellum; see Fig. 21) . . . . . Section **Uncifera** (page 176)
- b. Stelidia either without a tooth along their lower margin; or with a deltoid or triangular tooth, or with a tooth lower down along their margin . . . . . 2
- 2a. Pollinia 4 (look carefully, the inner pair may be small, or very thin and therefore inconspicuous); or pollinia 2, but then median sepal with two distinct folds along its midvein, near its base . . . . . 3
- b. Pollinia 2, median sepal without folds along its midvein, near its base . . . . . 10

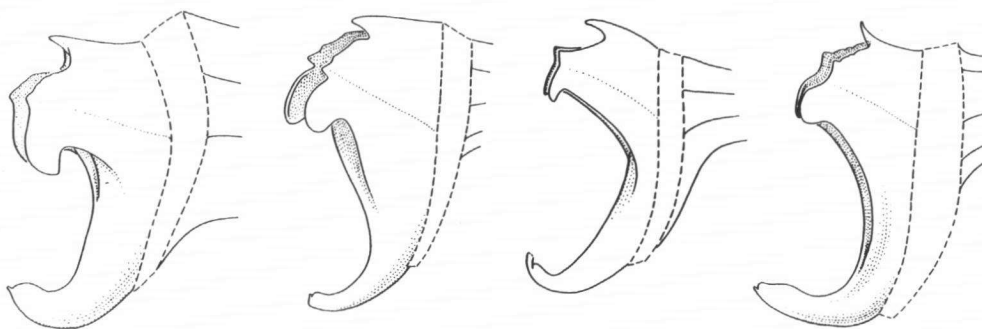

Fig. 21. Explanatory sketches with the key to the sections.



- 3a. Inflorescence with 1 flower, an aborted second flower may be present as a hardly differentiated strip of tissue protruding from the floral bract . . . . . 4
- b. Inflorescence with 2 flowers or more; or inflorescence with 1 flower as well as 1 or more developing flower buds . . . . . 7
- 4a. Rhizome creeping; each pseudobulb attached to the substratum with one or a few roots  
Section **Peltopus** (page 145)
- b. Rhizome erect, patent or pendulous, attached to the substratum at its very base only . . . . . 5
- 5a. Median sepal 1.4–5 mm long . . . . . Section **Pelma** (page 121)
- b. Median sepal 8–18 mm long . . . . . 6
- 6a. Lip with a conical callosity on the adaxial side, close to the tip  
Section **Pelma** (*B. ochthochilum*, page 137)
- b. Lip without a conical callosity on the adaxial side, close to the tip  
Section **Peltopus** (page 145)
- 7a. (3) Rhizome creeping; each pseudobulb attached to the substratum with one or a few roots . . . . . 8
- b. Rhizome erect, patent or pendulous, attached to the substratum at its base only . . . . . 9
- 8a. Base of the stigma with a distinct tooth, protruding from the face of the column in lateral view  
Section **Macrouris** (*B. callichroma*, *B. chloranthum*, page 95 and 98 resp.)
- b. Base of the stigma without teeth protruding from the face of the column  
Section **Adelopetalum** (page 66)
- 9a. (7) Rhizome scales distinctly longer than the internodes they cover, thus covering the entire rhizome (check a recently developed, fully grown portion of the plant)  
Section **Pelma** (page 121)
- b. Rhizome scales shorter than or as long as the internodes they cover, leaving bare portions of the rhizome  
Section **Macrouris** (*B. desmotrichoides*, *B. imitator*, page 117 and 119 resp.)
- 10a. (2) Tip of the median sepal with a fleshy, subulate projection, often ending in a thickened knob . . . . . Section **Lepanthanthe** (page 73)
- b. Tip of the median sepal obtuse to long caudate, but without a thickened, subulate projection . . . . . 11
- 11a. Rhizome creeping, each pseudobulb attached to the substratum with one or a few roots, *and* base of the stigma not protruding from the face of the column in lateral view (a slight swelling may be present lower down on the column foot)  
Section **Adelopetalum** (page 66)
- b. *Either* rhizome erect, patent or pendulous, attached to the substratum at its base only, *or* base of the stigma protruding from the face of the column in lateral view, or with 1–3 protruding teeth, *or* both characters mentioned present  
Section **Macrouris** (page 89)

**Section Adelopetalum** (Fitzg.) J.J. Vermeulen, *stat. nov.*

*Adelopetalum* Fitzg., J. Bot. 29 (1891) 152. — Type species: *Adelopetalum bracteatum* Fitzg. (= *B. bracteatum* F.M. Bailey).

*Rhizome* creeping; rhizome scales shorter or longer than the internodes they cover. *Roots* sprouting along the entire rhizome, or below the pseudobulbs only. *Inflorescence* with 2 or more flowers, sometimes with 1 flower (*liliana*, *lingulatum*). *Median sepal*: tip emarginate to shortly acuminate. *Petals* distinct, not very small. *Lip* without lobes, or with very small lateral lobes (*lingulatum*, *newportii*); lip above the ligament without a concavity with two teeth in front. *Column*: rostellum not protruding in lateral view; base of the stigma not protruding in lateral view, without teeth; column-foot without accessories (with a slight swelling approx. half-way in *argyropus*). *Stelidia* present, without a tooth along their lower margin, or with a downwards or forwards directed straight, deltoid to triangular, rounded to acute tooth along their lower margin. *Pollinia* 2 or 4, if 4 the inner pair more than half as long as the outer pair. *Stipes* absent.

Notes – 1. *Thelychiton argyropus* Endl. (= *Bulbophyllum a.* Reichb. f.) is one of the syntype species of the genus *Thelychiton* Endl., Prod. Fl. Norf. (1833) 32. Clements (Austr. Orch. Research 1, 1989, 45) has chosen *T. macropus* Endl. as lectotype, which is a *Dendrobium* species.

2. Sect. *Adelopetalum* is most similar to sect. *Macrouris*. It differs in the base of the stigma which does not protrude from the face of the column. In Series C of sect. *Macrouris* a number of species has been included which show the same character state, but these have a patent rhizome. This does not occur in sect. *Adelopetalum*.

3. More information on the Australian species of this section can be found in Dockrill (Austr. Indig. Orchids, 1969, 531–533 and 567–575), as well as in Clements (Austr. Orch. Research 1, 1989, 14–19). All data given here for these species have been completed from these sources, unless stated otherwise.

KEY TO THE SPECIES OF SECTION ADELOPETALUM

- 1a. Pollinia 2 . . . . . 2
- b. Pollinia 4, the inner pair distinct, more than half as long as the outer pair . . . . . 4
- 2a. Lip adx. in the basal half with two distinct, short ridges close to the median line
  - 1. **B. argyropus**
  - b. Lip adx. in the basal half without two short ridges . . . . . 3
- 3a. Leaf index 5–10.5. Inflorescence with 2–4 flowers. Lip adx. in the basal half with a narrow median ridge, which is well separated from the lateral sides by distinct furrows . . . . . 2. **B. boonjee**
- b. Leaf index 1.8–3.8. Inflorescence with 13–25 flowers. Lip adx. in the basal half with a wide and flat median thickening which is not separated from the lateral sides by furrows . . . . . 3. **B. bracteatum**
- 4a. (1) Lateral sepals 12–22 mm long. Stelidia without a distinct wing or tooth along the lower margin . . . . . 4. **B. elizae**
- b. Lateral sepals 4–8.5 mm long. Stelidia with a distinct tooth or wing along the lower margin . . . . . 5

- 5a. Ovary distinctly verrucose. Stelidia with a downwards or slightly forwards pointing deltoid wing along the lower margin . . . . . 6
- b. Ovary approx. glabrous. Stelidia with a small, distinctly forwards pointing tooth along the lower margin . . . . . 7
- 6a. Lip adx. towards the base with a median slit with thickened margins  
**5. B. lageniforme**
- b. Lip adx. towards the base without a median slit . . . . . **6. B. lillianae**
- 7a. (5) Lip adx. entirely glabrous. Teeth along the margin of the lip recurved, pointing towards the abaxial side of the lip . . . . . **7. B. lingulatum**
- b. Lip adx. towards the base papillose. Teeth along the margin of the lip either absent, or present and approx. erect or folded inwards towards the adaxial side of the lip  
**8. B. newportii**

**1. *Bulbophyllum argyropus* (Endl.) Reichb. f. – Fig. 26.**

*Bulbophyllum argyropus* (Endl.) Reichb. f., *Linnaea* 41 (1876) 42. – *Thelychiton argyropus* Endl., *Prod. Fl. Norf.* (1833) 32. — Type: Bauer s.n. (holo W; iso K).

*Bulbophyllum tuberculatum* Colenso, *Trans. & Proc. N.Z. Inst.* 16 (1884) 336; id. 22 (1890) 488. — Type: Hamilton s.n. (1883) (not seen; possibly as 'com. Colenso, 1890' in K).

*Bulbophyllum corythium* Hallé, *Adansonia sér.* 2, 20 (1981) 357. — Type: Bégaud in MacKee 36924 (P).

*Rhizome* 0.8–1 mm diam. *Pseudobulbs* ovoid to almost globular, or obovoid with a distinct knob on each rib, close to the tip, 0.2–0.6 cm apart, 0.4–1(–1.5) by 0.2–0.7 cm, not laterally flattened. *Petiole* 0.5–3 mm. *Leaf blade* elliptic, 0.7–2.2 by 0.3–0.7 cm, index 1.7–7, tip obtuse to acute. *Inflorescence* 1–3.5 cm, 2–6-flowered. *Peduncle* 0.6–2.0 cm, verrucose; bracts 3, the longest 3–3.5 mm. *Rachis* erect, 0.2–1.8 cm. *Floral bracts* ovate, 1.5–3 mm, tip acute. *Pedicel and ovary* 2–2.5 mm, with the node c. 0.8 mm from the floral bract; ovary verrucose. *Flowers* all open at the time, hardly opening. *Median sepal* ovate to triangular, 3–4.2 by 1–1.3 mm, index 2.5–3.2, tip acute; rather thick; glabrous. *Lateral sepals* oblique, 2.8–4.5 by 1.5–2.5 mm, index 1.5–1.8, otherwise as the median sepal. *Petals* oblique, elliptic, 2–2.8 by 0.7–0.9 mm, index 2.2–3.5, tip obtuse to acute; margins glabrous or finely papillose; rather thin; surface glabrous. *Lip* curved at the base, general outline ovate to elliptic, 2.3–2.7 by 0.9–1.3 mm, index 2–2.3 (not spread), tip obtuse to acute; thick; glabrous; adx. concave towards the base, with 2 small ridges close to the median line in the basal half; abx. with an inconspicuous, truncate median ridge. *Column* from ovary to the tip of the stelidia 0.5–0.8 mm; stigma not protruding at its base, elliptic; column-foot with a slight swelling. *Stelidia* short, deltoid, tip obtuse to acute; with an inconspicuous to distinct, deltoid, obtuse to acute wing along the lower margin. *Anther* abx. with a ridge towards its base; front margin somewhat protruding. *Pollinia* 2.

*Colours* – Pseudobulbs yellowish green, often suffused with red. Leaves green. Sepals and petals pale greenish, yellow or white, with or without pinkish veins. Lip yellow to red.

*Ecology* – Epiphyte in primary, subtropical as well as temperate, humid forest. Sometimes as a lithophyte. Alt. 200–1000 m. asl. Flowering observed in 2, 4, 5, 9.

*Distribution* – NEW CALEDONIA. – NEW ZEALAND. North Island; northern part of South Island. – AUSTRALIA. Queensland (SE part); New South Wales; Norfolk and Lord Howe Islands.

Notes – 1. Characterized by the two small ridges present on the adaxial surface of the lip.

2. Mature pseudobulbs usually bear a crown of distinct knobs around the attachment of the leaf. Specimens from New Zealand, however, all have smooth pseudobulbs, and are self pollinating (Clements, pers. comm.). Otherwise they are not different. Therefore they are not regarded as a separate species here.

3. The New Caledonian material, including the type of *Bulbophyllum corythium*, is almost identical in all characters with the type material of *B. argopyrus*, from Norfolk Island.

## 2. *Bulbophyllum boonjee* Gray & Jones – Fig 27.

*Bulbophyllum boonjee* Gray & Jones, *Orchadian* 8 (1984) 40. — Type: Gray 1005a (QRS).

*Rhizome* c. 0.8 mm diam. *Pseudobulbs* approx. lenticular, with 3–4 edges, 0.15–0.4 cm apart, 0.3–0.8 by 0.3–0.7 cm, not laterally flattened. *Petiole* 2.5–4 mm. *Leaf blade* elliptic to obovate, 1.2–4.2 by 0.2–0.4 cm, index 5–11, tip (sub)acute. *Inflorescence* 1.5–3 cm, 2–4-flowered. *Peduncle* 1.3–2.7 cm, slightly and finely verrucose towards the tip; bracts 3, the longest c. 2.5 mm, the upper patent. *Rachis* erect, 0.2–0.3 cm. *Floral bracts* ovate, 1.8–2 mm, tip acute. *Pedicel and ovary* 3–4 mm, with the node c. 0.3 mm from the floral bract; ovary verrucose. *Flowers* all open at the time, moderately opening. *Median sepal* ovate to elliptic, 3–4 by 1–2 mm, index 2–3, tip shortly acuminate; rather thick; glabrous. *Lateral sepals* oblique, ovate, 3–4.5 by 2.5–3.5 mm, index 1.1–1.6; otherwise as the median sepal. *Petals* oblique, ovate, 2–3 by 1.3–2 mm, index 1.1–1.5; tip acute; rather thin; otherwise as the median sepal. *Lip* curved, general outline elliptic, c. 2.5 by 1–1.3 mm, index 2–2.5 (not spread), tip rounded; margins finely papillose towards the base; thick; adx. with a triangular concavity just above the ligament, with a narrow median thickening in the basal half which is separated from the lateral sides by distinct furrows, surface papillose towards the margins in the basal half; abx. with an inconspicuous, truncate median ridge, surface glabrous. *Column* from ovary to the tip of the stelia 1–1.2 mm; stigma not protruding at its base, orbicular; column-foot without accessories. *Stelia* small, triangular, tip acute; with a small, deltoid, rounded tooth along the lower margin. *Anther* abx. with a distinct ridge towards its base; front margin protruding. *Pollinia* 2.

Colours – Sepals dark purple, lighter towards the margin (Clements, pers. comm.).

Ecology – Epiphyte in primary forest. Alt. c. 720 m asl. Flowering mainly 1–2, 9–12.

Distribution – AUSTRALIA. Queensland, (Atherton and Windsor Tablelands; Clements, pers. comm.).

Note – *Bulbophyllum argopyrus* as well as *B. bracteatum* both have distinctively less dorsoventrally flattened pseudobulbs (Clements, pers. comm.). The first also differs in having two small keels on the adaxial side of the lip; the latter in being much larger, and in not having a narrow median thickening on the adaxial side of the lip.

## 3. *Bulbophyllum bracteatum* F.M. Bailey – Fig. 28.

*Bulbophyllum bracteatum* F.M. Bailey, *Bull. Dep. Agric. Queensl.* 13 (Bot. 4) (Dec. 1891) 17. — Type: Schneider s.n. (BRI).

*Adelopetalum bracteatum* Fitzg., *J. Bot.* 29 (1891) 152. — Type: F.M. Bailey s.n. (not seen); lectotype Fitzgerald's plate at CBG (not seen), designated by Clements, 1989).

*Rhizome* 1–1.8 mm diam. *Pseudobulbs* ovoid to orbicular to globular, 0.4–1 cm apart, 0.7–1 by 0.7–1.2 cm, not laterally flattened, ribs often with somewhat crenulated edges. *Petiole* 0.5–1 mm. *Leaf blade* ovate to elliptic, 1.3–4.5 by 0.7–1.2 cm, index 1.8–3.8, tip approx. acute. *Inflorescence* 5–10 cm, 13–25-flowered. *Peduncle* 4–6 cm; bracts 9, the longest 6–7 mm, the upper distinctly patent. *Rachis* erect or arching, 2–3 cm. *Floral bracts* ovate, 1.3–2 mm, tip acute. *Pedicel and ovary* 2–3 mm; ovary glabrous. *Flowers* many open at the time, moderately opening. *Median sepal* (ob)ovate to elliptic, 2.8–4.5 by 1.8–2.8 mm, index 1.4–1.6, tip acute; rather thin; glabrous. *Lateral sepals* oblique, ovate, 3–4.5 by 2–3.5 mm, index 1–1.6; otherwise as the median sepal. *Petals* oblique, ovate to triangular, 1.3–2.5 by 0.6–1.3 mm, index 1.7–2; tip rounded to acute; otherwise as the median sepal. *Lip* curved, general outline ovate, 1.6–2.3 by 0.8–1.8 mm, index 1.3–2 (not spread), tip rounded; margins either finely papillose towards the base or not; thick; adx. somewhat concave towards the base, with a wide and flat median thickening in the basal half which is not separated from the lateral sides by distinct furrows, surface glabrous or papillose towards the margins in the basal half; abx. with an inconspicuous, truncate median ridge, surface glabrous. *Column* from ovary to the tip of the stelia 0.8–1.6 mm; stigma not protruding at its base, elliptic; column-foot without accessories. *Stelidia* small, triangular, tip acute; often with a small, deltoid, acute tooth along the upper margin. *Anther* abx. with a ridge towards its base; front margin not protruding. *Pollinia* 2.

Colours – Flowers cream or yellow, mottled with purple.

Ecology – Epiphyte in primary temperate humid forest. Alt. not known. Flowering mainly 10.

Distribution – AUSTRALIA. Queensland (SE part); New South Wales (NE part).

Note – Characterized by the peduncle scales with spreading tips, as well as by its many-flowered inflorescences in which the flowers are densely packed. The pineapple-shaped pseudobulbs are so distinct that it is possible to identify the species when sterile (Clements, pers. comm.).

#### 4. *Bulbophyllum elizae* (F. Muell.) Benth. – Fig. 29.

*Bulbophyllum elizae* (F. Muell.) Benth., Fl. Austr. 6 (1873) 289. – *Cirrhopetalum elizae* F. Muell. Fragm. Phyt. Austr. 6 (1868) 120. — Syntypes: Moore s.n. (lecto MEL, designated by Clements 1989); Stuart 714 (1873) (K).

*Rhizome* 1.6–2.5 mm diam. *Pseudobulbs* ovoid, 0.8–1.6 cm apart, 1.5–3.0 by 1–2 cm, not flattened, ribs usually with crenulated edges. *Petiole* 3–10 mm. *Leaf blade* ovate to elliptic, 3–11 by 0.7–1.4 cm, index 4.5–9, tip obtuse to acute. *Inflorescence* 8–25 cm, 5–15-flowered. *Peduncle* 5–14 cm; bracts c. 5, the longest 9–20 mm. *Rachis* erect, 3–11 cm. *Floral bracts* ovate, 1.5–4.5 mm, tip acute. *Pedicel and ovary* 7–14 mm, with the node c. 0.3 mm from the floral bract; ovary glabrous. *Flowers* approx. open at the time, moderately opening. *Median sepal* ovate, 6–8.5 by 2.5–3.6 mm, index 1.7–3.6, tip acute to acuminate; thin; glabrous. *Lateral sepals* oblique, ovate, 12–22 by 2.8–4 mm, index 3–6.6, tip (sub)acute; otherwise as the median sepal. *Petals* ovate, 2.8–3.8 by 1.5–2 mm, index 1.6–2.3, tip obtuse; thin; glabrous. *Lip* curved at the base, general outline ovate to elliptic, 2.8–3.5 by 1.2–1.4 mm, index 2.3–2.7 (not spread), tip obtuse to subacute; thick; approx. glabrous; adx. somewhat concave towards the base, with an inconspicuous median slit, with 2 approx. inconspicuous ridges, as well as a lump towards the tip, abx. with an in-

conspicuous, an approx. truncate median ridge. *Column* from ovary to the tip of the stelia 1.2–2.2 mm; stigma not protruding at its base, elliptic; column-foot without accessories. *Stelidia* short, triangular, tip acute; often with a an inconspicuous, deltoid, obtuse to acute tooth along the upper margin. *Anther* abx. with a ridge towards its base; front margin not protruding. *Pollinia* 4; the inner pair more half as long as the outer pair.

Colours – Pseudobulbs yellowish green. Leaves green. Sepals and petals greenish or yellowish, sometimes suffused with pinkish purple, or entirely dark purple. Lip dark red or purple.

Ecology – Epiphyte in primary humid temperate forest. Sometimes as a lithophyte. Alt. 600–1500 m asl. (Clements, pers. comm.). Flowering 5–11.

Distribution – AUSTRALIA. Queensland (SE part); New South Wales.

Note – Characterized by the lateral sepals, which are much longer than the median one.

## 5. *Bulbophyllum lageniforme* F.M. Bailey – Fig. 30.

*Bulbophyllum lageniforme* F.M. Bailey, Queensl. Agr. J. 15 (1904) 494. — Syntypes: Bellenden Kerr Exp. s.n. (1904) (lecto BRI, designated by Clements, 1989); id. (1889) (not seen).

*Bulbophyllum adenocarpum* Schltr., Fedde, Rep. 8 (1910) 568. — Type: Johnson s.n. (1891) (B, probably destroyed).

*Rhizome* 0.8–1.4 mm diam. *Pseudobulbs* approx. lenticular to ovoid, 0.3–0.8 cm apart, 0.5–1 by 0.5–1 cm, not laterally flattened. *Petiole* 1.8–6 mm. *Leaf blade* elliptic, 1.5–10 by 0.3–0.8 cm, index 3.5–16, tip acute. *Inflorescence* 3–7 cm, 1–2(–4)-flowered. *Peduncle* 2–4 cm; bracts 4, the longest 2.5–3 mm. *Rachis* if present erect, 0.2–1.2 cm. *Floral bracts* ovate, 1.4–2 mm, tip acute. *Pedicel and ovary* 5.5–10 mm, with the node c. 0.3 mm from the floral bract; ovary verrucose. *Flowers* all open at the time, moderately opening. *Median sepal* ovate to elliptic, 6–8.5 by 2.8–4 mm, index 1.7–2.3, tip acute or apiculate, thin; glabrous. *Lateral sepals* oblique, ovate, 5.8–8.5 by 4–6 mm, index 1.2–1.7, tip acute; otherwise as the median sepal. *Petals* oblique, ovate, 4–6.5 by 2.5–2.8 mm, index 1.6–2.3, tip obtuse to acute; thin; glabrous. *Lip* curved at the base, general outline obovate, 5.5–6 by 2.8–3.5 mm, index 1.6–2.2 (not spread), tip rounded; rather thin; glabrous; adx. concave towards the base, with a distinct median slit with thickened margins near the base, with 2 ridges converging in front, abx. with a retuse median ridge. *Column* from ovary to the tip of the stelia 2–3 mm; stigma not protruding at its base, elliptic; column-foot without accessories. *Stelidia* narrowly triangular, 0.4–0.8 mm; tip acute; often with a small, forwards pointing, deltoid to narrowly triangular, acute tooth along the upper margin, with a large, deltoid, obtuse to subacute wing along the lower margin. *Anther* abx. with a ridge towards its base; front margin not protruding. *Pollinia* 4; the inner pair more than half as long as the outer pair.

Colours – Sepals and petals pale green or cream-coloured, with purplish or brownish veins; rarely also entirely pinkish. Lip pale green, sometimes with a purple margin.

Ecology – Epiphyte in primary forest, occasionally as a lithophyte. Alt. 800–1100 m asl. Flowering mainly 1, 11, 12.

Distribution – AUSTRALIA. Queensland, (Atherton and Windsor Tablelands; Clements, pers. comm.).

Note – This species differs from *Bulbophyllum lilianae*, which also has 4 pollinia as well

as a verrucose ovary, by having a distinct basal slit with thickened margins on the adaxial surface of the lip, near the base. Vegetatively it is different in having a shorter rhizome, with the pseudobulbs more closely packed.

## 6. *Bulbophyllum lilianae* Rendle – Fig. 31.

*Bulbophyllum lilianae* Rendle, J. Bot. London 55 (1917) 308. — Type: Gibbs 6304 (BM).

*Bulbophyllum revolutum* Dockrill & St. Cloud, Victorian Nat. 74 (1957) 67. — Type: Dyson-Holland s.n. (1955) (NSW, not seen).

*Rhizome* 0.9–1.6 mm diam. *Pseudobulbs* ovoid, 0.9–3 cm apart, 0.5–1.2 by 0.2–0.6 cm, not flattened. *Petiole* 0.5–3 mm. *Leaf blade* elliptic, 1–3.4 by 0.3–1 cm, index 1.7–6, tip obtuse to acute. *Inflorescence* 1.8–4.5 cm, 1–2-flowered. *Peduncle* 0.8–3.2 cm; bracts 3–5, the longest 1.8–4 mm. *Rachis* if present erect, 0.2–0.4 cm. *Floral bracts* ovate, 1.3–2.5 mm, tip acute to acuminate. *Pedicel and ovary* 4.5–8 mm, with the node c. 0.5 mm from the floral bract; ovary verrucose. *Flowers* all open at the time, moderately opening. *Median sepal* ovate to elliptic, 4–7 by 2–3.5 mm, index 2–2.8, tip acute; thin; approx. glabrous. *Lateral sepals* oblique, ovate, 4–7.5 by 2.8–4 mm, index 1.6–2.3, otherwise as the median sepal. *Petals* oblique, (ob)ovate to elliptic, 3.2–5 by 1.2–2 mm, index 1.7–3.3, tip obtuse to acute; thin; glabrous. *Lip* curved at the base, general outline ovate, 2.8–3.9 by 1–1.8 mm, index 2.1–3.2 (not spread), tip rounded; thick; approx. glabrous; adx. concave towards the base, abx. without with an inconspicuous, retuse median ridge. *Column* from ovary to the tip of the stelia 1.3–2 mm; stigma not protruding at its base, elliptic; column-foot without accessories. *Stelidia* small, triangular, tip rounded to acute; usually with an inconspicuous to distinct, deltoid, obtuse to acute tooth along the upper margin, with a large, deltoid, obtuse to acute wing along the lower margin. *Anther* abx. with a ridge towards its base; front margin somewhat protruding. *Pollinia* 4; the inner pair more than half as long as the outer pair.

*Colours* – Sepals and petals yellowish green to yellowish brown, or reddish, usually with purple veins. Lip suffused with brown or purple.

*Ecology* – Epiphyte in primary forest, occasionally as a lithophyte. Alt. 900–1800 m asl. Flowering mainly 7–9.

*Distribution* – AUSTRALIA. Queensland, (Atherton Tableland to Townsville; Clements, pers. comm.).

*Note* – Rather similar to *Bulbophyllum lageniforme*; see the note under that species.

## 7. *Bulbophyllum lingulatum* Rendle – Fig. 32.

*Bulbophyllum lingulatum* Rendle, J. Linn. Soc. 45 (1921) 247. — Type: Compton 1818 (BM).

*Bulbophyllum microphyton* Guillaumin, Mém. Mus. Hist. Nat. Paris, Bot. 8 (1957) 41. – *B. lingulatum* f. *microphyton* Hallé, Fl. Nouv.-Caléd. et Dépend. 8 (1977) 178. — Type: Hürlimann 1356 (P).

*Rhizome* 1–1.2 mm diam. *Pseudobulbs* ovoid, 0.5–1.5 cm apart, 0.4–0.7 by 0.15–0.4 cm, not flattened. *Petiole* 0.5–1 mm. *Leaf blade* elliptic, 0.6–3.5 by 0.3–0.6 cm, index 2–5, tip acute. *Inflorescence* 0.9–3 cm, 1–2-flowered. *Peduncle* 0.4–2 cm; bracts 3, the longest 1.4–2 mm. *Rachis* if present erect, c. 0.3 cm. *Floral bracts* ovate, 1.2–1.5 mm, tip acute. *Pedicel and ovary* 4–8 mm, with the node c. 1 mm from the floral bract; ovary glabrous. *Flowers* all open at the time, moderately opening. *Median sepal* ovate-

elliptic, 5–8 by 2–3 mm, index 2–2.5, tip shortly acuminate; thin; glabrous. *Lateral sepals* oblique, ovate, c. 5.5–8 by 3–3.8 mm, index 1.5–2.2, otherwise as the median sepal. *Petals* oblique, ovate to elliptic, 3–4 by 1.2–1.5 mm, index 2.4–3, tip approx. acute; thin; glabrous. *Lip* curved, general outline elliptic, 2.8–3 by 0.9–1.5 mm, index 2–3 (not spread), tip rounded; margins with a recurved (towards the abaxial side of the lip), forwards pointing, triangular, obtuse tooth at approx. 1/3 of the length of the lip; thick; glabrous; adx. concave towards the base, with 2 ridges converging in front; abx. with an inconspicuous, truncate median ridge. *Column* from ovary to the tip of the stelia 1.4–1.8 mm; stigma not protruding at its base, orbicular; column-foot approx. without accessories. *Stelidia* triangular, c. 0.3 mm, tip approx. acute; with a distinct, forwards pointing, (narrowly) triangular, acute tooth along the lower margin. *Anther* abx. with a ridge towards its base; front margin not protruding. *Pollinia* 4; the inner pair more than half as long as the outer pair.

Colours – Sepals and petals white, pinkish or pale yellow. Lip white or yellow.

Ecology – Epiphyte in primary forest and shrub vegetation. Alt. 600–1400 m asl. Flowering observed in 3, 4, 7, 9, 10, 12.

Distribution – NEW CALEDONIA.

Note – Differs from *Bulbophyllum newportii* by the inflorescence with fewer flowers, by the teeth along the margin of the lip which are recurved and point towards the abaxial side of the lip, as well as by the glabrous adaxial surface of the lip.

## 8. *Bulbophyllum newportii* (F.M. Bailey) Rolfe – Fig. 33.

*Bulbophyllum newportii* (F.M. Bailey) Rolfe, Orch. Rev. 17 (1909) 94. – *Sarcochilus newportii*

F.M. Bailey, Queensl. Fl. 6 (1902) 2014. — Type: Newport 20 (holo BRI; iso K)

*Bulbophyllum exiguum* F. Muell. var. *dallachyi* Benth., Fl. Austr. 6 (1873) 289. — Type: Dallachy s.n. (MEL).

*Bulbophyllum trilobum* Schltr., Fedde, Rep. 8 (1910) 455. — Type: Bauer (1884) (B, probably destroyed).

*Bulbophyllum wilkianum* Hunt, North Queensl. Nat. 14 (1947) 17. — Type: Wilkie s.n. (9/1946) (BRI).

*Bulbophyllum wanjurum* Hunt, North Queensl. Nat. 14 (1947) 18. — Type: Wilkie in Hunt 546 (BRI).

*Rhizome* 1–2 mm diam. *Pseudobulbs* ovoid, 0.5–2.2 cm apart, 0.5–1.4 by 0.4–1 cm, not flattened. *Petiole* 0.5–7 mm. *Leaf blade* ovate to elliptic, 1.1–7 by 0.4–1 cm, index 2.8–8, tip acute. *Inflorescence* 2.2–9 cm, 2–8-flowered. *Peduncle* 1.7–5 cm; bracts 3–4, the longest 3–5 mm. *Rachis* approx. erect, 0.5–4 cm. *Floral bracts* ovate, 1.5–3 mm, tip acute. *Pedicel and ovary* 5–8 mm, with the node 0.8–1 mm from the floral bract; ovary approx. glabrous. *Flowers* all open at the time, little opening. *Median sepal* elliptic, 5–7 by 2–3 mm, index 2–2.5, tip emarginate to obtuse; margins often slightly papillose; thin; surface glabrous. *Lateral sepals* oblique, ovate, 5–6 by 2.5–4 mm, index 1.6–2.2, tip approx. acute; otherwise as the median sepal. *Petals* oblique, elliptic to obovate, 3.5–4.5 by 1.4–2.2 mm, index 1.8–3.3, tip rounded; margins often slightly papillose; thin; surface glabrous. *Lip* curved, general outline approx. ovate, 3–4.5 by 1.3–1.9 mm, index 2–3.5 (not spread), tip rounded; margins approx. glabrous except for a papillose-ciliate portion in front of an erect, forwards pointing, narrowly triangular, acute tooth, which is usually present along each margin at approx. 1/3 of the length of the lip; thick; adx. concave towards the base, with 2 inconspicuous ridges converging in front, surface papillose towards the base; abx. with a distinct, truncate median ridge, surface glabrous. *Column* from ovary to the tip of the stelia 1.5–2.5 mm; stigma not protruding at its base, transversely elliptic; column-foot without accessories. *Stelidia* triangular, 0.8–1.2 mm, tip acute; with



a distinct, forwards pointing, narrowly triangular, acute tooth along the lower margin. *Anther* abx. with a ridge towards its base; front margin not protruding. *Pollinia* 4; the inner pair more than half as long as the outer pair.

Colours – Flowers white, pale yellowish, pale greenish, or pale pink, occasionally with purple veins and spots.

Ecology – Epiphyte in primary humid forest. Also as a lithophyte in drier and more open forest. Alt. 600–1300 m asl. Flowering mainly 9–12.

Distribution – AUSTRALIA. Queensland.

Notes – 1. Rather similar to *Bulbophyllum lingulatum*. The differences are mentioned under the latter species.

2. The illustrated specimen has slightly wider sepals and petals than the other specimens studied.

3. The type specimen of *Bulbophyllum wilkianum* lacks the lateral lobes on the lip, but is otherwise not different.

4. Clements (1989) maintains *Bulbophyllum wilkianum* (syn.: *B. exiguum* var. *dallachyi* and *B. wanjurum*) as a species next to *B. newportii* (syn.: *B. trilobum*). According to him, *B. newportii* differs in the “acute rather than obovate” sepals, as well as in the “narrower and more acute” lip. It should also have “pink” flowers with a “yellow” lip, whereas *B. wilkianum* has “cream coloured flowers, occasionally with pink flushes”, and a “dark cream to light yellow lip” (all citations Clements, pers. comm.). Finally, *B. newportii* should have the pseudobulbs placed closer together (Clements, 1989). However, a careful analysis of the flowers of the type specimens of all the names mentioned reveals that they are almost identical in all details (the missing lateral lobes of the lip in *B. wilkianum* excepted). The differences in flower colour are minor. The distance between the pseudobulbs is 17, respectively 15 mm in the BRI and K sets of the type of *B. newportii*, and 14–19 mm in the MEL isotype of *B. exiguum* var. *dallachyi*. The types of *B. wanjurum* and *B. wilkianum* do not permit observing this character because they consist of an inflorescence only. The sketches accompanying the original descriptions, however, do not suggest anything aberrant. In my opinion, *B. wilkianum* cannot be upheld as a separate taxon of any rank.

### Section Lepanthanthe

*Bulbophyllum* sect. *Lepanthanthe* Schltr., Fedde, Rep. Beih. 1 (1913) 704 & 875. — Type species: *Bulbophyllum lepanthiflorum* Schltr.

*Bulbophyllum* sect. *Trachyrhachis* Schltr., Fedde, Rep. Beih. 1 (1913) 704 & 877. — Lectotype species: *Bulbophyllum barbilabium* Schltr. (= *B. bulliferum* J.J. Smith).

*Bulbophyllum* subg. *Antennisepalum* Schltr., Fedde, Rep. Beih. 1 (1913) 704; P. Royen, Alpine Fl. New Guinea 2 (1979) 188. — Lectotype species: *Bulbophyllum antennatum* Schltr. (design. P. Royen).

*Rhizome* creeping (Series B, C) or pendulous (Series A); rhizome scales shorter or longer than the internodes they cover. *Roots* sprouting below the pseudobulbs only; or below the older pseudobulbs only in case the rhizome is pendulous. *Inflorescence* with 2 flowers or more. *Median sepal*: tip a fleshy, subulate projection, often ending in a thickened knob. *Petals* distinct, not very small. *Lip* either with basal (front margin of the lobe inserted into the adx. surface of the lip) or with lateral (front margin inserted into the margin of the lip) lobes, rarely undivided (*quasimodo*, *thersites*); lip above the ligament with-

out a concavity with two teeth in front. *Column*: rostellum somewhat protruding in lateral view or not; base of the stigma protruding in lateral view or not, without or with 1 tooth (*thersites*); column-foot either without accessories, or with small lateral wings, or with a sometimes very distinct, thin central tooth. *Stelidia* absent or present, without a tooth along their lower margins, or with a forwards or downwards directed, straight or falcate, deltoid to narrowly triangular, rounded to acute tooth along their lower margin (or, in case the stelidia are absent: the lateral margins of the stigma without a tooth, or with a tooth as described above). *Pollinia* 2. *Stipes* absent.

Notes – 1. Section *Lepanthanthe* is characterized by the following polythetic set: Sepals with subulate projections at their tip; lip with lobes near its base.

2. Schlechter's sections *Lepanthanthe* and *Trachyrhachis* share a number of characters in the flowers which are unique in *Bulbophyllum*. The two sections are fused here, ignoring the differences in the growth habit and the inflorescence.

#### KEY TO THE SPECIES OF SECTION LEPANTHANTHE

- 1a. Rhizome pendulous, attached to the substratum only at its base. Roots growing along the rhizome towards the point of attachment, only spreading after reaching it (Series A) 2
- b. Rhizome creeping over the substratum. Roots growing away from the rhizome, entering the substratum . . . . . 5
- 2a. Petals divided in a distinct, narrow claw of 0.6–1.3 mm long, and a wide blade. Margins of petals entire . . . . . 3
- b. Petals narrowed towards the base but not clawed; or petals with an inconspicuous claw of at most 0.2 mm long. Margins of petals finely denticulate . . . . . 4
- 3a. Lip adx. with a triangular concavity reaching over half-way of the lip. Basal lobes of the lip with the frontal margin inserted along the margin of the lip . . 9. **B. cruttwellii**
- b. Lip adx. with a narrow, slit-like concavity reaching over half-way of the lip. Basal lobes of the lip with the frontal margins converging over the adaxial surface of the lip  
10. **B. inquirendum**
- 4a. (2) Index leaves in a flowering part of the plant 1.3–2 . . 11. **B. lepanthiflorum**
- b. Index leaves in a flowering part of the plant 5–9 . . . . . 12. **B. leptophyllum**
- 5a. (1) Margins of petals distinctly ciliate (Series B) . . . . . 6
- b. Margins of petals glabrous, papillose, erose or denticulate; without cilia (Series C) 9
- 6a. Petals triangular, broadly inserted, index 10–15 . . . . . 13. **B. antennatum**
- b. Petals ovate, elliptic, orbicular, obovate or cordate, narrowly inserted or clawed, index 0.8–2 . . . . . 7
- 7a. Column-foot with a distinct, upwards pointing central tooth . . . . 16. **B. toranum**
- b. Column-foot without a central tooth, or with a very inconspicuous one . . . . . 8
- 8a. Lateral sepals 4–4.5 mm long. Tips of the basal lobes of the lip backwards directed when viewing the lip from aside . . . . . 15. **B. nephropetalum**
- b. Lateral sepals 1.5–3 mm long. Tips of the basal lobes of the lip forwards directed when viewing the lip from aside . . . . . 14. **B. erinaceum**

- 9a. (5) Margins of median sepal distinctly ciliate . . . . . **18. B. bulliferum**  
 b. Margins of median sepal glabrous, slightly erose or slightly papillose, but without cilia. . . . . 10
- 10a. Lip entirely without lobes near its base . . . . . 11  
 b. Lip with distinct lobes near its base . . . . . 12
- 11a. Lip adaxially without a median thickening close to its base, just above the ligament. Stigma protruding at its base, but without a tooth . . . . . **20. B. quasimodo**  
 b. Lip adaxially with a median thickening close to its base, just above the ligament. Stigma with a distinct, protruding tooth at its base . . . . . **21. B. thersites**
- 12a. (10) Lower margins of the column each with a distinct, straight, subulate, acute tooth of c. 1.3 mm long. Frontal margin of the lobes at the base of the lip, and sometimes the margins of the lip itself, distinctly ciliate . . . . . **22. B. trachypus**  
 b. Lower margins of the column without teeth, or each with an inconspicuous tooth of at most 0.2 mm long. Margins of the lip, the lobes near its base included, glabrous, or finely or coarsely papillose, but without cilia . . . . . 13
- 13a. Rachis erect or arching. Median lobe of the lip finely and inconspicuously papillose. Basal lobes of the lip with the frontal margin inserted along the margin of the lip  
**17. B. baculiferum**  
 b. Rachis nodding at its base. Median lobe of the lip distinctly and coarsely papillose near the margins. Basal lobes of the lip with the frontal margins converging over the adaxial surface of the lip . . . . . **19. B. parabates**

**Series A**  
 Rhizome hanging.

**9. Bulbophyllum cruttwellii** J.J. Vermeulen, *spec. nov.* – Fig. 34; Plate 1a.

*Bulbophyllum cruttwellii* a *B. inquirendo* a trans labelli laterem adaxialem sulco mediali late triangulari differt. — Typus: Jongejan 1325 (L).

*Rhizome* pendulous, up to 100 cm long, 0.8–2 mm diam. (seemingly thicker because of loosely imbricate scales). *Roots* creeping over the rhizome. *Pseudobulbs* cylindrical, 2–4.5 cm apart, 0.4–0.5 by 0.1–0.2 cm, hardly flattened. *Petiole* 3–7 mm. *Leaf blade* triangular to elliptic, 3–6.5 by 2.5–5 cm, index 1–2, base often cordate, tip acute to acuminate. *Inflorescences* up to 4 together on a short sympodium, pendulous, 0.8–3 cm, up to 80-flowered. *Peduncle* 0.5–1.3 cm; bracts c. 6, the longest 5.5–7 mm. *Rachis* up to 1.7 cm. *Floral bracts* ovate, 6–7 mm, tip acuminate. *Pedicel and ovary* 6–9 mm, with the node 4–8.5 mm from the floral bract. *Flowers* scattered, 1 open at the time, widely opening. *Median sepal* orbicular to elliptic, 2.5–3 by 2–2.8 mm, index 1–1.3, tip an incurved, subulate projection 1.2–2 mm long; glabrous; thin. *Lateral sepals* oblique, orbicular to transversely elliptic, 2.2–2.8 by 2.5–3.2 mm, index 0.7–1, otherwise as the median sepal. *Petals* with a narrow claw 0.6–1 mm long; blade obliquely elliptic, 1.5–2 by 0.5–0.8 mm, index 2.5–3, tip rounded to obtuse; margins glabrous or finely papillose; very thin; surface glabrous. *Lip* 3-lobed, median lobe curved at the base, ovate to elliptic, 1–1.5

by 0.6–0.8 mm, index 1.6–2 (not spread), tip obtuse; margins glabrous or very finely papillose; thick; surface approx. glabrous; adx. concave and with 3 parallel, short ridges near the base, which in front abruptly end into a triangular concavity bordered by 2 more ridges which in front converge; abx. approx. without a median ridge; basal lobes with the frontal margin inserted along the margin of the lip; triangular to obovate, tip rounded to obtuse, margins finely papillose; thin; surface glabrous. *Column* from ovary to the tip of the stelia 1–1.2 mm; stigma hardly protruding at its base, elliptic to orbicular; column-foot without accessories. *Stelidia* triangular, 0.3 mm, tip obtuse to acute; with or without a distinct, forwards projecting, triangular, obtuse tooth along the lower margin. *Anther* abx. with a ridge towards its base; front margin not protruding.

Colours – Rhizome scales pale yellowish brown when dry. Sepals pale yellow, petals white, lip yellowish, or purple, often with white basal lobes.

Ecology – Epiphyte in primary forest. Alt. 1800–3300 m asl. Flowering 3, 6–12.

Distribution – INDONESIA & PAPUA NEW GUINEA. New Guinea (central mountain range from Jayawijaya Ra. to Owen Stanley Ra. Also Saruwaged Mts).

Notes – 1. Differs from *Bulbophyllum lepanthiflorum* in having distinctly clawed petals and a lip without large vesicles. Vegetatively it differs in having glabrous, not papillose, rhizome scales which, when dry, are pale ochre instead of dark red. The differences from *B. inquirendum* are given under the latter species.

2. *Bulbophyllum cruttwellii* is somewhat variable in the floral parts. The basal lobes on the lip are often larger than in the illustrated specimen. Some specimens (e.g. Hiepko & Schultze-Motel 1333) have a distinct tooth along the lower margin of the stelia.

3. Incidentally aberrant specimens have been found: e.g. Carr 10518, which lacks the subulate projections on the sepals, or Vink 17547, which has one flower with entirely filiform petals (next to a number of flowers with normal petals).

4. The species has been named after the Revd. Canon Norman Cruttwell, an enthusiastic student of the orchid flora of New Guinea.

## 10. *Bulbophyllum inquirendum* J.J. Vermeulen, *spec. nov.* – Fig. 35.

*Bulbophyllum inquirendum* a *B. cruttwellii* a trans labelli laterem sulco mediali anguste, a *B. lepanthiflorum* petalis petiolatis differt. — Typus: Reeve 6641 (K).

*Rhizome* pendulous, up to 50 cm long, 0.8–2 mm diam. (seemingly thicker because of loosely imbricate, finely papillose scales). *Roots* creeping over the rhizome. *Pseudobulbs* cylindrical, 2–4.5 cm apart, c. 0.5 by 0.1–0.2 cm, hardly flattened. *Petiole* 3–8 mm. *Leaf blade* triangular to ovate, 2.7–4.2 by 1.8–3.7 cm, index 1.1–1.6, base often cordate, tip acute to acuminate. *Inflorescences* up to 3 together on a short sympodium, pendulous, 1–1.8 cm, up to 10-flowered. *Peduncle* 0.4–1.1 cm; bracts 4–5, the longest 3–4.5 mm. *Rachis* up to 0.4 cm. *Floral bracts* ovate, c. 4 mm, tip acuminate. *Pedicel and ovary* 5–11 mm, with the node 3–5.5 mm from the floral bract. *Flowers* scattered, 1 open at the time, widely opening. *Median sepal* orbicular to elliptic, 2.4–3.2 by 2–3.2 mm, index 1–1.2, tip an incurved, subulate projection 1–1.8 mm long; margins slightly papillose; thin; surface glabrous. *Lateral sepals* oblique, orbicular to transversely elliptic, 2.2–3.1 by 2–3.8 mm, index 0.8–1, otherwise as the median sepal. *Petals* with a narrow claw 1–1.3 mm long; blade ovate to elliptic, 1.5–2.2 by 0.8–1.8 mm, index 1.2–1.8, tip emarginate to obtuse;

margins finely papillose; very thin; surface glabrous. *Lip* 3-lobed, median lobe curved at the base, ovate to elliptic, 1.1–1.3 by 0.7–0.8 mm, index 1.6–2 (not spread), tip obtuse; margins as well as abaxial surface either finely papillose only, or densely set with large, elongated vesicles of various size which gradually become smaller towards the centre of the abaxial side; thick; adx. concave and with a very short and inconspicuous median ridge close to the base, the concavity continuing as a narrow median slit reaching over half-way of the lip, bordered by 2 more ridges which in front are fused along their crests and in the back protrude as lobes, surface finely papillose; abx. with 2 inconspicuous, rounded ridges near the base, concave towards the tip; basal lobes with the frontal margins converging over the adaxial surface of the lip; falcate, narrowly triangular, tip approx. obtuse; margins slightly erose; thin; surface glabrous. *Column* from ovary to the tip of the stelia c. 0.8 mm; stigma somewhat protruding at its base, orbicular; column-foot without accessories. *Stelidia* inconspicuous, tip rounded; margins erose; with a falcate, approx. forwards projecting, narrowly triangular, acute tooth along the lower margin. *Anther* (not seen).

Colours – Rhizome scales dull greyish brown when dry. Leaves red. Sepals and petals creamy white. Lip purplish.

Ecology – Epiphyte in primary forest. Alt. 1800–2200 m asl. Flowering observed in 7, 9.

Distribution – INDONESIA & PAPUA NEW GUINEA. New Guinea (central mountain range: Sudirman Ra.; Western Highlands Prov.).

Notes – 1. This species is morphologically more or less intermediate between *Bulbophyllum cruttwellii* and *B. lepanthiflorum*. Compared to these species, it does not show unique features, yet it is easily to define by the following set of characters: distinctly clawed petals (as in *cruttwellii*), as well as lobes on the lip which in front are converging over the adaxial surface of the lip (as in *lepanthiflorum*). A median slit on the adaxial side of the lip, as occurs in *B. inquirendum*, has also been found in a single specimen of *B. lepanthiflorum* (see note 2 under the latter species).

2. The two specimens available to the author are similar in most aspects but differ in the shape of the lip: one has an elliptic lip with large vesicles on its top part whereas the other has an ovate lip which is only slightly papillose all over.

3. The observations in note 1 and 2 make *Bulbophyllum inquirendum* a dubious entity. It may be a species showing excessive variability in the shape of the lip, but it is also possible that it is of hybrid origin, with *B. cruttwellii* and *B. lepanthiflorum* as parents. More information is needed here, hence the name chosen for this species.

## 11. *Bulbophyllum lepanthiflorum* Schltr. – Fig. 36; Plate 1b.

*Bulbophyllum lepanthiflorum* Schltr., Fedde, Rep. Beih. 1 (1913) 876; 21 (1928) f. 1176. — Syntypes: Schlechter 16607 & 19190 (B, †). Neotype: Brass 7137 (AMES, L).

*Bulbophyllum lepanthiflorum* Schltr. var. *rivulare* Schltr., Fedde, Rep. Beih. 1 (1913) 876. — Syntypes: Schlechter 19421 (B, †), 19562 (B, †; iso BM, K).

*Rhizome* pendulous, up to 100 cm long, 1.2–1.8 mm diam. (seemingly thicker with loosely imbricate, finely papillose scales). *Roots* creeping over the rhizome. *Pseudobulbs* cylindrical to ellipsoid, 1.2–2.5 cm apart, 0.3–0.6 by 0.2–0.4 cm, hardly flattened. *Petiole* 2–4 mm. *Leaf blade* ovate to elliptic, 3–6 by c. 0.2 cm, index 1.3–2, tip acute to acuminate. *Inflorescences* often many together on a sympodium, pendulous, 1.2–2.5 cm, up to 15-flowered. *Peduncle* 0.8–1.2 cm; bracts c. 4, the longest 4–8 mm. *Rachis* 0.4–0.6

cm. *Floral bracts* triangular, 3–3.5 mm, tip acuminate. *Pedicel and ovary* c. 6 mm, with the node 1–3 mm from the floral bract. *Flowers* scattered, 1 or a few open at the time, widely opening. *Median sepal* elliptic to obovate, 2.5–4 by 2–2.8 mm, index 1.2–1.4, tip an incurved, subulate projection c. 1 mm long; glabrous; thin; abx. sometimes with an inconspicuous, somewhat erose median keel. *Lateral sepals* oblique, approx. orbicular, 2–2.8 by 1.8–2.8 mm, index 1–1.2, tip an incurved, subulate projection c. 1.2 mm long; otherwise as the median sepal. *Petals* often with a claw up to 0.2 mm long; blade obliquely elliptic, 0.8–2 by 0.6–1.4 mm, index 1.2–1.5, tip retuse to rounded; margins denticulate; very thin; surface glabrous. *Lip* 3-lobed, median lobe straight, general outline elliptic, c. 1 by 0.6 mm, index c. 1.6 (not spread), tip rounded; margins as well as abaxial surface densely set with large, elongated vesicles which gradually change into small papillae towards the centre of the abaxial side; thick; adx. concave and with 3 parallel, short ridges near the base, which in front are clasped between 2 more ridges which in front converge and in the back protrude as lobes, surface finely papillose towards the margins; abx. without a median ridge; basal lobes with the frontal margins converging over the adaxial surface of the lip; falcate, narrowly triangular, tip obtuse; glabrous; thin. *Column* from ovary to the tip of the stelidia 0.5–0.7 mm; stigma hardly protruding at its base, elliptic; column-foot without accessories. *Stelidia* triangular, c. 0.2 mm; tip acute; with a distinct, forwards projecting, approx. narrowly triangular, obtuse tooth along the lower margin. *Anther* abx. with a ridge towards its base; front margin not protruding.

Colours – Rhizome scales dark reddish brown when dry. Sepals and petals pale yellow. Lip red purple, with or without a white tip and basal lobes. Flowers also entirely white.

Ecology – Epiphyte in primary forest. Alt. 200–700 m asl. Flowering observed in 1–3, 5, 6, 10.

Distribution – INDONESIA & PAPUA NEW GUINEA. New Guinea (central mountain range from Sudirman Ra. to Owen Stanley Ra. Also Finisterre Mts); Yapen Isl.

Notes – 1. The differences from *Bulbophyllum cruttwellii* as well as *B. inquirendum* are given under these respective species.

2. The specimen Leiden cult. 31698 has a median slit on the adaxial side of the lip, just as *Bulbophyllum inquirendum*. Otherwise this specimen is not different from *B. lepanthiflorum*.

3. Some variability occurs in the index of the petals.

## 12. *Bulbophyllum leptophyllum* Kitteridge – Fig. 37.

*Bulbophyllum leptophyllum* Kitteridge, Bot. Mus. Leaflet. Harv. Un. 30 (1984) 99. – *Bulbophyllum lonchophyllum* Schltr., Fedde, Rep. 16 (1919) 123; J.J. Smith, Nova Guinea 14, 3 (1929) 472. — Type: Kempf s.n. (B, †). Neotype: Lam 1493 (holo L, iso BO).

Non *Bulbophyllum lonchophyllum* Schltr., Fedde, Rep. Beih. 1 (1913) 790; 21 (1928) f. 1016.

*Rhizome* pendulous, up to 40 cm long, c. 0.7 mm diam. (seemingly thicker with loosely imbricate, finely papillose scales). *Roots* creeping over the rhizome. *Pseudobulbs* cylindrical, 1–2 cm apart, c. 0.3 by 0.1 cm, hardly flattened. *Petiole* 1–2 mm. *Leaf blade* ovate to elliptic, 3–6 by 0.4–1.1 cm, index 5–9, tip acute. *Inflorescences* up to 4 together on a short sympodium, pendulous, 1.2–1.3 cm, up to 6-flowered. *Peduncle* c. 0.5 cm; bracts 3–4, the longest 3–4 mm. *Rachis* up to 0.7 cm. *Floral bracts* elliptic, 3.5–4.5 mm, tip acute to acuminate. *Pedicel and ovary* 6–7 mm, with the node c. 3 mm from the floral

bract. *Flowers* scattered, 1 open at the time, moderately opening. *Median sepal* approx. orbicular, c. 1.9 by 1.8 mm, index c. 1, tip a straight, subulate projection c. 0.7 mm long; margins finely papillose; thin; surface glabrous, abx. with a somewhat erose median keel. *Lateral sepals* oblique, ovate, c. 2 by 1.7 mm, index c. 1.2; otherwise as the median sepal. *Petals* with a claw up to 0.2 mm long; blade elliptic or slightly obovate, c. 1 by 0.5 mm, index c. 2, tip retuse, margins denticulate and finely papillose; very thin; surface glabrous. *Lip* 3-lobed, median lobe straight, general outline ovate, slightly narrowed towards the tip, c. 1.8 by 1 mm, index c. 1.8 (not spread), tip rounded; margins finely papillose towards the base; thick; adx. near the base with a short median ridge in a small concavity bordered by 2 large lobes, surface glabrous, finely papillose towards the margins near the base; abx. with two distinct rounded ridges, surface finely papillose; basal lobes with the frontal margins converging over the adaxial surface of the lip; falcate, approx. triangular, tip obtuse; finely papillose; thin. *Column* from ovary to the tip of the stelidia c. 1 mm; stigma somewhat protruding at its base, orbicular; column-foot without accessories. *Stelidia* inconspicuous, tip rounded; margins erose; with an approx. forwards projecting, deltoid, acute tooth along the lower margin. *Anther* abx. with a ridge towards its base; front margin not protruding.

Colours – Rhizome scales brown. Leaves strongly suffused with red. Flowers yellowish white.

Ecology – Epiphyte in primary forest. Alt. c. 1400 m asl. Flowering observed in 10.

Distribution – INDONESIA & PAPUA NEW GUINEA. New Guinea (central mountain range: Sudirman Ra.; Wharton Ra.).

Note – Among the species of sect. *Lepanthanthe* with a hanging rhizome it is well characterized by the narrow leaves. The flowers are rather similar to those of *B. lepanthiflorum*, but the median lobe of the lip is of different outline, and less conspicuously papillose.

### Series B

Rhizome creeping. Margins of petals partly or entirely ciliate.

#### 13. *Bulbophyllum antennatum* Schltr. – Fig. 38; Plate 1c.

*Bulbophyllum antennatum* Schltr. in Schum. & Laut., Nachtr. (1905) 196; Fedde, Rep. Beih. 1 (1913) 877; 21 (1928) f. 1178. — Type: Schlechter 14042 (B, †). Neotype: Jongejan 1228 (L).

*Bulbophyllum navigioliferum* J.J. Smith, Nova Guinea 14, 3 (1929) 472. — Type: Lam 1900 (holo BO; iso L).

*Rhizome* creeping, 1.5–6 mm diam. *Roots* spreading. *Pseudobulbs* discoid to ovoid, 0.8–6 cm apart, 0.15–0.6 by 0.2–0.4 cm, not laterally flattened. *Petiole* 7–25 mm. *Leaf blade* elliptic to obovate, 3.8–9 by 0.7–3.5 cm, index 1.8–6, tip rounded. *Inflorescence* usually single, 12–60 cm, up to c. 100-flowered. *Peduncle* 11.5–35 cm, sometimes verrucose towards the tip; bracts 4–5, the longest 4–7 mm. *Rachis* erect, arching or nodding, up to 13 cm, verrucose or not. *Floral bracts* (slightly) cymbiform, elliptic to obovate, 4.5–10 mm, tip acute to acuminate; margins finely papillose; abx. with a distinct, sometimes erose median keel. *Pedicel and ovary* 10–12 mm, with the node 4–5 mm from the floral bract. *Flowers* in 3 rows, 1 open at the time, moderately opening. *Median sepal* elliptic to obovate, 6–10 by 2.2–3.2 mm, index 2.6–3.5, tip an incurved to recurved, subulate

projection c. 1 mm long, ending in a thickened, sometimes papillose knob; margins ciliate; thin; surface glabrous. *Lateral sepals* obliquely obovate, 3.5–5 by 2.5–3 mm, index 1.6–2, tip an incurved, subulate projection; upper margin finely erose, lower ciliate; otherwise as the median sepal. *Petals* triangular, 2–3.2 by 0.2–0.3 mm, index 10–15, tip acute; thin; margins and surface ciliate towards the tip. *Lip* 3-lobed, median lobe approx. straight, general outline spatulate, 4–5.5 by 1–1.8 mm, index 2.8–5.5 (not spread), tip rounded to emarginate; margins glabrous; thick, thin towards the margins; adx. somewhat concave and with a thin median ridge near the base, which continues into a median slit bordered by 2 more ridges which in front converge (and, half-way the lip, are fused along their crests, thus overtopping the median ridge) and in the back protrude as lobes, surface glabrous; abx. without a median ridge, surface glabrous with a tuft of distinct, elongated vesicles near the base; basal lobes with the frontal margins converging over the adaxial surface of the lip; triangular, tip obtuse to acute; glabrous; thin. *Column* from ovary to the tip of the steldia 0.5–0.7 mm; stigma protruding at its base (sometimes with a downwards directed tooth), obovate; column-foot with a distinct, subacute central tooth close to the attachment of the lip. *Steldia* inconspicuous, triangular, tip rounded to acute; upper margin erose or not; with a distinct, forwards projecting, triangular, subacute tooth along the lower margin. *Anther* abx. with a ridge towards its base; front margin not protruding.

Colours – Floral bracts greenish orange to red. Flowers greenish or white, suffused brown-red to purple, or entirely of that colour. Tip of the sepals sometimes blackish.

Ecology – Epiphyte in (open) primary forest; sometimes in secondary vegetation. Alt. 1500–2800 m asl. Flowering observed in 1, 3, 7–9, 12.

Distribution – INDONESIA & PAPUA NEW GUINEA. New Guinea (central mountain range from Sudirman Ra. to Milne Bay Prov. Also Finisterre Mts).

Notes – 1. This species is well characterized by the shape of the petals and of the lip.

2. Variability mainly occurs in the size of the vegetative parts as well as the floral bracts.

3. *Bulbophyllum navigioliferum* is based on a specimen with a single, very young flower bud only, dissected by J.J. Smith. The shape of the flower parts does not differ significantly from flower buds in a similar stage of development of specimens which certainly belong to *B. antennisepalum*. Only the petals are distinctly wider and elliptic, according to J.J. Smith's drawing. Unfortunately both petals are missing from the specimen, so that this cannot be checked. It is assumed that *B. navigioliferum* is conspecific with *B. antennatum*.

#### 14. *Bulbophyllum erinaceum* Schltr. – Fig. 39; Plate 1d.

*Bulbophyllum erinaceum* Schltr., Fedde, Rep. Beih. 1 (1913) 879; 21 (1928) f. 1181. — Type: Schlechter 20235 (holo B, †; iso AMES, BO, L).

*Rhizome* creeping, 0.7–1.5 mm diam. *Roots* spreading. *Pseudobulbs* discoid to ovoid, 0.1–1.5 cm apart, 0.1–0.4 by 0.1–0.25 cm, not laterally flattened. *Petiole* 2–5 mm. *Leaf blade* elliptic, 1.5–5 by 0.3–0.8 cm, index 1.5–10, tip acute. *Inflorescence* usually single, 4.5–32 cm, 7–25-flowered. *Peduncle* 1.5–21 cm, verrucose; bracts 2–3, the longest 1–4 mm. *Rachis* erect or arching, sometimes distinctly zigzag bent, 3–11 cm, verrucose. *Floral bracts* triangular, 1.8–4 mm, tip acuminate, abx. with a distinct, deeply lacerate median keel or not. *Pedicel and ovary* 3–5 mm, with the node 1.5–2 mm from the floral bract; surface verrucose or not. *Flowers* scattered, 1 or few open at the time, widely open-



ing. *Median sepal* ovate to elliptic, 2.1–3.5 by 2.1–3 mm, index c. 0.7–1.2, tip an incurved, subulate projection 1.7–2 mm long, ending in a thickened, often papillose knob; margins ciliate; rather thin; surface glabrous; abx. with a deeply lacerate median keel. *Lateral sepals* obliquely ovate, 1.5–3 by 1.2–2.5 mm, index 1.1–1.6, upper margin glabrous or finely erose, lower ciliate; tip sometimes without a subulate projection, otherwise as the median sepal. *Petals* often with a claw up to 0.9 mm long; blade orbicular to transversely elliptic, 0.7–1.8 by 1.2–1.8 mm, index 0.6–1, base often subcordate; tip rounded; margins ciliate; thin; surface glabrous. *Lip* 3-lobed, median lobe straight or recurved towards the tip, general outline ovate, 1.3–2.5 by 0.5–1.2 mm, index 1.6–2.8 (not spread), tip usually incurved, obtuse; margins glabrous; very thick; adx. concave and with a thin median ridge near the base, which continues into a median slit up to approx. half-way the lip, bordered by 2 more ridges which in front converge and in the back protrude as lobes, surface glabrous but somewhat papillose around the median slit; abx. without a median ridge, surface finely papillose; basal lobes with the frontal margins converging over the adaxial surface of the lip; forwards pointing, falcate, (narrowly) triangular, tip obtuse; glabrous; thin. *Column* from ovary to the tip of the stelidia 0.8–1.2 mm; stigma somewhat protruding at its base, orbicular; column-foot without accessories. *Stelidia* straight or falcate, narrowly triangular, 0.2–0.5 mm; tip acute; with or without a small, obtuse to acute tooth along the upper margin and with distinct, falcate, narrowly triangular tooth along the lower margin. *Anther* abx. with a ridge towards its base; front margin not protruding.

Colours – Plant light green. Rachis and flowers dark purple. Sepals dark green or purple, with dark purple to almost black hairs and tip. Petals sometimes a paler purple. Lip purple, blackish at the tip.

Ecology – Epiphyte in primary forest. Alt. 600–2300 m asl. Flowering observed in 1–4, 8–10.

Distribution – INDONESIA & PAPUA NEW GUINEA. New Guinea (central mountain range from Sudirman Ra. to Wau. Also mountain ranges N of Sepik R.).

Notes – 1. Rather similar to *Bulbophyllum nephropetalum*. The difference between the two becomes clear when the lip is observed laterally: the basal lobes in *B. erinaceum* are always forwards pointing, those in *B. nephropetalum* are backwards pointing. Additional differences can be found in the structure of the column, see Fig. 39, 40.

2. The lateral sepals may lack the subulate tip (e. g. Lam 1440).

3. Specimens from lower montane forest generally have a straight rachis, whereas in specimens from higher altitude this is generally distinctly zigzag bent. It is absolutely necessary to check the floral parts to separate such specimens from *B. nephropetalum*, which has a similarly zigzag bent (but slightly more robust) rachis.

## 15. *Bulbophyllum nephropetalum* Schltr. – Fig. 40; Plate 2a.

*Bulbophyllum nephropetalum* Schltr., Fedde, Rep. 16 (1919) 125. — Type: Kempter s.n. (B, †). Neotype: Jongejan 1342 (L).

*Rhizome* creeping, 1–3 mm diam. *Roots* spreading. *Pseudobulbs* discoid to ovoid, 0.5–1.5 cm apart, 0.2–0.4 by 0.2–0.4 cm, not laterally flattened. *Petiole* 2–5 mm. *Leaf blade* elliptic, 2–5 by 0.3–1 cm, index 3–8, tip acute. *Inflorescence* usually single, up to 28 cm, up to 55-flowered. *Peduncle* 3–5 cm, verrucose, bracts 3, the longest c. 4 mm. *Rachis* erect or arching, distinctly zigzag bent, up to 23 cm, verrucose. *Floral bracts* triangu-

lar, c. 3.5–6 mm, tip obtuse to acuminate, abx. with an erose median keel or not. *Pedicel and ovary* c. 5 mm, with the node c. 2 mm from the floral bract, surface verrucose. *Flowers* scattered, 1 open at the time, widely opening. *Median sepal* ovate, c. 4.5 by 3.2–4 mm, index 1.2–1.4, tip an incurved, subulate projection c. 0.8 mm long; margins ciliate; rather thin; surface glabrous; abx. with a deeply lacerate median keel. *Lateral sepals* oblique, 4–4.5 by 2.3–2.5 mm, index 1.6–2, tip apiculate; margins finely erose-ciliate; otherwise as the median sepal. *Petals* with a claw c. 0.8 mm long; blade approx. orbicular, 1.8–2.5 by 1.8–2.5 mm, index c. 1, base cordate; tip rounded; margins ciliate; thin; surface glabrous. *Lip* 3-lobed, median lobe slightly curved, general outline obovate, 2–2.5 by 0.5–0.8 mm, index 3–4 (not spread), tip incurved, obtuse; margins approx. glabrous, papillose near the tip; thick; adx. concave and with a small ridge near the base bordered at each side by a slit, ridge in front abruptly ending into a small concavity bordered by 2 more ridges which in front converge, surface approx. glabrous; abx. without a median ridge, surface locally papillose; basal lobes with the frontal margin inserted along the margin of the lip; backwards pointing, somewhat falcate, narrowly triangular, tip acute; glabrous; thin. *Column* from ovary to the tip of the stelia c. 2 mm; stigma somewhat protruding at its base, orbicular; column-foot with an inconspicuous, central knob close to the attachment of the lip. *Stelidia* straight, narrowly triangular, c. 0.5 mm; tip acute; with an inconspicuous, rounded, erose wing along the upper margin and a distinct, somewhat falcate, obtuse tooth along the lower margin. *Anther* abx. with a ridge towards its base; front margin not protruding.

Colours – Sepals white or pink, suffused with purple towards the margins; tip of median sepal yellow. Petals white or pink, with a purple vein. Lip white at the base, purple at the tip.

Ecology – Epiphyte along forest edges and montane shrub vegetation. Alt. 1800–2800 m asl. Flowering observed in 6, 9, 11.

Distribution – PAPUA NEW GUINEA. New Guinea (central mountain range from Hagen Ra. to Bismarck Ra. Also Saruwaged Mts).

Note – Similar to *Bulbophyllum erinaceum*; the differences are mentioned under that species.

## 16. *Bulbophyllum toranum* J.J. Smith – Fig. 41.

*Bulbophyllum toranum* J.J. Smith, Fedde, Rep. 11 (1912) 137; Nova Guinea 12, 4 (1916) 410. — Type: Gjellerup 797 (BO).

*Bulbophyllum barbellatum* Schltr., Fedde, Rep. Beih. 1 (1913) 878; 21 (1928) f. 1180. — Type: Schlechter 18510 (B, †).

*Rhizome* creeping, 1.2–2.5 mm diam. *Roots* spreading. *Pseudobulbs* discoid to ovoid, 1.5–2.2 cm apart, 0.1–0.3 by 0.3–0.35 cm, not laterally flattened. *Petiole* c. 7 mm. *Leaf blade* elliptic, 4–7 by 1.8–2.5 cm, index 2–3, tip obtuse. *Inflorescence* usually single, 12–37 cm, 5–130-flowered. *Peduncle* 9–14 cm; bracts 5–6, the longest 2.5–3 mm. *Rachis* erect or arching, often slightly zigzag bent, 2–25 cm, finely verrucose or not. *Floral bracts* ovate to triangular, 1.5–2.2 mm, tip subacute. *Pedicel and ovary* 5–7 mm, with the node 1–2.5 mm from the floral bract. *Flowers* scattered, few many open at the time, moderately opening. *Median sepal* ovate to elliptic, 3–4.2 by 1.8–2 mm, index 1.6–2.2, tip a straight or incurved, subulate projection 0.3–0.5 mm long, ending in a thickened, approx.

papillose knob; margins ciliate; thin; glabrous; abx. with or without an erose median keel. *Lateral sepals* oblique, 2.5–3.2 by 2–2.1 mm, index 1.2–1.5, tip a distinctly recurved, subulate projection; upper margin erose-papillose, lower ciliate; abx. with an inconspicuous to very distinct median keel; otherwise as the median sepal. *Petals* ovate to obovate, 1.5–2.5 by 1.3–1.5 mm, index 1.1–1.6, tip retuse to rounded; margins erose and ciliate; very thin; surface glabrous. *Lip* 3-lobed, median lobe straight, general outline elliptic, 1.5–2.2 by 0.8–1.2 mm, index 2.2–2.8 (not spread), tip rounded; margins glabrous to papillose; very thick; adx. concave and with 3 parallel, short ridges near the base, which in front end (the median may inconspicuously continue) into a median slit bordered by 2 more ridges which in front converge and in the back protrude as lobes, surface glabrous or papillose towards the margins; abx. without a median ridge, surface glabrous to papillose towards the margins and with two tufts of very distinct, elongate vesicles near the base; basal lobes with the frontal margins converging over the adaxial surface of the lip; falcate, triangular, tip acute; margins erose-papillose; thin; surface approx. glabrous. *Column* from ovary to the tip of the stelia 0.8–1.2 mm; stigma protruding at its base, elliptic; column-foot with a distinct, obtuse to approx. acute central tooth close to the attachment of the lip. *Stelidia* rather inconspicuous, triangular, 0.2–0.3 mm; tip approx. obtuse; with a distinct, forwards projecting, triangular, approx. obtuse tooth along the lower margin. *Anther* abx. with a ridge towards its base; front margin not protruding.

Colours – Sepals and petals greenish or white, suffused with purple; tips of sepals almost black. Lip purple at the base, green or yellow at the tip.

Ecology – Primary forest. Alt. 0–1000 m asl. Flowering observed in 10.

Distribution – INDONESIA & PAPUA NEW GUINEA. New Guinea (mountain ranges E of Mamberamo R.; Bismarck Ra.; Milne Bay Prov.).

Notes – 1. This species is rather similar to *Bulbophyllum bulliferum* in many aspects. Diagnostic are its petals: these are distinctly ciliate instead of erose-denticulate.

2. Variability occurs in the lip, which is more distinctly papillose in some specimens than in others.

### Series C

Rhizome creeping. Margins of petals approx. glabrous to denticulate.

## 17. *Bulbophyllum baculiferum* Ridley – Fig. 42.

*Bulbophyllum baculiferum* Ridley, Trans. Linn. Soc. II, 9 (1916) 189. — Type: Kloss s.n. (BM).

*Rhizome* creeping, 1–1.5 mm diam. *Roots* spreading. *Pseudobulbs* ovoid, 0.3–2 cm apart, 0.3–0.4 by 0.2–0.3 cm, not laterally flattened. *Petiole* 2–5 mm. *Leaf blade* elliptic, 1.5–3.2 by 0.5–1 cm, index 2.5–3, tip obtuse. *Inflorescence* usually single, 11–15 cm, up to 12-flowered. *Peduncle* 9–11 cm; bracts 4, the longest 2–3 mm. *Rachis* erect, distinctly zigzag bent, up to c. 4.5 cm. *Floral bracts* triangular, 2.5–3 mm, tip acute to acuminate. *Pedicel and ovary* c. 10 mm, with the node 2.5–3 mm from the floral bract. *Flowers* scattered, few open at the time, moderately opening. *Median sepal* ovate-elliptic, c. 4 by 2.5 mm, index c. 1.6, top emarginate with an incurved, subulate projection c. 1 mm long, ending in a ellipsoid knob; margins somewhat erose; thin; surface glabrous. *Lateral sepals* connate over most of their length, oblique, obovate, c. 6.5 by 2.8 mm, index

c. 2.3, tip an incurved, subulate projection c. 1.5 mm long; margins finely papillose; otherwise as the median sepal. *Petals* ovate-triangular, c. 2.2 by 1.2 mm, index c. 1.8, tip deeply retuse; margins finely papillose-erose; thin; surface glabrous. *Lip* 3-lobed, median lobe only slightly curved at the base, general outline ovate, c. 2 by 1.2 mm, index c. 1.7 (not spread), tip acute; approx. entirely finely papillose; thick; adx. concave and with a thick median ridge near the base, which in front is clasped between 2 inconspicuous ridges which in front converge; abx. with a distinct, retuse median ridge; basal lobes with the frontal margin inserted along the margin of the lip; large, semi-elliptic, tip rounded; approx. finely papillose; thin. *Column* from ovary to the tip of the rostellum c. 0.8 mm; stigma hardly protruding at its base, obovate; column-foot with inconspicuous, obtuse lateral wings close to the attachment of the lip. *Stelidia* approx. absent. *Anther* abx. with a ridge towards its base; front margin protruding.

Colours – Unknown.

Ecology – Unknown. Alt. c. 1000 m asl. Flowering observed in 1.

Distribution – INDONESIA. New Guinea (S slopes Sudirman Ra.).

Notes – 1. Differs from *Bulbophyllum trachypus* in not having a long, subulate tooth along the lower margins of the column. The lip is much less strongly curved, and the appendages on the sepals end in a narrowly ellipsoid knob, not an approx. globular one.

2. Known from a single specimen only.

## 18. *Bulbophyllum bulliferum* J.J. Smith – Figs. 43, 44.

*Bulbophyllum bulliferum* J.J. Smith, Bull. Dép. Agr. Ind. Néerl. 19 (1908) 5; Nova Guinea 8, 1 (1911) 90. — Type: Versteeg 1449 (BO).

*Bulbophyllum verrucibracteam* J.J. Smith, Fedde, Rep. 12 (1913) 405; Nova Guinea 12, 4 (1916) 411. — Type: Gjellerup 745 (BO).

*Bulbophyllum barbilabium* Schltr., Fedde, Rep. Beih. 1 (1913) 877; 21 (1928) f. 1177. — Type: Schlechter 20097 (holo B, †; iso AMES, BO, L).

*Rhizome* creeping, 0.75–2 mm diam. *Roots* spreading. *Pseudobulbs* orbicular to ovoid, 1–4 cm apart, 0.17–0.4 by 0.15–0.3 cm, not laterally flattened. *Petiole* 1–9 mm. *Leaf blade* elliptic, 1.3–7 by 0.8–2.2 cm, index 1.5–6, tip rounded to obtuse. *Inflorescence* usually single, 2.3–20 cm, up to 35-flowered. *Peduncle* 2–15 cm, approx. glabrous to verrucose; bracts 4–6, the longest 3–4 mm. *Rachis* erect to arching, often distinctly zigzag bent, up to 5 cm, surface as peduncle. *Floral bracts* triangular, 1–4 mm, tip acute to acuminate, abx. with a distinct median keel, surface glabrous to papillose. *Pedicel and ovary* 3–6 mm, with the node 0.8–2.5 mm from the floral bract. *Flowers* scattered, 1 or a few open at the time, moderately opening. *Median sepal* ovate to elliptic, 3–6 by 1.4–2.8 mm, index 1.6–4.2, tip a straight to incurved, subulate projection c. 0.4–1 mm long, ending in a thickened, often papillose knob; margins ciliate; thin; surface glabrous; abx. usually with an inconspicuous to distinct, erose median keel. *Lateral sepals* oblique, 3–4.5 by 1.7–2.2 mm, index 1.6–2.2, tip an upwards, inwards or downwards curved projection 0.4–1 mm long; upper margin erose, papillose or sparsely ciliate, lower ciliate; otherwise as the median sepal. *Petals* (ob)ovate to elliptic 1–2 by 0.4–0.8 mm, index 2–4, tip retuse to acute, or mucronate; margins denticulate; very thin; surface glabrous. *Lip* 3-lobed, median lobe straight or slightly curved, general outline approx. (ob)ovate, elliptic or rectangular, 2–2.5 by 0.7–1.2 mm, index 2–3 (not spread), tip retuse to obtuse; margins glabrous, papillose

to almost shortly ciliolate; rather thick; surface glabrous to partly or entirely papillose; adx. concave and with 3 parallel, short ridges near the base, which in front approx. end (often the median inconspicuously continues and protrudes again near the tip of the lip) into a median slit bordered by 2 more ridges which in front converge (and, half-way the lip, are often fused along their crests, thus overtopping the median ridge) and in the back protrude as lobes; abx. without or with an inconspicuous median ridge, with a tuft of very distinct, elongate vesicles near its base; basal lobes with the frontal margins converging over the adaxial surface of the lip; triangular to semi-elliptic, tip rounded to acute; margins erose or papillose; thin; surface glabrous to finely papillose. *Column* from ovary to the tip of the rostellum 0.5–0.7 mm; stigma protruding at its base, obovate; column-foot with a distinct, approx. acute central tooth close to the attachment of the lip. *Stelidia* absent or inconspicuous; if present triangular, tip subacute, upper as well as lower margin glabrous to erose-denticulate, with or without an inconspicuous to a distinct, forwards projecting, triangular, obtuse to acute tooth along each lower margin (or, if stelidia absent, along each lower margin of the column). *Anther* abx. with a ridge towards its base; front margin not protruding.

Colours – Sepals brown-red to dark red, sometimes greenish towards the tip; subulate projections often blackish. Median sepal sometimes white.

Ecology – Epiphytes in primary forest. Altitude 0–900 m asl. Flowering observed in 6, 7, 9.

Distribution – INDONESIA & PAPUA NEW GUINEA. New Guinea (widespread but not in Cendrawasih Peninsula and southern lowlands). – SOLOMON ISLANDS. Guadalcanal; New Georgia; San Cristobal.

Notes – 1. *Bulbophyllum toranum* differs in having ciliate, not denticulate petals.

2. *Bulbophyllum bulliferum* is variable in the presence/absence of a tooth along each lower margin of the column or stelidia, as well as in several characters of the lip. Specimens from the Solomon Islands (e.g. Hunt 2236) are characterized by a narrow, papillose lip. Similar specimens (Brass 7095, Versteeg 1449) but with a wider lip of varying outline (ovate to obovate) have been found in New Guinea. Jongejan 1573 is aberrant by its rectangular, glabrous lip (except for the tuft of vesicles abx.) with adx. a median slit which abruptly widens towards the tip. It also has only an inconspicuous tooth along each lower margin of the column. Intermediates between these forms exist, and further taxa cannot be distinguished.

3. The specimen Leiden cult. 31614 is aberrant in not having an erose crest on the abaxial surface of the sepals, as well as in having a very narrow lip with very long basal lobes. According to Schlechter's description and sketch, the type of *Bulbophyllum barbilabium* has an equally narrow lip, but is otherwise not aberrant from *B. bulliferum*. Both specimens are therefore included in *B. bulliferum*.

## 19. *Bulbophyllum parabates* J.J. Vermeulen – Fig. 45.

*Bulbophyllum parabates* J.J. Vermeulen, *Rheedea* 1 (1991) 68. — Type: LAE 67880 (Benjamin) (holo L, iso AMES, BRI, CANB, E, K, LAE).

*Rhizome* creeping, 0.8–1.6 mm diam. *Roots* spreading. *Pseudobulbs* orbicular to ovoid, 2.5–4.5 cm apart, 0.15–0.2 by 0.12–0.18 cm, hardly to moderately flattened. *Petiole* 0.5–1.5 mm. *Leaf blade* elliptic, 1.2–1.8 by 0.7–1.4 cm, index 1–2, tip rounded. *Inflores-*

*cence* usually single, 7–13 cm, up to 35-flowered. *Peduncle* 5–10 cm; bracts 5, the longest 2.5–3.5 mm. *Rachis* nodding, up to 4.5 cm. *Floral bracts* triangular, 3.5–5 mm, tip acuminate, abx. with a distinct median keel, surface somewhat papillose. *Pedicel and ovary* 3.5–5 mm, with the node 0.5–2 mm from the floral bract. *Flowers* scattered, 1 open at the time, moderately wide opening. *Median sepal* ovate, c. 3.2 by 1.3 mm, index 2.5, tip a straight, subulate projection c. 0.7 mm long, ending in a thickened, papillose knob; approx. glabrous; thin; abx. with distinct, erose median keel. *Lateral sepals* connate over 1/2–2/3 of their length, obliquely ovate to elliptic, c. 3.5 by 1.3 mm, index c. 2.8, abx. with an inconspicuous, somewhat erose keel near the base; otherwise as the median sepal. *Petals* ovate-triangular, c. 1 by 0.6 mm, index c. 1.6, tip obtuse; margins denticulate; very thin; surface glabrous. *Lip* 3-lobed, median lobe curved at the base, general outline elliptic-obovate, c. 2 by 0.8 mm, index c. 2.5 (not spread), tip rounded; thick; margins coarsely papillose-vesiculose; adx. concave and with 3 parallel, short ridges near the base, which in front are clasped between 2 more ridges which in front converge and then continue as a single median ridge and in the back protrude as lobes, surface papillose towards the margins; abx. approx. without a median ridge, surface papillose towards the margins; basal lobes with the frontal margins converging over the adaxial surface of the lip; triangular to ovate, tip obtuse; margins somewhat erose-papillose; thin; surface approx. glabrous. *Column* from ovary to the tip of the stelia c. 0.8 mm; stigma protruding at its base, obovate to elliptic; column-foot with distinct, approx. acute lateral wings close to the attachment of the lip. *Stelidia* inconspicuous, rounded; with a distinct, obtuse, tooth along the lower margin. *Anther* abx. with a ridge towards its base; front margin not protruding.

Colours – Unknown.

Ecology – One record: primary forest at 450 m asl. Flowering observed in 12.

Distribution – PAPUA NEW GUINEA. Normanby Isl.

Note – Well characterized within sect. *Lepanthanthe* by the distinct lateral wings on the column-foot. Also characteristic is the high median keel on the lip.

## 20. *Bulbophyllum quasimodo* J.J. Vermeulen – Fig. 46.

*Bulbophyllum quasimodo* J.J. Vermeulen, *Rheedea* 1 (1991) 69. — Type: Brass 7213 (holo AMES, iso L).

*Rhizome* creeping, 0.6–1.8 mm diam. *Roots* spreading. *Pseudobulbs* discoid to ovoid, 0.1–3 cm apart, 0.08–0.3 by 0.1–0.2 cm, not laterally flattened. *Petiole* 1–6 mm. *Leaf blade* elliptic, 0.9–5.3 by 0.4–1.7 cm, index 2.2–3.8, tip obtuse. *Inflorescences* single, or a few together on a short sympodium, 1.5–6.5 cm, up to 20-flowered. *Peduncle* 0.8–2 cm, bracts 2–3, the longest 1.5–2.5 mm. *Rachis* erect or arching, distinctly zigzag bent, up to 4.5 cm. *Floral bracts* triangular, 1.5–2.2 mm, tip acute, abx. with a distinct median keel. *Pedicel and ovary* 3.5–5 mm, with the node 0.8–1 mm from the floral bract. *Flowers* scattered, 1 open at the time, moderately opening. *Median sepal* ovate to elliptic, 2.2–4.5 by 2–2.2 mm, index 1–2.1, tip a straight or curved, subulate projection c. 0.4–0.6 mm long, ending in a thickened knob; margins approx. glabrous or slightly erose; thin; surface glabrous; abx. with a median keel with a lacerate crest. *Lateral sepals* oblique, transversely ovate, 1.8–2.2 by 1.8–2.0 mm, index approx. 1, top part incurved or not, with a globular projection; margins somewhat papillose, otherwise as the median sepal. *Petals* oblique, ovate, 1.2–1.5 by 0.7–1 mm, index 1.3–1.8, tip rounded; thin; glabrous. *Lip* curved to-

wards the tip, general outline ovate to elliptic, 1.3–1.5 by 0.6–0.9 mm, index 1.6–2.2 (not spread), tip obtuse; margins glabrous or very finely papillose-ciliolate; rather thick but soft; surface glabrous; adx. concave near the base, convex but furrowed along the median line towards the tip; abx. with a distinct, retuse median ridge. *Column* from ovary to the tip of the rostellum 0.7–1 mm; stigma protruding at its base, elliptic; column-foot approx. without accessories. *Stelidia* rather inconspicuous, deltoid, c. 0.2 mm; tip approx. acute; upper margin somewhat erose. *Anther* abx. with a ridge towards its base; front margin protruding.

Colours – Flowers pale green or greenish brown.

Ecology – Primary forest, reported along rivers. Alt. 100–2000 m asl. Flowering observed in 2, 7.

Distribution – INDONESIA & PAPUA NEW GUINEA. New Guinea (central mountain range: Sudirman Ra.; Victor Emanuel Ra. Also mountain ranges N of Sepik R.).

Note – This species is well characterized by its lip, without any trace of lobes near the base. *Bulbophyllum thersites* is rather similar, the differences between the two are given under that species.

## 21. *Bulbophyllum thersites* J.J. Vermeulen, *spec. nov.* – Fig. 47.

*Bulbophyllum thersites* in sect. *Lepanthanthe* labello sine lobis lateralibus tuberculo mediali basi insidenti insigniter proprium. — Typus: Reeve 4389 (K).

*Rhizome* creeping, c. 1 mm diam. *Roots* spreading. *Pseudobulbs* discoid to ovoid, 1–3 cm apart, 0.2–0.3 by 0.2–0.25 cm, not laterally flattened. *Petiole* 2–3 mm. *Leaf blade* elliptic, 3.7–4.3 by 1–2 cm, index 2–3.5, tip obtuse. *Inflorescences* single, or a few together on a short sympodium, 1.5–5.5 cm, up to 36-flowered. *Peduncle* 0.5–1.8 cm, bracts 3, the longest c. 2 mm. *Rachis* arching or nodding at the base, distinctly zigzag bent, up to 6.5 cm. *Floral bracts* triangular, 1.8–2.5 mm, tip acute to acuminate, abx. with a distinct median keel. *Pedicel and ovary* 7–7.5 mm, with the node 1–1.3 mm from the floral bract. *Flowers* scattered, 1 open at the time, moderately opening. *Median sepal* elliptic, c. 4.5 by 3.5 mm, index 1.3, tip an approx. straight, subulate projection c. 1 mm long, ending in a thickened knob; margins finely papillose; thin; surface glabrous; abx. with a median keel with a lacerate crest. *Lateral sepals* oblique, approx. orbicular, c. 2.8 by 2.5 mm, index c. 1.1, top part incurved, with a globular projection; otherwise as the median sepal. *Petals* ovate, c. 1.7 by 1.2 mm, index c. 1.4, tip subacute; thin; glabrous. *Lip* curved towards the base and towards the tip, general outline ovate, c. 1.8 by 1 mm, index c. 1.8 (not spread), tip acute; margins distinctly ciliate; rather thin and soft; surface entirely very finely papillose; adx. slightly concave but with a distinct median thickening near the base, slightly convex towards the tip; abx. with a distinct, retuse median ridge. *Column* from ovary to the tip of the rostellum c. 1 mm; stigma with a distinctly protruding tooth at its base, approx. orbicular; column-foot approx. without accessories. *Stelidia* deltoid, c. 0.3 mm; tip approx. acute; upper margin somewhat erose, lower margin with an inconspicuous, deltoid, rounded wing. *Anther* abx. with a ridge towards its base; front margin protruding.

Colours – Sepals and petals pale greenish with pink. Lip white and pink.

Ecology – Epiphyte in primary forest. Alt. 1100 m asl. Flowering observed in 2 (all from one record).

Distribution – PAPUA NEW GUINEA. New Guinea (Southern Highlands Prov.).

Notes – 1. *Bulbophyllum thersites* is rather similar to *B. quasimodo*, but it differs in having a distinct swelling on the adaxial side of the lip, close to the base. It also has a distinct tooth at the base of the stigma.

2. The flowers of this species have a rather ‘malicious’ appearance; the species has therefore been named after a nasty character featuring in Greek mythology.

## 22. *Bulbophyllum trachypus* Schltr. – Fig. 48.

*Bulbophyllum trachypus* Schltr, Fedde, Rep. Beih. 1 (1913) 878; 21 (1928) f. 1179. — Type: Schlechter 18573 (holo B, †; iso K).

*Rhizome* creeping, 1–1.5 mm diam. *Roots* spreading. *Pseudobulbs* discoid to ovoid, 0.5–2 cm apart, 0.25–0.4 by 0.2–0.3 cm, not laterally flattened. *Petiole* 4–8 mm. *Leaf blade* elliptic to slightly obovate, 3–4.5 by 1–2 cm, index 1.6–4.5, tip obtuse. *Inflorescence* usually single, 18–25 cm, up to 30-flowered. *Peduncle* 14–16 cm, coarsely verrucose; bracts 4, the longest 3–4.5 mm. *Rachis* erect, at most slightly zigzag bent, up to c. 9 cm, surface as peduncle. *Floral bracts* triangular, 4–5 mm, tip acute to acuminate. *Pedicel and ovary* c. 14 mm, with the node 4–5 mm from the floral bract. *Flowers* scattered, few open at the time, moderately opening. *Median sepal* elliptic, c. 6 by 6 mm, index c. 1, top emarginate with a straight to recurved, subulate projection c. 1.5 mm long, ending in a globular knob; margins glabrous to papillose; thin; surface glabrous. *Lateral sepals* connate over most of their length, oblique, c. 5.5 by 4 mm, index c. 1.3, tip an incurved, subulate projection c. 2 mm long; margins finely papillose; otherwise as the median sepal. *Petals* elliptic, c. 3 by 1.5 mm, index c. 2, tip rounded to acute-acuminate; margins glabrous to finely erose; thin; surface glabrous. *Lip* 3-lobed, median lobe distinctly curved, general outline elliptic, c. 1.5 by 0.7 mm, index c. 2 (not spread), tip obtuse; approx. entirely finely papillose; thick; adx. concave and with 3 parallel ridges near the base, which in front abruptly end into a triangular concavity bordered by 2 more ridges which in front converge; abx. with a distinct, retuse median ridge; basal lobes with the frontal margin inserted along the margin of the lip; large, semi-elliptic, tip rounded; front margin distinctly ciliate; thin; surface glabrous, papillose towards the margins. *Column* from ovary to the tip of the rostellum c. 1.5 mm; stigma protruding at its base, obovate; column-foot with inconspicuous, obtuse lateral wings close to the attachment of the lip. *Stelidia* approx. absent, lower margins of the column with a distinct, straight, subulate, acute tooth of c. 1.3 mm long. *Anther* abx. with a ridge towards its base; front margin protruding.

Colours – Flowers pale yellow to yellowish green, sometimes tinged pink; or flowers dark purple.

Ecology – Primary forest. Alt. 1300–2500 m asl. Flowering observed in 6, 9, 11.

Distribution – INDONESIA & PAPUA NEW GUINEA. New Guinea (central mountain range: Western Highlands Prov.; Chimbu Prov. Also Cycloop Ra.).

Notes – 1. The basal lobes which are inserted along the margins of the lip, instead of converging over its adaxial surface in front, as well as the long tooth along the lower margins of the column, characterize this species among those of sect. *Lepanthanthe* with a creeping rhizome.

2. This species is similar to *Bulbophyllum baculiferum*; see the note under the latter species.



## INCOMPLETELY KNOWN SPECIES

### ***Phreatia globulosa* Ridley**

*Phreatia globulosa* Ridley, Trans. Linn. Soc. 11, 9 (1916) 197. — Type: Kloss s.n. (BM).

Note — The type specimen is undoubtedly a *Bulbophyllum* species of sect. *Lepanthanthe*. Probably it is either *B. quasimodo* or *B. thersites*, two species which only differ in the shape of the flowers. Unfortunately no flowers are left on the type specimen. Besides, Ridley describes the shape of the lip as hastate, while both species mentioned do not have a hastate lip. An unambiguous interpretation of *Phreatia globulosa* is therefore not possible.

### ***Bulbophyllum mystrophyllum* Schltr.**

*Bulbophyllum mystrophyllum* Schltr., Fedde, Rep. 16 (1919) 124. — Type: Kempter s.n. (B, †).

Note — The type, originating from Papua New Guinea, was destroyed. No material which can be attributed to this species has been seen by the author. According to Schlechter's description, it must be rather similar to *Bulbophyllum cruttwellii* and *B. lepanthiflorum* vegetatively. Contrary to those two species, the lip is only 'slightly widened' towards the base; real lobes seem not to be present. The petals are probably sessile (Schlechter does not mention a claw) and have a glabrous margin.

## **Section Macrouris**

*Bulbophyllum* section *Macrouris* Schltr., Fedde, Rep. Beih. 1 (1913) 703 & 865. — Lectotype species: *Bulbophyllum macrourum* Schltr.

*Bulbophyllum* section *Ischnopus* Schltr., Fedde, Rep. Beih. 1 (1913) 704 & 872; P. Royen, Alpine Fl. New Guinea 2 (1979) 233. — Lectotype species: *B. habropus* Schltr. (= *B. orbiculare*; design. P. Royen).

*Bulbophyllum* section *Hedyothyrsus* Schltr., Fedde, Rep. Beih. 1 (1913) 705 & 885. — Lectotype species: *Bulbophyllum chloranthum* Schltr.

*Rhizome* creeping, or patent to pendulous; rhizome scales shorter or longer than the internodes they cover. *Roots* generally sprouting below the pseudobulbs only; or below the older pseudobulbs in case the rhizome is not creeping (rarely sprouting along the entire rhizome, this sometimes observed in *B. dichotomum*). *Inflorescence* usually with 2 or more flowers, sometimes with 1 flower (*glaucum*). *Median sepal*: tip emarginate to caudate. *Petals* distinct, not very small. *Lip* not divided into lobes; lip above the ligament without a concavity with two teeth in front. *Column*: rostellum somewhat protruding in lateral view or not; base of the stigma protruding in lateral view, or not (Series C), without teeth or with 1 (*musciicola*) or 3 (*olivinum*) teeth; column-foot approx. without accessories, sometimes with small lateral wings. *Stelidia* present but sometimes inconspicuous, without a tooth along their lower margin, or with a forwards or downwards directed, straight, deltoid to triangular, rounded to acute tooth along their lower margin. *Pollinia* 2 but sometimes 4 (*callichroma*, *chloranthum*, *desmotrichoides*, *imitator*), if 4 the inner pair c. half as long as the outer pair or smaller. *Stipes* absent or very inconspicuous.

Notes – 1. Section *Peltopus* excepted, the sections revised in this volume together are characterized by the following polythetic set: ‘Inflorescence with more than one flower; node between rachis and pedicel shifted (up to a few mm) from its bract in the direction of the flower’. Among these sections, sect. *Macrouris* is mainly characterized by the absence of unique characters: it does not have subulate appendages and lobes at the base of the lip as in sect. *Lepanthanthe*; it does not have the typical tooth along the lower margin of the stelia occurring in sect. *Uncifera*, and it does not have a lump on the column-foot fitting into a cavity in the lip as in sect. *Pelma* and *Peltopus*. Only from sect. *Adelopetalum* it can be distinguished by the presence of a character: ‘base of the stigma protruding’, although in Series C of sect. *Macrouris* a small number of species is included which lack this protrusion. Otherwise, however, the latter species are similar to species in sect. *Macrouris*. Therefore they are best included in this section, rather than in sect. *Adelopetalum*.

2. Other sections of *Bulbophyllum* with a racemose inflorescence do not show a displacement of the node between the rachis and the pedicel (two Bornean species of sect. *Hirtula* excepted: *Bulbophyllum jolandae* J.J. Vermeulen and *B. rariflorum* J.J. Smith). Examples of such sections containing species which are similar to those of sect. *Macrouris* are: sect. *Aphanobulbon* which differs in generally having much smaller pseudobulbs (although e.g. the species *B. catorum* and *mulderae* of sect. *Macrouris* also have minute pseudobulbs); the racemose species of sect. *Sestochilus*, e.g. *B. alticaule* Ridley (New Guinea) and *B. foetidolens* Carr (Borneo), which differ in having 4 pollinia, with the inner pair distinctly more than half as long as the outer pair, and in having petals with 3 or more veins (not 1 as in sect. *Macrouris*).

Section *Macrobulbon* is much larger in all parts, with much wider, fleshy sepals.

The sections *Nematorhizis* and *Oxysepalum* both contain species which are very similar to species of sect. *Macrouris*. These sections differ in having a 1-flowered inflorescence; read also note 4 under *Bulbophyllum muscicola*, as well as note 2 under *B. glaucum*.

3. A number of species within this section have comparatively ‘simple’ flowers with few outstanding characters. To distinguish between these species in the key, much emphasis has been laid on vegetative characters.

Since these characters cannot be observed from herbarium material, it is important to add notes on the position of the rhizome when collecting specimens. The rhizome can be:

- entirely creeping;
- idem, but with the most recently developed parts patent or pendulous;
- entirely erect or patent (attached to the substratum at its very base only);
- pendulous (attached to the substratum at its very base only) but with more or less patent branches;
- pendulous, all the branches perpendicularly hanging downwards.

#### KEY TO THE SPECIES OF SECTION MACROURIS

- 1a. Stelidia distinct, subulate (Series A) . . . . . 2
- b. Stelidia inconspicuous, deltoid to narrowly triangular . . . . . 3
- 2a. Leaves flat. Lateral sepals connate, or with the lower margins (partly) touching . . . . . 23. *B. grammopoma*
- b. Leaves semi-terete. Lateral sepals free, widely spreading . . . . . 24. *B. sceliphron*

- 3a. (1) Base of stigma distinctly protruding from the face of the column in lateral view, or base of stigma with 1–3 protruding knobs or teeth (Series B). . . . . 4
- b. Base of stigma not at all protruding from the face of the column in lateral view, and without teeth (Series C) . . . . . 24
- 4a. Lip adaxially without ridges, or with 2 ridges. No median ridge is present . . . . . 5
- b. Lip adaxially with 1 ridge, or with 3, 4 or 5 ridges which may partly be fused. A median ridge is often present (look carefully, it may be somewhat inconspicuous. Take also care with herbarium specimens, ridgelike structures may develop due to lateral compression during the drying process). . . . . 21
- 5a. Plant with rhizomes erect, patent or pendulous, attached to the substratum at the very base only; or plant hanging down perpendicularly along the substratum, attached to it at the very base and otherwise at most loosely clinging to it with a few roots. . . . . 6
- b. Plant with rhizomes creeping, forming a straggling mat, attached to the substratum over much of its length, often with the most recently developed parts patent or approx. pendulous . . . . . 13
- 6a. All rhizome scales (take care to check undamaged scales in a flowering portion of the plant, and measure from base to tip) longer than the internode they cover, thus (almost) entirely covering the rhizome. . . . . 7
- b. Rhizome scales covering the longest internodes distinctly shorter than that internode, thus leaving bare large portions of the rhizome. . . . . 9
- 7a. Leaves cordate at the base. Leaf index c. 1.6. Plants pendulous (except for very young, short, branches which may be patent), hanging down perpendicularly from, or along the substratum . . . . . **26. B. cardiophyllum**
- b. Leaf base gradually narrowed into the petiole. Leaf index 4–14. Plants patent, or more or less pendulous but not hanging down perpendicularly . . . . . 8
- 8a. Median sepal 1.5–3 mm wide. Petals 1.2–2.2 mm long. Lip divided in a wide basal part and a narrow top part . . . . . **43. B. pidacanthum**
- b. Median sepal 3.5–5.5 mm wide. Petals 3–4.5 mm long. Lip ovate in outline  
**44. B. scopa**
- 9a. (6) Median sepal with finely papillose-ciliolate margins. 3.2. Lateral sepals connate. Lip adaxially with 2 distinct ridges which converge in front . . . . . **38. B. myon**
- b. Median sepal with glabrous margins. Lateral sepals free. Lip either without ridges or with 2 very inconspicuous ridges which run approx. parallel . . . . . 10
- 10a. Index of most leaves in a fully grown (flowering) portion of the plant 3–33; or index of most leaves of a fully grown portion of the plant 1.8–3, but then rhizomes not longer than 4 cm . . . . . **45. B. trifilum**
- b. Index of most leaves in a fully grown portion of the plant 1.1–2.9; rhizomes longer than 4 cm . . . . . 11
- 11a. Rhizome portion between two pseudobulbs usually with a node at 1/4 to 1/2 of its length. Lip in lateral view approx. equally thick up to, or over half-way its length. Inflorescence with 3–9 flowers . . . . . **35. B. macrourum**

- b. Rhizome portion between two pseudobulbs usually without a node approx. half-way, sometimes with a node at approx. 2/3 of its length. Lip in lateral view thickest near the base. Inflorescence with 1–3 flowers . . . . . 12
- 12a. Leaves 0.8–2.5 cm long. Median sepal 22–28 mm long. Base of the stigma rounded in lateral view . . . . . 27. **B. cateurum**
- b. Leaves 0.5–1.3 cm long. Median sepal 13–15 mm long. Base of the stigma angular in lateral view . . . . . 36. **B. mulderae**
- 13a. (5) Median sepal with 2 distinct folds along its midvein, near its base. Pollinia 4 (look carefully, the inner pair is small) . . . . . 25. **B. callichroma**
- b. Median sepal without folds near its base. Pollinia 2 . . . . . 14
- 14a. Median sepal 55–85 mm long . . . . . 31. **B. fonsflorum**
- b. Median sepal 2.8–30 mm long . . . . . 15
- 15a. Column when viewed from aside with the protruding base of the stigma only just visible below the lower margins of the stelidia (see Fig. 22a) . . 29. **B. decockii**
- b. Column when viewed from aside with the protruding base of the stigma clearly visible far below the lower margins of the stelidia (see Fig. 22b, c) . . . . . 16
- 16a. Stelidia with a distinct, deltoid to triangular, rounded to acute tooth along the lower margin, well below the rostellum (see Fig. 22d) . . . . . 34. **B. levatii**
- b. Stelidia without, or with a very inconspicuous tooth along the lower margin (do not confuse true teeth along the lower margins of the stelidia with the protruding rostellum; see Fig. 22e) . . . . . 17
- 17a. Lip straight or only very slightly curved; or lip in lateral view more or less divided in a thick, often approx. semi-circular basal part, and a much thinner, approx. flat top part (see Fig. 22f, g); or both characters present . . . . . 18
- b. Lip distinctly curved, gradually flattening towards the tip in lateral view (see Fig. 22h, i) . . . . . 19
- 18a. Top part of the lip rather thin, but of solid texture. Inflorescence with 10–35 flowers  
30. **B. dendrochiloides**
- b. Top part of the lip thick but of a soft, spongy texture. Inflorescence with 2–10 flowers . . . . . 42. **B. phormion**
- 19a. (17) Inflorescence shorter than the length of the pseudobulb plus leaf from which it arises. Rhizomes creeping, but with the most recently developed parts often patent or pendulous . . . . . 33. **B. kaniense**
- b. Inflorescence longer than the length of the pseudobulb plus leaf from which it arises. Rhizomes entirely creeping . . . . . 20
- 20a. Index median sepal 1.2–3. Base of stigma with a protruding tooth  
37. **B. muscicola**
- b. Index median sepal 4.5–10. Base of stigma protruding but without a tooth  
41. **B. oreodoxa**

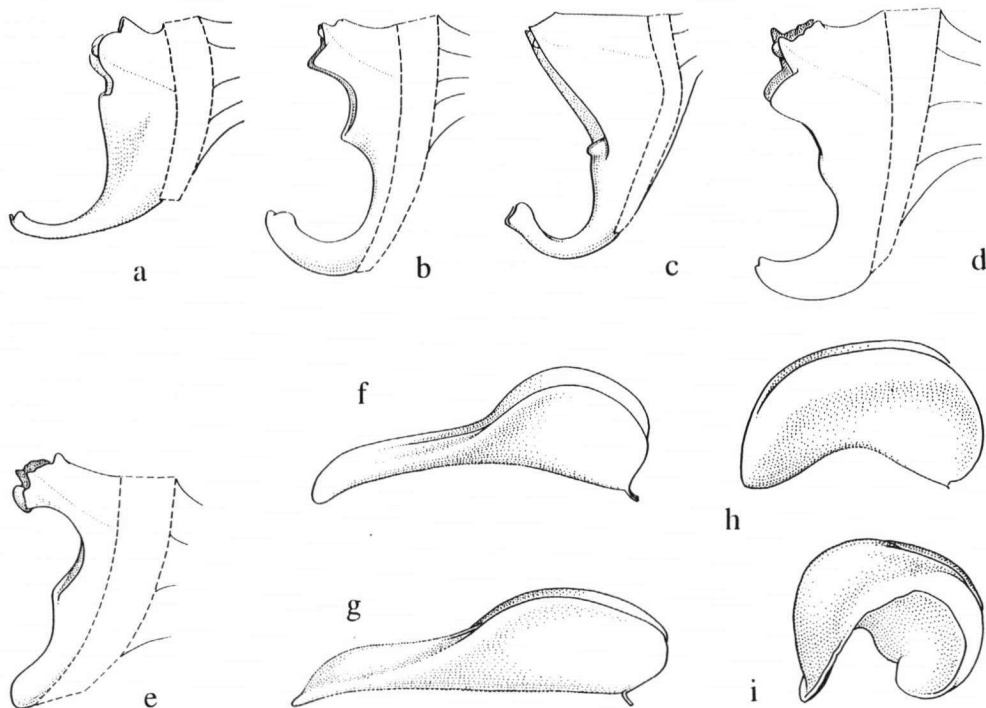

Fig. 22. Explanatory sketches with the key to the species of *Macrouris*.

- 21a. (4) Median sepal with 2 distinct folds along its midvein, near its base. Lateral sepals 18–46 mm long . . . . . 28. **B. chloranthum**  
 b. Median sepal without folds near its base. Lateral sepals 2.7–12 mm long . . . . . 22
- 22a. Lateral sepals 8–14 mm long. Leaf blade in flowering portion of the plant 1.5–4 cm wide. Ridges on the adaxial side of the lip fused to a single, median ridge in the basal half of the lip (which continues to the top half of the lip) . . . . . 39. **B. olivinum**  
 b. Lateral sepals 2.6–8 mm long. Leaf blade in flowering portion of the plant 0.3–1.4 cm wide. Ridges on the adaxial side of the lip not fused, or only so in the top half of the lip . . . . . 23
- 23a. Margins of lip glabrous to finely papillose. Lip distinctly ovate. Top part of the lip straight or only slightly curved . . . . . 32. **B. graciliscapum**  
 b. Margins of lip usually distinctly ciliate; if not then *either* lip obovate to approx. elliptic and equally wide over most of its length or only very slightly tapering towards the tip; *or* lip ovate but then the top of the lip distinctly curved  
40. **B. orbiculare**
- 24a. (3) Lip distinctly curved in lateral view . . . . . 25  
 b. Lip straight or only very slightly curved in lateral view . . . . . 26

- 25a. Pseudobulbs inconspicuous, 0.15–0.25 cm long. Median sepal 12.5–25 mm long. Lip 5–7 mm long . . . . . 48. *B. glaucum*  
 b. Pseudobulbs distinct, 0.6–2.2 cm long. Median sepal 5–6 mm long. Lip 1.5–1.8 mm long . . . . . 49. *B. imitator*
- 26a. (24) Inflorescence with 5–20 flowers. Pollinia 4 . . . . 46. *B. desmotrichoides*  
 b. Inflorescence with (1–)2 flowers. Pollinia 2 . . . . . 47. *B. dichotomum*

**Series A**

Base of the stigma distinctly protruding from the face of the column. Stelidia subulate.

**23. *Bulbophyllum grammopoma* J.J. Vermeulen – Fig. 49.**

*Bulbophyllum grammopoma* J.J. Vermeulen, *Rheedea* 1 (1991) 72. — Type: Jongejan 1578 (L).

*Rhizome* creeping, 1.5–4 mm diam.; all rhizome scales slightly shorter to longer than the internodes. *Roots* in tufts below each pseudobulb. *Pseudobulbs* ovoid, 0.8–3.5 cm apart, 0.8–2 by 0.4–1.5 cm, not flattened. *Petiole* 8–15 mm. *Leaf blade* elliptic, 6.5–11 by 0.3–1.5 cm, index 6–22, tip obtuse to acute. *Inflorescence* 11.5–46 cm, 7–35-flowered. *Peduncle* 7.8–27 cm, bracts 3–4, the longest 4–12 mm. *Rachis* erect or arching, 3.8–19 cm. *Floral bracts* elliptic, 2.5–4 mm, tip acute. *Pedicel and ovary* 4.5–9 mm, with the node c. 1 mm from the floral bract; ovary glabrous. *Flowers* all open at the time, moderately opening. *Median sepal* elliptic, 5.5–9 by 3.6–6.5 mm, index 1.2–1.8, tip acuminate; margins glabrous or slightly erose, rather thin; surface glabrous. *Lateral sepals* connate or with the lower margins (partly) touching, oblique, ovate, 16–24 by 2–4 mm, index 4.4–8, tip acute; glabrous; otherwise as the median sepal. *Petals* oblique, ovate to elliptic, 2–4 by 1.5–3.2 mm, index 1.2–1.4, tip rounded to acute; margins glabrous or slightly erose; rather thin; surface glabrous. *Lip* curved, general outline ovate, 2.2–3.8 by 1.3–2.2 mm, index 1.5–2 (not spread), tip obtuse to acute; thick; glabrous; adx. concave towards the base, with an inconspicuous median ridge, with 2 other ridges converging in front in the basal half; abx. with a distinct, retuse median ridge. *Column* from ovary to the tip of the stelidia 1.5–3 mm; stigma with a distinct tooth at its base, subtriangular; column-foot without accessories. *Stelidia* subulate, 0.6–1.2 mm; tip acute. *Anther* abx. with a ridge towards its base; front margin not protruding. *Pollinia* 2.

*Colours* – Pseudobulbs suffused with purple. Leaves dark green. Median sepal and petals white, yellow or pale greenish, with purple veins. Lateral sepals yellow, yellowish green or purple except for the base. Lip and column yellow or greenish.

*Ecology* – Epiphyte in primary forest. Also recorded from open forest, on an exposed tree. Alt. 1600–2600 m asl. Flowering observed in 1, 3, 4, 8–11.

*Distribution* – INDONESIA & PAPUA NEW GUINEA. New Guinea (central mountain range from Sudirman Ra. to Owen Stanley Ra.).

*Note* – Differs from *Bulbophyllum sceliphron* by its flat leaves as well as the connate lateral sepals.

**24. *Bulbophyllum sceliphron* J.J. Vermeulen – Fig. 50.**

*Bulbophyllum sceliphron* J.J. Vermeulen, Rheedea 1 (1991) 75. — Type: Reeve 759 (holo L, iso K, LAE).

*Rhizome* creeping, 1–1.8 mm diam.; all rhizome scales slightly shorter to longer than the internodes. *Roots* in tufts below each pseudobulb. *Pseudobulbs* ovoid, 0.6–2 cm apart, 0.5–1.5 by 0.2–1.1 cm, not flattened. *Petiole* 3–10 mm. *Leaf blade* semi-terete, 4–9 by 0.2–0.4 cm, index 20–30, tip acute. *Inflorescence* 13–24 cm, 8–18-flowered. *Peduncle* 10–20 cm; bracts 4–5, the longest 5–7 mm. *Rachis* erect or arching, 2.4–4.5 cm. *Floral bracts* ovate, 1.8–2.5 mm, tip acute. *Pedicel and ovary* 6–9 mm, with the node 1–1.5 mm from the floral bract; ovary glabrous. *Flowers* all open at the time, widely opening. *Median sepal* elliptic, c. 4 by 3 mm, index c. 1.3, tip acuminate; rather thin; glabrous. *Lateral sepals* oblique, c. 6 by 2.3 mm, index c. 2.6, otherwise as the median sepal. *Petals* ovate, c. 2.2 by 1.7 mm, index c. 1.3, tip (sub)acute; margins erose towards the tip; thin; surface glabrous. *Lip* curved at the base, general outline ovate, c. 4 by 1.3 mm, index c. 3 (not spread), tip obtuse; margins somewhat finely papillose; thick; surface glabrous; adx. concave near the base, with an inconspicuous median ridge, with 2 distinct ridges converging in front in the basal half; abx. with an inconspicuous, truncate median ridge. *Column* from ovary to the tip of the stelia c. 2 mm; stigma with a distinct tooth at its base, elliptic; column-foot with small wings close to the attachment of the lip. *Stelidia* subulate, c. 1 mm; tip acute. *Anther* abx. with a ridge towards its base; front margin somewhat protruding. *Pollinia* 2.

Colours – Sepals brownish with greenish yellow margins. Petals (greenish) yellow. Lip greenish brown with yellow tip.

Ecology – Alt. 2000 m asl. (one record). Flowering observed in 5, 10.

Distribution – PAPUA NEW GUINEA. New Guinea (central mountain range: Chimbu Prov.; Owen Stanley Ra.).

Note – The differences from *Bulbophyllum grammopoma* are given under the latter species.

**Series B**

Base of the stigma distinctly protruding from the face of the column.

Stelidia deltoid, triangular or semicircular.

**25. *Bulbophyllum callichroma* Schltr. – Fig. 51; Plate 2b.**

*Bulbophyllum callichroma* Schltr., Fedde, Rep. Beih. 1 (1913) 886; 21 (1928) f. 1191. — Type: Schlechter 18136 (holo B, †; iso AMES, K).

*Bulbophyllum calothyrsus* Schltr., Fedde, Rep. Beih. 1 (1913) 886; 21 (1928) f. 1193. — Type: Schlechter 20137 (holo B, †).

*Bulbophyllum manifestans* J.J. Smith, Nova Guinea 14, 3 (1929) 470. — Type: Feuilletau De Bruyn 98 (BO, L).

*Rhizome* creeping, 1.5–3 mm diam.; all rhizome scales slightly shorter to longer than the internodes. *Roots* in tufts below each pseudobulb. *Pseudobulbs* ovoid, 2–7 cm apart, 0.7–1.5 by 0.6–1.5 cm, not laterally flattened. *Petiole* 6–20 mm. *Leaf blade* ovate to elliptic, 4.5–16 by 1.4–2.3 cm, index 3–8.7, tip acute to acuminate. *Inflorescence* 18–43 cm,

4–14-flowered. *Peduncle* 12.5–30 cm; bracts 5–8, the longest 4–7 mm. *Rachis* approx. pendulous, 4.5–13 cm. *Floral bracts* triangular, 2–4 mm, tip acute. *Pedicel and ovary* 6–8.5 mm, with the node 0.8–2.5 mm from the floral bract. *Flowers* many open at the time, moderately opening. *Median sepal* with two folds along the midvein near the base, ovate, 9–19 by 3–8 mm, index 1.9–3.5, tip acute to acuminate; rather thin, often thickened towards the tip; glabrous. *Lateral sepals* usually connate (see note), oblique, ovate to elliptic, 10–24 by 3.3–7.5 mm, index 3.2–5, tip acute to acuminate; rather thin; glabrous. *Petals* ovate to elliptic, 3.2–7 by 2–4 mm, index 1.4–1.9, tip obtuse to acute; thin; glabrous. *Lip* curved, general outline ovate to sub-panduriform, 2–3 by 1–1.8 mm, index 1.4–2 (not spread); tip rounded; thick; glabrous; adx. concave near the base, with 2 distinct ridges converging and fused in front approx. half-way, abx. with a retuse median ridge. *Column* from ovary to the tip of the stelia 1.3–2 mm; stigma with a distinct tooth at its base, approx. sickle-shaped; column-foot approx. without accessories. *Stelidia* (obliquely) truncate. *Anther* abx. with a ridge towards its base; front margin protruding. *Pollinia* 4; the inner pair less than half as long as the outer pair.

Colours – Median sepal white with a yellow tip, or entirely yellow, with or without purple stains or veins. Lateral sepals purple, sometimes with whitish margins. Petals white. Lip purple.

Ecology – Epiphyte in primary forest. Alt. 600–2200 m asl. Flowering observed in 5–11.

Distribution – INDONESIA & PAPUA NEW GUINEA. New Guinea (probably widespread but from scattered localities only; not in the southern lowlands); New Ireland.

Notes – 1. The differences from *Bulbophyllum chloranthum* are given under the latter species.

2. The length of the sepals may vary considerably.

3. In NGF 12624 (Womersley & Thorne) the lateral sepals of all flowers are free. In Jongejan 119 a few flowers have free lateral sepals, although in most flowers they are firmly connate. Otherwise these specimens are not aberrant.

## 26. *Bulbophyllum cardiophyllum* J.J. Vermeulen – Fig. 52; Plate 2c.

*Bulbophyllum cardiophyllum* J.J. Vermeulen, *Rheedea* 1 (1991) 75. — Type: Jongejan 1379 (L).

*Rhizome* hanging down perpendicularly, flattened; all rhizome scales longer than the internodes. *Roots* generally close to the base of the rhizome. *Pseudobulbs* approx. cylindrical, 0.5–1 cm apart, c. 0.7 by 0.3 cm, hardly flattened. *Petiole* c. 1.5 mm. *Leaf blade* ovate, base cordate, c. 3.5 by 2.3 cm, index c. 1.6, tip acuminate. *Inflorescence* 6–8 cm, 5–7-flowered. *Peduncle* c. 4 cm; bracts (?), the longest c. 8 mm. *Rachis* arching or pendulous, 1.2–2 cm. *Floral bracts* ovate, 5–8 mm, tip acute. *Pedicel and ovary* 3–4 mm, with the node c. 0.7 mm from the floral bract. *Flowers* all open at the time, moderately opening. *Median sepal* ovate to triangular, 18–22 by 2.8 mm, index 6.5–8, tip long acuminate to caudate; thin; glabrous. *Lateral sepals* free, oblique, triangular, 18–23 by 3 mm, index 6–7.7, otherwise as the median sepal. *Petals* elliptic, c. 3.3 by 1.8 mm, index c. 1.8, tip obtuse; thin; glabrous. *Lip* curved, general outline ovate, c. 2.7 by 1.6 mm, index c. 1.7 (not spread), tip rounded; thick but soft; glabrous; adx. concave near the base; abx. with a retuse median ridge. *Column* from ovary to the tip of the stelia c. 0.7 mm; stigma pro-



truding at its base, obovate; column-foot without accessories. *Stelidia* inconspicuous, triangular, tip acute. *Anther* with an inconspicuous ridge; front margin protruding. *Pollinia* 2.

Colours – Leaves slightly suffused with purple. Flowers entirely cream-coloured; lip adx. with a purple blotch.

Ecology – Epiphyte in primary forest along stream. Alt. c. 2300 m asl. Flowering (?) (all from one record).

Distribution – PAPUA NEW GUINEA. New Guinea (central mountain range: Eastern Highlands Prov.).

Notes – 1. Among the species with the rhizome hanging down perpendicularly, *Bulbophyllum cardiophyllum* is characterized by the rhizome scales which are all longer than the internodes, as well as by the floral bracts which are distinctly longer than the pedicel plus ovary.

2. Only a single specimen, consisting of a leaf and a few loose inflorescences preserved in spirit, was available for this revision. The description and the drawing of the habitus have been supplemented from photographs of the plant.

## 27. *Bulbophyllum cateorum* J.J. Vermeulen – Fig. 53; Plate 2d.

*Bulbophyllum cateorum* J.J. Vermeulen, *Rheedea* 2 (1992) 1. — Type: Jongejan 1236 (L).

*Rhizome* hanging down perpendicularly, up to 70 cm long, flattened and winged, largest diam. 0.8–1.5 mm; rhizome portion between two pseudobulbs usually without a node approx. half-way, sometimes with a node at approx. 2/3 of its length; rhizome scales of the longest internodes distinctly shorter than those internodes, leaving bare large portions of the rhizome. *Roots* generally close to the base of the rhizome. *Pseudobulbs* cylindrical, 1.2–3.5 cm apart, 0.1–0.35 by 0.08–0.15 cm, not flattened. *Petiole* 0.8–1.5 mm. *Leaf blade* ovate to elliptic, base often cordate, 0.8–2.5 by 0.7–2.2 cm, index 1.1–2, tip acuminate. *Inflorescence* 3.5–5 cm, 1–3-flowered. *Peduncle* 0.5–2 cm; bracts c. 3, the longest 3.5–5 mm. *Rachis* 0.2–0.6 cm. *Floral bracts* triangular, 2.8–4 mm, tip acuminate. *Pedicel and ovary* 4.5–7 mm, with the node 1.3–2 mm from the floral bract. *Flowers* all open at the time, moderately opening. *Median sepal* ovate, 22–28 by 3 mm, index 7–10; tip long acuminate to caudate; thin; glabrous. *Lateral sepals* free, oblique, triangular, 22–28 by 3–3.5 mm, index 7–10, otherwise as the median sepal. *Petals* elliptic, 3–4 by 1.8–2.5 mm, index 1.6–2, tip acute; thin; glabrous. *Lip* curved, general outline ovate, in lateral view highest near the base, 3.5–4.5 by 1.8–2 mm, index 1.6–2 (not spread), tip obtuse; thick but soft; glabrous; adx. concave near the base; abx. with an inconspicuous, retuse median ridge. *Column* from ovary to the tip of the stelidia 1–1.3 mm; stigma protruding at its base (base of stigma rounded in lateral view), approx. triangular; column-foot approx. without accessories. *Stelidia* inconspicuous, triangular, tip acute; with a small, approx. subacute tooth along the upper margin. *Anther* abx. with a ridge towards its tip; front margin protruding. *Pollinia* 2.

Colours – Sepals white or pinkish. Lip dark purple at the tip.

Ecology – Epiphyte in primary forest, or in isolated trees in open vegetation. Alt. 1700–2500 m asl. Flowering observed in 4, 7, 9.

Distribution – INDONESIA & PAPUA NEW GUINEA. New Guinea (central mountain range: Sudirman Ra.; Chimbu Prov.; Eastern Highlands Prov.).

Note – Similar to *Bulbophyllum mulderae*, but larger in all parts and with the protruding base of the stigma rounded in lateral view, not angular. It differs from *B. macrourum* in usually not having a rhizome scale at 1/4 to 1/2 of the rhizome portion between two pseudobulbs, as well as in the lip which tapers towards the tip in lateral view.

## 28. *Bulbophyllum chloranthum* Schltr. – Fig. 54.

*Bulbophyllum chloranthum* Schltr. in Schum. & Laut., Nachtr. (1905) 197; Fedde, Rep. Beih. 1 (1913) 886; 21 (1928) f. 1192. — Type: Schlechter 14642 (holo B, †; iso BO, K, P).

*Bulbophyllum macgregorii* Schltr., Fedde, Rep. 10 (1911) 252; id., Beih. 1 (1913) 872; 21 (1928) f. 1171. — Type: Mac Gregor s.n. (not seen).

*Bulbophyllum hedyothyrsus* Schltr., Fedde, Rep. Beih. 1 (1913) 887; 21 (1928) f. 1194. — Type: Schlechter 18497 (holo B, †; iso K).

? *Bulbophyllum arcuatum* Schltr., Fedde, Rep. 17 (1921) 378. — Type: Kempf s.n. (B, †).

*Bulbophyllum squamiferum* J.J. Smith, Nova Guinea 14, 3 (1929) 468. — Type: Pulle s.n. (Franssen & Herderchee exp.) (BO).

*Bulbophyllum solutisepalum* J.J. Smith, Nova Guinea 14, 3 (1929) 470. — Type: Branderhorst, cult. BO 293 (BO).

Non *Bulbophyllum macgregorii* Ames, Philipp. J. Sc., Bot. 7 (1912) 137 (= *B. exquisitum* Ames, sect. *Monilibulbus*).

*Rhizome* creeping, 1.5–5 mm diam.; all rhizome scales slightly shorter to longer than the internodes. *Roots* in tufts below each pseudobulb. *Pseudobulbs* ovoid, 3–15 cm apart, 0.7–2.2 by 0.5–2.5 cm, not laterally flattened. *Petiole* 7–30 mm. *Leaf blade* ovate to elliptic, 4–14 by 0.9–4 cm, index 2.3–14, tip acute to acuminate. *Inflorescence* 10–39 cm, 2–40-flowered. *Peduncle* 9–21 cm; bracts 5–8, the longest 5–10 mm. *Rachis* approx. pendulous, 1–21 cm. *Floral bracts* triangular, 3–7 mm, tip acute. *Pedicel and ovary* 5.5–12 mm, with the node 0.5–1.5 mm from the floral bract. *Flowers* many open at the time, moderately opening. *Median sepal* with two folds along the midvein near the base, ovate to triangular, 12–26 by 3–6 mm, index 3.3–6.5, tip acute to acuminate; rather thin, often thickened towards the tip; glabrous. *Lateral sepals* connate or free, oblique, ovate to triangular, 18–46 by 3–8 mm, index 4.3–8, tip acute to acuminate; rather thin; glabrous. *Petals* ovate to elliptic, 2.5–7 by 1.5–3.5 mm, index 1.6–2.1, tip obtuse to acute; thin; glabrous. *Lip* curved, general outline ovate to subpanduriform, 1.4–3 by 0.8–1.8 mm, index 1.4–2 (not spread); tip rounded; margins glabrous or very finely papillose to ciliate; thick; surface approx. glabrous or slightly papillose locally; adx. concave near the base, with an inconspicuous to distinct median ridge, with 2 more ridges converging in front approx. half-way, abx. with a retuse median ridge. *Column* from ovary to the tip of the stelia 1–2 mm; stigma with a distinct tooth at its base, approx. sickle-shaped; column-foot approx. without accessories. *Stelidia* (obliquely) truncate. *Anther* abx. with a ridge towards its base; front margin protruding. *Pollinia* rarely 2, usually 4; the inner pair less than half as long as the outer pair.

*Colours* – Leaves often glaucous, or suffused with purple. Flowers pale yellowish to yellowish green. Lateral sepals sometimes suffused with purple, or entirely purple.

*Ecology* – Epiphyte in primary forest. Also found in rubber plantations. Alt. 0–2000 m asl. Flowering 1–3, 7, 10, 11.

*Distribution* – INDONESIA & PAPUA NEW GUINEA. New Guinea (widespread in Papua, in-

cluding the southern lowlands); New Ireland. — SOLOMON ISLANDS. (?)New Georgia (Chaplin 815, sterile, this species, or possibly *Bulbophyllum callichroma*).

Notes — 1. Differs from *Bulbophyllum callichroma* in the small median ridge on the adaxial side of the lip, near its base. Besides, the lateral sepals tend to be narrower. The lip often has finely papillose or ciliolate margins, a feature not found in *B. callichroma*.

2. Specimens of *Bulbophyllum chloranthum* with free lateral sepals differ from *B. levatii* in having larger flowers, wider sepals, a median ridge on the adaxial side of the lip, and in having 4 pollinia.

3. *Bulbophyllum chloranthum* is variable, in particular in the length of the sepals as well as in the glabrous/papillose/ciliolate margins of the lip.

4. The occurrence of both states: lateral sepals free/connate causes large differences in general appearance in specimens of *Bulbophyllum chloranthum*. Plants with free lateral sepals tend to have slightly narrower leaves and slightly longer pedicels. In general, the distribution of the states: lateral sepals free/connate only imperfectly coincides with the distribution of other character states, such as those mentioned in note 3. Distinction of infraspecific taxa is therefore not justified.

5. The identity of *Bulbophyllum arcuatum* is not entirely certain. It can hardly fail to be either *B. callichroma*, or *B. chloranthum*. The median ridge on the lip, which is characteristic for the latter, though sometimes inconspicuous, is not mentioned in the original description. However, it speaks of a lip with finely papillose margins. This character occurs only in *B. chloranthum*, and therefore *B. arcuatum* has been included here.

## 29. *Bulbophyllum dekokkii* J.J. Smith — Fig. 55.

*Bulbophyllum dekokkii* J.J. Smith, Bull. Jard. Bot. Buitenzorg II, 2 (1911) 17; Nova Guinea 12, 1 (1913) 92. — Type: De Kock XII (BO).

*Bulbophyllum jugicola* P. Royen, Alpine Fl. New Guinea 2 (1979) 175. — Type: Brass 9247 (AMES, BO, L).

*Rhizome* creeping or partly pendulous, 0.4–2 mm diam.; rhizome scales of the longest internodes distinctly shorter than those internodes, leaving bare large portions of the rhizome. *Roots* in tufts below most pseudobulbs. *Pseudobulbs* orbicular to ovoid, 1–8.5 cm apart, 0.3–1.4 by 0.2–1 cm, not flattened. *Petiole* 1–9 mm. *Leaf blade* ovate to elliptic, 0.8–4.5 by 0.6–2.4 cm, index 1.2–3, tip obtuse to acuminate. *Inflorescence* 2.5–7 cm, 1–6-flowered. *Peduncle* 1–3 cm; bracts c. 3, the longest 3–4 mm. *Rachis* approx. erect, up to 4 cm. *Floral bracts* ovate, 2–3 mm, tip acute. *Pedicel and ovary* 3–5.5 mm, with the node 1–1.5 mm from the floral bract. *Flowers* all open at the time, moderately opening. *Median sepal* ovate, 9–18.5 by 2.5–3.6 mm, index 3.6–5, tip acute to long acuminate; rather thin; glabrous. *Lateral sepals* free, oblique, ovate to triangular, 10–18.5 by 2.5–4 mm, index 3.3–4.6, otherwise as the median sepal. *Petals* elliptic, 3–5 by 1.2–2 mm, index 1.6–3.3, tip obtuse to acute; thin; approx. glabrous. *Lip* curved, general outline ovate to elliptic, 3–4.5 by 1–2 mm, index 1.6–3 (not spread), tip obtuse to acute; thick but soft; glabrous; adx. concave near the base, with 2 inconspicuous to distinct ridges converging in front; abx. with an inconspicuous, retuse median ridge. *Column* from ovary to the tip of the stelia 0.7–1.5 mm; stigma protruding at its base, but only slightly protruding below the lower margin of the stelia; orbicular; column-foot without accessories. *Stelia*

inconspicuous, semicircular, tip rounded. *Anther* abx. with a ridge; front margin protruding. *Pollinia* 2.

Colours – Leaves yellowish to dark green, often suffused with purple. Flowers yellow or white, often suffused with purple, or entirely dark purple.

Ecology – Epiphyte in forest and open woodland. Also found as a lithophyte in grassland on mossy limestone rocks. Alt. 2900–3300 m asl. Flowering observed in 1, 2, 4, 8.

Distribution – INDONESIA & PAPUA NEW GUINEA. New Guinea (central mountain range from Sudirman Ra. to Owen Stanley Ra. Also Huon Peninsula).

Notes – 1. Vegetatively recognizable by the thick, wide pseudobulbs and leaves. The flowers are characterized by the very short stigmatic opening. Its lower margin protrudes only just beyond the lower margins of the stelidia. In other species of sect. *Macrouris* the stigma extends much further down on the column-foot.

2. *Bulbophyllum decockii* shows extensive variability in the size of the vegetative parts: LAE 67054 is distinctly smaller than the other specimens seen (see Fig. 55), but otherwise (e.g. the size of the floral parts) not different.

### 30. *Bulbophyllum dendrochiloides* Schltr. – Fig. 56.

*Bulbophyllum dendrochiloides* Schltr., Fedde, Rep. Beih. 1 (1913) 871; 21 (1928) f. 1168. — Type: Schlechter 18237 (holo B, †; iso K).

*Rhizome* creeping but with the most recently developed parts usually patent or pendulous, 0.5–1.8 mm diam.; rhizome scales of the longest internodes distinctly shorter than those internodes, leaving bare large portions of the rhizome. *Roots* in tufts below most pseudobulbs. *Pseudobulbs* ovoid to cylindrical, 0.8–4 cm apart, 0.5–1.1 by 0.15–0.3 cm, not or hardly flattened. *Petiole* 2–7 mm. *Leaf blade* approx. elliptic, 2–6.5 by 0.4–0.7 cm, index 4.2–14, tip obtuse to acute. *Inflorescence* 5.5–16 cm, 10–35-flowered. *Peduncle* 4–8.5 cm; bracts 4–5, the longest 5–6 mm. *Rachis* erect, 2–6 cm. *Floral bracts* ovate to triangular, 1.2–3 mm, tip acute. *Pedicel and ovary* 2.5–5.5 mm, with the node 0.2–0.5 mm from the floral bract. *Flowers* many open at the time, moderately opening. *Median sepal* ovate to triangular, 2.8–6 by 0.7–1.2 mm, index 3.5–7.5, tip obtuse to long acuminate; rather thin; glabrous. *Lateral sepals* free, 3–7.5 by 0.5–1.3 mm, index 4–7.5, otherwise as the median sepal. *Petals* oblique, ovate to elliptic, 0.7–1.5 by 0.3–0.6 mm, index 1.7–3.8, tip obtuse to acute; margins glabrous to coarsely erose; thin; surface glabrous. *Lip* slightly curved, general outline ovate, divided into a basal part which is semi-circular or semi-elliptic in lateral view and which can be spread out easily, and a narrow top part, 1.2–1.8 by 0.4–0.6 mm, index 2.8–3.6 (not spread), tip obtuse to acute; rather thin and solid; approx. glabrous; adx. distinctly concave in the basal part, with 2 inconspicuous ridges converging in front approx. half-way; abx. approx. without a median ridge. *Column* from ovary to the tip of the stelidia 0.4–0.7 mm; stigma protruding at its base, approx. elliptic; column-foot without accessories. *Stelidia* inconspicuous, triangular, tip acute; upper margin often erose. *Anther* abx. with a ridge; front margin protruding. *Pollinia* 2.

Colours – Sepals and petals very pale greenish, yellowish or creamy white. Lip yellowish or greenish.

Ecology – Epiphyte in primary and secondary forest. Also found on isolated trees in grassland. Alt. 1000–2800 m asl. Flowering 1–3, 9–12.

Distribution – INDONESIA & PAPUA NEW GUINEA. New Guinea (central mountain range from Jayawijaya Ra. to Owen Stanley Ra. Also Saruwaged Mts).

Notes – 1. *Bulbophyllum dendrochiloides* can be confused easily with *B. phormion* and, to a lesser extent, with *B. oreodoxa*. The differences between the three are given under *B. phormion*.

2. Plants from high altitudes often have shorter pseudobulbs and leaves.

### 31. *Bulbophyllum fonsflorum* J.J. Vermeulen – Fig. 57.

*Bulbophyllum fonsflorum* J.J. Vermeulen, *Blumea* 34 (1990) 499. — Type: Reeve 598 (holo L, iso K, LAE).

*Rhizome* creeping, 1.8–2.5 mm diam.; all rhizome scales longer than the internodes. *Roots* in tufts below each pseudobulb. *Pseudobulbs* ovoid, 1–2 cm apart, 0.6–1.5 by 0.4–0.8 cm, not flattened. *Petiole* 25–40 mm. *Leaf blade* elliptic to obovate, 5.2–11 by 1.4–2.3 cm, index 3.5–6, tip acute to acuminate. *Inflorescence* 27–34 cm, 11–28-flowered. *Peduncle* 16–17 cm; bracts 4–5, the longest 7–9 mm. *Rachis* pendulous, 10–17 cm. *Floral bracts* ovate, 4–6 mm, tip acute to acuminate. *Pedicel and ovary* 9–20 mm, with the node c. 3 mm from the floral bract. *Flowers* many open at the time, moderately opening. *Median sepal* ovate, 55–85 by 5–7 mm, index 11–14, tip caudate; rather thin; glabrous. *Lateral sepals* free, oblique, 65–120 by 4–5.5 mm, index 17–30, otherwise as the median sepal. *Petals* oblique, 5.5–7 by 2.8–3.5 mm, index 2–2.2, tip obtuse to subacute; otherwise as the median sepal. *Lip* curved, general outline ovate, 5–6 by 2–2.5 mm, index c. 2.5 (not spread), tip rounded; rather thick; glabrous; adx. concave near the base, with 2 parallel ridges close to the midvein approx. half-way, abx. with a retuse median ridge. *Column* from ovary to the tip of the stolidia 1.2–1.5 mm; stigma protruding at its base, triangular, column-foot without accessories. *Stolidia* inconspicuous, tip rounded. *Anther* abx. with a very distinct ridge towards its tip; front margin not protruding. *Pollinia* 2.

Colours – Pseudobulbs brownish. Leaves green, often suffused with purple. Peduncle and rachis purple. Sepals and petals white, with purple veins. Lip creamy yellow, suffused with pinkish purple in the centre.

Ecology – Epiphyte in primary forest. Alt. 1800–2800 asl. Flowering 1, 2, 12.

Distribution – PAPUA NEW GUINEA. New Guinea (central mountain range: Western Highlands Prov.; Chimbu Prov.; Eastern Highlands Prov.).

Note – This species is mainly characterized by its very long sepals. Other diagnostic characters are the position of the keels on the adaxial side of the lip, as well as the very conspicuous ridge on the anther cap.

### 32. *Bulbophyllum graciliscapum* Schltr. – Fig. 58.

*Bulbophyllum graciliscapum* Schltr. in Schum. & Laut., *Nachtr.* (1905) 203; Fedde, *Rep. Beih.* 1 (1913) 872; 21 (1928) f. 1170. — Type: Schlechter 13924 (holo B, †; iso BM, K).

*Bulbophyllum setipes* Schltr., Fedde, *Rep. Beih.* 1 (1913) 869; 21 (1928) f. 1165. — Type: Schlechter 18798 (B, †).

Non *Bulbophyllum graciliscapum* Ames & Rolfe in Ames, *Orch.* 5 (1915) 175 (= sect. *Leptopus*); nec *B. graciliscapum* Perr., *Not. Syst.* 6 (1937) 107 (= sect. *Ploiarium*); nec *B. graciliscapum* Summerh., *Kew Bull.* 8 (1954) 579 [= *B. saltatorium* Lindl. var. *albociliatum* (Finet) J.J. Vermeulen].

*Rhizome* creeping, 0.6–1.2 mm diam.; rhizome scales of the longest internodes shorter than those internodes, leaving bare large portions of the rhizome. *Roots* in tufts below the pseudobulbs. *Pseudobulbs* ovoid, 1.5–5 cm apart, 0.3–0.8 by 0.2–0.7 cm, not flattened. *Petiole* 1–5 mm. *Leaf blade* elliptic, 1.8–6.2 by 0.3–1.1 cm, index 2.5–8, tip acute. *Inflorescence* 5–26 cm, up to 42-flowered. *Peduncle* 2.5–18 cm, bracts 4, the longest 2–2.5 mm. *Rachis* erect to arching, up to 10 cm. *Floral bracts* triangular, 1–1.8 mm, tip acute. *Pedicel and ovary* 4–7 mm, with the node 0.8–1.5 mm from the floral bract; ovary glabrous. *Flowers* 1 or few open at the time, moderately opening. *Median sepal* ovate to triangular, 2.2–4.2 by 1.3–2 mm, index 1.2–2, tip acute to acuminate or apiculate; thin; glabrous. *Lateral sepals* oblique, 2.7–4.2 by 1.2–2.3 mm, index 1.9–2.5, tip acute; otherwise as the median sepal. *Petals* oblique, elliptic to obovate, 1–1.8 by 0.6–1.7 mm, index 1–2.5, tip rounded to acute; margins glabrous to distinctly denticulate; thin; surface glabrous. *Lip* approx. straight or slightly curved at the base, general outline distinctly ovate, 1.4–2.2 by 0.7–1.3 mm, index 1.6–2 (not spread), tip obtuse to subacute; margins glabrous or finely papillose; thick; surface glabrous; adx. concave towards the base, with an inconspicuous to distinct median ridge, with 2 distinct ridges converging in front and sometimes approx. fused in the top half of the lip; abx. with a distinct, retuse median ridge. *Column* from ovary to the tip of the stelia 0.6–1 mm; stigma protruding at its base, transversely elliptic; column-foot without accessories. *Stelidia* inconspicuous, triangular, tip acute, upper margin erose, with an inconspicuous to distinct, small, deltoid obtuse to acute tooth along the lower margin. *Anther* abx. with a ridge towards its base; front margin not protruding. *Pollinia* 2.

Colours – Plant medium green. Sepals and petals yellow, with purple veins, or entirely purple with or without a whitish base. Lip greenish or purple.

Ecology – Epiphyte in primary forest. Alt. 0–1100 m asl. in the Solomon Isl. and Vanuatu; up to 2300 m asl. in Papua New Guinea. Flowering 1, 9–11.

Distribution – PAPUA NEW GUINEA. New Guinea (central mountain range: Western Highlands Prov.). – SOLOMON ISLANDS. Rendova; Malaita. – VANUATU. Banks Isl.; Espiritu Santo; Erromango; Pentecost; Anatom.

Note – This species is similar to *Bulbophyllum orbiculare*. It can be distinguished by its distinctly ovate lip with approx. glabrous margins. Occasionally specimens of *B. orbiculare* occur which also have a lip with glabrous margins. Such specimens either do not have a distinctly ovate lip, or have a lip with a distinctly curved tip. An example of such a lip has been added to Fig. 58 of *B. graciliscapum*.

### 33. *Bulbophyllum kaniense* Schltr. – Fig. 59.

*Bulbophyllum kaniense* Schltr., Fedde, Rep. Beih. 1 (1913) 867; 21 (1928) f. 1161. — Syntypes: Schlechter 16967 (lecto B, †; isolecto BM, K), 19007 (B, †; BM, K).

*Bulbophyllum dispersum* Schltr., Fedde, Rep. Beih. 1 (1913) 867; 21 (1928) f. 1160. — Syntypes: Schlechter 15244 & 17151 (both B, †).

*Bulbophyllum dispersum* Schltr. var. *roseans* Schltr., Fedde, Rep. Beih. 1 (1913) 867. — Type: Schlechter 20281 (B, †).

*Bulbophyllum extensum* Schltr., Fedde, Rep. Beih. 1 (1913) 868; 21 (1928) f. 1162. — Type: Schlechter 20299 (B, †).

*Rhizome* creeping but with the most recently developed parts usually patent or pendulous, 0.8–1.2 mm diam.; rhizome scales of the longest internodes distinctly shorter than those internodes, leaving bare large portions of the rhizome. *Roots* in tufts below most pseudobulbs. *Pseudobulbs* ovoid, 0.8–6.5 cm apart, 0.5–1.2 by 0.1–0.4 cm, not flattened. *Petiole* 1–5 mm. *Leaf blade* generally ovate, also elliptic, 1.3–7 by 0.3–1.7 cm, index 2–9, tip acute to acuminate. *Inflorescence* 1.2–3 cm, 3–10-flowered. *Peduncle* 0.5–1.2 cm; bracts 3–4, the longest 3–5 mm. *Rachis* erect, 0.4–1 cm. *Floral bracts* triangular, 2.4–3 mm, tip acute. *Pedicel and ovary* 2.8–4.5 mm, with the node 0.4–1 mm from the floral bract. *Flowers* all open at the time, moderately opening. *Median sepal* ovate to elliptic, 8–17 by 1.2–2 mm, index 4.5–14, tip acuminate to caudate; thin; glabrous. *Lateral sepals* free, oblique, ovate, 8–25 by 1.2–2.2 mm, index 4.1–16, otherwise as the median sepal. *Petals* (ob)ovate to elliptic, 1.4–2.8 by 0.5–1.4 mm, index 2–3.3, tip (sub)acute; margins glabrous to slightly erose; thin; surface glabrous. *Lip* curved, general outline ovate, 1.3–3 by 0.7–1.3 mm, index 1.8–2.5 (not spread), tip rounded; thick but soft; glabrous; adx. concave near the base; abx. with an inconspicuous, truncate median ridge. *Column* from ovary to the tip of the stielidia 0.5–0.8 mm; stigma protruding at its base, obovate; column-foot without accessories. *Stielidia* inconspicuous, triangular, tip acute. *Anther* abx. with a ridge; front margin protruding. *Pollinia* 2.

Colours – Sepals and petals white or yellowish, sometimes with some pink. Lip yellow or white.

Ecology – Epiphyte in primary forest. Alt. 800–1100 m asl. Flowering observed in 1, 9, 12.

Distribution – PAPUA NEW GUINEA. New Guinea (mountain ranges N of Sepik R.; Finisterre Mts; Saruwaged Mts).

Notes – 1. *Bulbophyllum oreodoxa* differs in having entirely creeping rhizomes and much longer inflorescences; *B. trifilum* has entirely patent rhizomes, only attached at the substratum at their very base.

2. In some specimens the sepals are acuminate, in others long-caudate.

### 34. *Bulbophyllum levatii* Kränzlin

Literature: see under the subspecies.

*Rhizome* creeping, 1–4 mm diam.; all rhizome scales slightly shorter or longer than the internodes. *Roots* in tufts below each pseudobulb. *Pseudobulbs* ovoid, 1.4–7 cm apart, 0.4–2 by 0.3–1 cm, not flattened. *Petiole* 4–30 mm. *Leaf blade* elliptic to obovate, 3–11 by 0.6–3 cm, index 2.2–5.3, tip obtuse to acute. *Inflorescence* 6–35 cm, 4–55-flowered. *Peduncle* 4.5–17 cm; bracts 4–6, the longest 3–7 mm. *Rachis* erect to pendulous, 1.5–21 cm. *Floral bracts* triangular, 1.5–4 mm, tip acute to acuminate. *Pedicel and ovary* 6.5–14 mm, with the node 0.5–1.5 mm from the floral bract. *Flowers* many open at the time, moderately opening. *Median sepal* ovate, 8–30 by 1.1–2.8 mm, index 4–17, tip long acuminate to caudate; rather thin; glabrous. *Lateral sepals* free, oblique, ovate to triangular, 8–34 by 1.2–3.2 mm, index 3.4–16, otherwise as the median sepal. *Petals* ovate to elliptic, 1.3–3 by 0.7–1.8 mm, index 1.5–2.5, tip rounded to acute; margins glabrous to erose; thin; surface glabrous. *Lip* somewhat curved, general outline ovate, 1.3–2.5 by 0.8–1.5 mm, index 1.5–2.8 (not spread), tip rounded; thick; approx. glabrous; adx. concave near

the base, with 2 ridges converging in front; abx. with a retuse median ridge. *Column* from ovary to the tip of the stielidia 0.6–1.5 mm; stigma protruding at its base, approx. orbicular; column-foot approx. without accessories. *Stielidia* inconspicuous, triangular, tip acute; with a distinct, generally forwards directed, deltoid or triangular, rounded to acute tooth along the lower margin. *Anther* abx. with a ridge; front margin protruding. *Pollinia* 2.

Notes – 1. The differences from *Bulbophyllum chloranthum* as well as *B. oreodoxa* are given under those species.

2. Mainly on account of the length as well as the index of the lateral sepals two subspecies can be distinguished in *Bulbophyllum levatii*. Geographically the two are entirely separated, although the gap between the two may represent either true absence or insufficient collecting.

#### KEY TO THE SUBSPECIES

- 1a. Lateral sepals 8–20 mm long, index 3.4–8. Petals 1.8–3 mm long  
a. subsp. *levatii*
- b. Lateral sepals (12–)16–34 mm long, index 9–16. Petals 1.3–2.2 mm long  
b. subsp. *mischanthum*

a. subsp. *levatii* – Fig. 60.

*Bulbophyllum levatii* Kränzlin, Bull. Soc. Bot. Fr. 76 (1929) 300. — Type: Levat s.n. (not seen).

*Rhizome scales* often slightly shorter than the internodes. *Inflorescence* 6–14 cm long, 4–12-flowered. *Median sepal* 8–18 by 1.6–2.8 mm. *Lateral sepals* 8–20 by 2–3.2 mm, index 3.4–8. *Petals* 1.8–3 mm long.

Colours – Peduncle and rachis reddish purple. Pedicel green, ovary ochre. Flowers usually entirely white, sepals sometimes stained with purple or purple with a white tip; lip white, pink or purple.

Ecology – Epiphyte in primary forest. Alt. 100–1400 m asl. Flowering 3–10.

Distribution – SOLOMON ISLANDS. Guadalcanal. – VANUATU. Ambae; Efate; Erromango; Espiritu Santo; Pentecost.

Notes – 1. The differences from *Bulbophyllum chloranthum* are mentioned under the latter species.

2. The specimen Cribb et al. 5047, the only one from the Solomon Islands and therefore geographically closest to subsp. *mischanthum*, has sepals somewhat longer (but certainly not narrower) than usual in subsp. *levatii*. In this respect it somewhat approaches subsp. *mischanthum*.

b. subsp. *mischanthum* J.J. Vermeulen, *subsp. nov.* – Fig. 61; Plate 3a.

*Bulbophyllum levatii* subsp. *mischanthum* a subsp. typica a sepalis lateralibus longioribus angustioribusque distinguendum. — Typus: Jongejan 249 (L).

*Rhizome scales* generally longer than the internodes. *Inflorescence* 11–35 cm long, 6–55-flowered. *Median sepal* (10–)15–30 by 1.1–2 mm. *Lateral sepals* (12–)16–34 by 1.2–2.2 mm, index 9–16. *Petals* 1.3–2.2 mm long.



Colours – Sepals white to greenish yellow, either or not suffused with pink or purple towards the tip or the base. Petals white, with or without purple vein. Lip (creamy) white.

Ecology – Epiphyte in primary or secondary forest. Occasionally as a lithophyte. Alt. 900–1900 m asl. Flowering observed in 1, 3, 4, 8, 9.

Distribution – PAPUA NEW GUINEA. New Guinea (central mountain range from Mt Capella to Milne Bay Prov. Also mountain ranges N of Sepik R.).

Notes – 1. Differs from *Bulbophyllum levatii* subsp. *levatii* mainly in having longer and narrower sepals.

2. The name refers to the long-stalked flowers: the Greek 'mischos' means stalk, and 'anthos' flower.

### 35. *Bulbophyllum macrourum* Schltr. – Fig. 62.

*Bulbophyllum macrourum* Schltr. in Schum. & Laut., Nachtr. (1905) 207; Fedde, Rep. Beih. 1 (1913) 866; 21 (1928) f. 1158. — Type: Schlechter 15744 (B, †). Neotype: Schlechter 17016 (AMES, BM, BO, K, L).

*Bulbophyllum pensile* Schltr., Fedde, Rep. Beih. 1 (1913) 866; 21 (1928) f. 1159. — Type: Schlechter 19895 (holo B, †; iso BO, L).

*Rhizome* perpendicularly hanging down, up to 45 cm long, sometimes winged, largest diam. 0.6–1.2 mm; rhizome portion between two pseudobulbs usually with a node at 1/4 to 1/2 of its length; rhizome scales of the longest internodes distinctly shorter than those internodes, leaving bare large portions of the rhizome. *Roots* often all close to the base of the rhizome. *Pseudobulbs* approx. cylindrical, 1–5 cm apart, 0.3–0.9 by 0.1–0.3 cm, often somewhat flattened. *Petiole* 0.7–2 mm. *Leaf blade* ovate to elliptic, 1.5–5.6 by 0.8–2.8 cm, index 1.5–3.2, tip acuminate. *Inflorescence* 3.8–10 cm, 3–9-flowered. *Peduncle* 1.8–3.5 cm; bracts 3, the longest 4–7 mm. *Rachis* pendulous, 0.8–4 cm. *Floral bracts* ovate to triangular, 1.5–4 mm, tip acute. *Pedicel and ovary* 5–10 mm, with the node 1–2 mm from the floral bract. *Flowers* many open at the time, moderately opening. *Median sepal* ovate, 9–30 by 1.8–3.2 mm, index 4–10, tip long acuminate to caudate; thin; glabrous. *Lateral sepals* free, oblique, ovate to triangular, 12–37 by 2–4 mm, otherwise as the median sepal. *Petals* ovate to elliptic, 2.2–4 by 1–2 mm, index 1.9–2.5, tip obtuse to acute; thin; glabrous. *Lip* curved, general outline ovate to elliptic, in lateral view approx. equally high up to, or over half-way its length, 2.5–4 by 1.5–2 mm, index 1.6–2 (not spread), tip rounded; thick but soft; glabrous; adx. concave near the base, often with 2 inconspicuous ridges close to the margins approx. half-way; abx. with an inconspicuous, a retuse median ridge. *Column* from ovary to the tip of the stelia 0.9–1.5 mm; stigma protruding at its base, triangular, column-foot without accessories. *Stelia* inconspicuous, triangular, tip acute. *Anther* abx. with a ridge; front margin protruding. *Pollinia* 2.

Colours – Leaves often suffused with purple. Sepals and petals pale green, yellowish or white. Lip white or cream-coloured, sometimes with a purple blotch in the centre.

Ecology – Epiphyte in primary forest. Also found in secondary forest, and on trees in gardens. Alt. 800–2000 m asl. Flowering observed in 1, 4, 6, 8, 10, 12.

Distribution – PAPUA NEW GUINEA. New Guinea (central mountain range from Western Highlands Prov. to Milne Bay Prov. Also mountain ranges N of Sepik R.; Finisterre Mts; Saruwaged Mts).

Notes – 1. Similar to *Bulbophyllum cateorum* as well as *B. trifilum*; the differences are given under those respective species.

2. The length of the sepals shows some variability. *Bulbophyllum macrourum* was founded on a specimen with comparatively long sepals; *B. pensile* on a specimen with short sepals. Otherwise the two are not different, and intermediates exist.

3. Schlechter's drawing of *Bulbophyllum pensile* shows 4 pollinia. In an isotype specimen in L only 2 pollinia are present. Possibly Schlechter made a mistake here.

### 36. *Bulbophyllum mulderae* J.J. Vermeulen, *spec. nov.* – Fig. 63.

*Bulbophyllum mulderae* *B. cateoro* simile, sed minore in partibus omnibus et stigmati basi protuberatione angulata in aspectu laterali differt. — Typus: Leiden cult. 31482 (L).

*Rhizome* hanging down perpendicularly, up to 35 cm long, flattened and winged, largest diam. 0.4–0.6 mm; rhizome portion between two pseudobulbs without a node approx. half-way; rhizome scales of the longest internodes distinctly shorter than those internodes, leaving bare large portions of the rhizome. *Roots* generally close to the base of the rhizome. *Pseudobulbs* cylindrical, 0.5–1.8 cm apart, 0.2–0.3 by 0.08–0.1 cm, not flattened. *Petiole* 0.5–1 mm. *Leaf blade* ovate to elliptic, or orbicular, 0.5–1.3 by 0.5–1.2 cm, index 1–1.5, tip finely acuminate. *Inflorescence* 1–1.5 cm, 1- or 2-flowered. *Peduncle* 0.3–0.5 cm; bracts 2, the longest c. 2 mm. *Rachis* if present 0.01–0.1 cm. *Floral bracts* triangular, c. 2 mm, tip acuminate. *Pedicel and ovary* c. 4 mm, with the node 1–1.2 mm from the floral bract. *Flowers* all open at the time, moderately opening. *Median sepal* ovate, 13–15 by 2.5 mm, index 5–6; tip long acuminate to caudate; thin; glabrous. *Lateral sepals* free, oblique, triangular, 14–15 by 3 mm, index 4–5, otherwise as the median sepal. *Petals* ovate to elliptic, c. 4 by 1.8 mm, index c. 2.2, tip approx. acute; thin; glabrous. *Lip* curved, general outline ovate, in lateral view highest near the base, c. 3.8 by 1.5 mm, index c. 2.5 (not spread), tip obtuse; thick but soft; glabrous; adx. concave near the base; abx. with an inconspicuous, retuse median ridge. *Column* from ovary to the tip of the stielidia c. 0.8; stigma protruding at its base (base of stigma angular in lateral view), approx. triangular; column-foot approx. without accessories. *Stielidia* inconspicuous, triangular, tip acute; with a small, approx. subacute tooth along the upper margin. *Anther* abx. with a ridge towards its tip; front margin hardly protruding. *Pollinia* 2.

Colours – Leaves often tinged purplish, somewhat glaucous abaxially. Flowers white.

Ecology – Epiphyte in (disturbed) primary forest. Alt. 1500–2000 m asl. Flowering observed in 12 in European greenhouse.

Distribution – INDONESIA & PAPUA NEW GUINEA. New Guinea (central mountain range: Sudirman Ra.; Southern Highlands Prov.).

Notes – 1. *Bulbophyllum cateorum* differs in being larger in all parts, and in having the protruding base of the stigma rounded in lateral view. When more material becomes available, the differences between the two species should be re-evaluated.

2. Named after Mrs. T. Mulder-Roelfsema (Wageningen, The Netherlands).

### 37. *Bulbophyllum muscicola* Schltr. – Fig. 64; Plate 3b.

*Bulbophyllum muscicola* Schltr., Fedde, Rep. Beih. 1 (May 1st, 1913) 870; 21 (1928) f. 1166. — Type: Schlechter 20241 (B, †). Neotype: Carr 10252 (AMES, CANB, K, NY).

*Bulbophyllum equivestigium* Gilli, Ann. Nat. Mus. Wien 84 (1983) 16. — Type: Gilli 566 (not seen). Non *Bulbophyllum muscicola* Schltr., Ann. Mus. Col. Marseille III, 1 (1913, exact date not traceable) 36 (= sect. *Trichopus* from Madagascar).

*Rhizome* creeping, 0.8–2 mm diam.; all rhizome scales shorter to slightly longer than the internodes. *Roots* in tufts below each pseudobulb. *Pseudobulbs* ovoid to orbicular or lenticular, 0.5–2.5 cm apart, 0.3–1 by 0.2–1 cm, not laterally flattened. *Petiole* 1–6 mm. *Leaf blade* ovate to elliptic, 0.6–4.1 by 0.4–1.7 cm, index 1.2–7.2, tip acute. *Inflorescence* 1.9–20 cm, 2–16-flowered. *Peduncle* 3.5–14 cm, bracts 3–4, the longest 2–4.5 mm. *Rachis* erect or arching, 0.2–6 cm. *Floral bracts* ovate, 1.8–2.5 mm, tip acute. *Pedicel and ovary* 2–10 mm, with the node 0.4–2 mm from the floral bract; ovary glabrous. *Flowers* all open at the time, widely opening. *Median sepal* ovate to elliptic, 4–11 by 1.8–6 mm, index 1.2–3, tip retuse to acuminate; thin; glabrous. *Lateral sepals* oblique, triangular to elliptic, 4–12 by 2–5.5 mm, index 1.3–3, tip obtuse to acuminate; otherwise as the median sepal. *Petals* oblique, elliptic to obovate, 2.8–5 by 1–4 mm, index 1–2.8, tip emarginate to subacute; margins glabrous or somewhat erose; thin; surface glabrous. *Lip* distinctly curved, general outline ovate to approx. orbicular, 1.5–3.2 by 1.5–3 mm, index 1–1.3 (not spread), tip obtuse to acute; rather thick but soft; glabrous; adx. moderately concave towards the base, sometimes with 2 inconspicuous ridges approx. half-way; abx. with a distinct, retuse median ridge. *Column* from ovary to the tip of the stelia 0.8–1.5 mm; stigma with a distinct tooth at its base, narrowly elliptic or slit-like; column-foot without accessories. *Stelidia* inconspicuous, triangular, tip acute; upper margin sometimes erose, sometimes with an inconspicuous, small, deltoid, rounded to acute wing along the lower margin. *Anther* abx. with an inconspicuous ridge towards its base; front margin not protruding. *Pollinia* 2.

*Colours* – Plants often suffused with purple. Sepals and petals whitish or yellow, usually with purple veins; sometimes entirely suffused with pinkish purple. Lip yellow, usually with a purple streak along the median line, or suffused with purple, or entirely dark purple.

*Ecology* – Epiphyte in primary forest. Also in secondary vegetation. Sometimes as a terrestrial among moss. Alt. 1500–2700 m asl. Flowering 1, 9–12.

*Distribution* – INDONESIA & PAPUA NEW GUINEA. New Guinea (widespread in Papua though not in the southern lowlands; Jayawijaya Ra.); Goodenough Islands.

*Notes* – 1. Specimens with a relatively short median sepal differ from other species with such a median sepal by the soft, spongy lip. Specimens with a long and narrow median sepal may approach *Bulbophyllum oreodoxa*, but differ in having a tooth at the base of the stigma.

2. Extensive variability occurs in the size of the vegetative and floral parts, in the number of flowers per inflorescence, as well as in the shape and the index of the sepals and the petals. However, all extreme forms are linked by abundant intermediate specimens. Distinction of subspecies is therefore not possible.

3. The type of *Bulbophyllum muscicola* is lost. The name applies to a plant which, according to Schlechter's description and illustrations, shows the specific characters, but is smaller than the smallest specimen studied by the present author. The specimen Carr 10252 has been appointed neotype, because this closest approaches Schlechter's description of the holotype.

4. *Bulbophyllum microsphaerum* Schltr., Fedde, Rep. Beih. 1 (1913) 791, has flowers which, in shape, fit into *B. muscicola*. It differs only in having the pseudobulbs distinctly

more spaced (compared to specimens of *B. muscicola* of similar size) and in having a 1-flowered inflorescence. It is not included here into *B. muscicola*, but regarded as a separate species fitting into sect. *Nematorhizis*.

5. The exact date of publication of *Bulbophyllum muscicola* Schltr. from Madagascar (see above) could not be traced. If this taxon proves to be published earlier than the New Guinean *B. muscicola*, the latter name should be replaced by the junior synonym *equi-vestigium*.

### 38. *Bulbophyllum myon* J.J. Vermeulen – Fig. 65; Plate 3c.

*Bulbophyllum myon* J.J. Vermeulen, Blumea 34 (1990) 501. — Type: Jongejan 1388 (holo L, iso K).

*Rhizome* hanging down, often perpendicularly so, up to 80 cm long, somewhat flattened and winged, largest diam. 0.6–1.2 mm; rhizome scales of the longest internodes distinctly shorter than those internodes, leaving bare large portions of the rhizome. *Roots* generally close to the base of the rhizome. *Pseudobulbs* ovoid to approx. cylindrical, 1.8–6.5 cm apart, 0.8–2 by 0.2–0.3 cm, not flattened. *Petiole* 1–3 mm. *Leaf blade* ovate, 2.5–10.8 by 0.3–0.9 cm, index 4.5–21, tip acute-acuminate. *Inflorescence* 2–10 cm, 2–8-flowered. *Peduncle* 3.5–5 cm; bracts c. 3, the longest 4–5 mm. *Rachis* pendulous, 0.7–5 cm. *Floral bracts* ovate, 1.2–2 mm, acute. *Pedicel and ovary* 4–6 mm, with the node 1–2 mm from the floral bract. *Flowers* all open at the time, moderately opening. *Median sepal* ovate, 7.5–12 by 3.8–4.5 mm, index 1.9–3.2, tip (sub)acute; margins finely papillose-ciliolate; thin; surface glabrous. *Lateral sepals* connate, 9–14 by 2.8–3.5 mm, index 2.8–5, margins glabrous or slightly papillose; otherwise as the median sepal. *Petals* ovate to elliptic, 2.6–4 by 1.8–2.2 mm, index 1.5–2, tip rounded to obtuse; margins glabrous to somewhat erose; thin; surface glabrous. *Lip* approx. straight, general outline ovate, 2.6–3 by 1.2–1.3 mm, index 2–2.3, (not spread), tip rounded; thick but soft; glabrous; adx. concave near the base, with 2 ridges converging in front approx. half-way; abx. with an inconspicuous, retuse median ridge. *Column* from ovary to the tip of the stelia 1.2–1.8 mm; stigma protruding at its base, elliptic, column-foot without accessories. *Stelia* inconspicuous, deltoid, tip obtuse to acute; often with an erose upper margin. *Anther* abx. with a ridge, front margin protruding. *Pollinia* 2.

*Colours* – Sepals (creamy) yellow, often with purple veins and the tip entirely purple. Petals cream coloured, often with a purple vein. Lip yellowish, often suffused with purple.

*Ecology* – Epiphyte in (disturbed) primary forest. Alt. 1800–3000 m asl. Flowering observed in 1–3, 5, 9–12.

*Distribution* – INDONESIA & PAPUA NEW GUINEA. New Guinea (central mountain range: Sudirman Ra.; Western Highlands Prov. to Wharton Ra.).

*Note* – Among the species of section *Macrouris* with connate lateral sepals this species is at once recognizable by its thin, entirely pendulous rhizomes.

### 39. *Bulbophyllum olivinum* J.J. Smith

*Literature*: see under the subspecies.

*Rhizome* creeping, 2–9 mm diam.; all rhizome scales slightly shorter to longer than the internodes. *Roots* in tufts below each pseudobulb. *Pseudobulbs* ovoid to orbicular, some-

times slightly lenticular, 2–9 cm apart, 1–3.5 by 0.6–1.8 cm, not laterally flattened. *Petiole* 8–45 mm. *Leaf blade* ovate to elliptic, 5.5–12 by 1.5–4 cm, index 2–6, tip obtuse to acute. *Inflorescence* 33–72 cm, 15–55-flowered. *Peduncle* 24–56 cm, bracts 5–8, the longest 7–12 mm. *Rachis* erect or arching, 4–16 cm. *Floral bracts* ovate, 3–8 mm, tip acute. *Pedicel and ovary* 10–15 mm, with the node 1.5–2.5 mm from the floral bract; ovary glabrous. *Flowers* few or many open at the time, widely opening. *Median sepal* ovate to elliptic, 6.5–10 by 3.5–6 mm, index 1.2–2.2, tip obtuse to shortly acuminate or apiculate; rather thin; glabrous. *Lateral sepals* oblique, 8–14 by 3.5–5.5 mm, index 1.6–2.6, tip obtuse to acute; otherwise as the median sepal. *Petals* oblique, approx. elliptic, 2.8–5 by 2–3.8 mm, index 1–1.6, tip obtuse to acute, or apiculate; margins glabrous or finely erose; thin; surface glabrous. *Lip* curved at the base, general outline approx. elliptic or spatulate, 2.8–5.5 by 1.5–2.5 mm, index 1.3–2.5 (not spread), tip rounded to acute; thick; glabrous; adx. concave near the base, with an inconspicuous to distinct median ridge which either bifurcates or is flanked by a shorter ridge on each side in the back, with 2 more distinct ridges converging and fused in front, in the basal half of the lip, into a median ridge; abx. with an inconspicuous, retuse median ridge. *Column* from ovary to the tip of the stolidia 1.2–1.8 mm; stigma with 3 distinct teeth at its base, orbicular; column-foot without accessories. *Stolidia* inconspicuous, triangular, tip obtuse to acute; upper margin erose; with a prominent, forwards pointing, triangular to semi-elliptic, rounded to acute tooth along the lower margin. *Anther* abx. with an inconspicuous ridge towards its base; front margin somewhat protruding. *Pollinia* 2.

Colours – Pseudobulbs often suffused with purple. Sepals and petals yellowish green to apple green, suffused with purple or not (in particular in the centre); or entirely purple, sometimes with a yellow midvein. Lip yellow, pink or purple.

Notes – 1. *Bulbophyllum graciliscapum* and *B. orbiculare* are much smaller in all parts. Further differences can be found in the configuration of the ridges on the adaxial side of the lip. In *B. olivinum* the three main ridges converge in front and are fused into a single, very distinct ridge in the basal half of the lip; in the other two species the ridges converge too, but are either not fused to a single ridge, or only so at the extreme tip of the lip.

2. In general this species does not show extreme variability. A few specimens, however, have a spatulate, not an elliptic, lip. Because they fit into the species in all other characters they are regarded as a subspecies.

#### KEY TO THE SUBSPECIES

- 1a. Lip approx. elliptic, 2.8–3.8 mm long, index 1.3–2 . . . . . a. subsp. *olivinum*
- b. Lip elliptic to distinctly spatulate, 4.5–5.5 mm long, index 2–2.5  
b. subsp. *linguiferum*

a. subsp. *olivinum* – Fig. 66a–i.

*Bulbophyllum olivinum* J.J. Smith, Bot. Jahrb. 66 (1934) 205. — Type: Stein 432 (not seen).

*Lip* approx. elliptic, 2.8–3.8 mm long, index 1.3–2.

Ecology – Epiphyte in primary forest and montane shrubbery. Alt. 1500–3000 m asl. Flowering 1–12.

Distribution – INDONESIA & PAPUA NEW GUINEA. New Guinea (central mountain range from Sudirman Ra. to Wharton Ra. Also Cendrawasih Peninsula).

**b. subsp. linguiferum** J.J. Vermeulen, *subsp. nov.* – Fig. 66j, k.

*Bulbophyllum olivinum* subsp. *linguiferum* a subsp. *typica* a labello manifeste spatulato distinctum. — Typus: NGF 22757 (Millar) (holo L, iso BRI, LAE).

*Lip* elliptic to distinctly spatulate, 4.5–5.5 mm long, index 2–2.5.

Ecology – Epiphyte in primary forest. Alt. 900–1700 m asl. Flowering observed in 9, 11.

Distribution – PAPUA NEW GUINEA. New Guinea (central mountain range: Wharton Ra.; Owen Stanley Ra.).

#### 40. *Bulbophyllum orbiculare* J.J. Smith

Literature: see under the subspecies.

*Rhizome* creeping, 0.8–2.5 mm diam.; all rhizome scales distinctly shorter to slightly longer than the internodes. *Roots* in tufts below each pseudobulb. *Pseudobulbs* ovoid to approx. 0.6–7 cm apart, 0.5–2 by 0.4–1.5 cm, not flattened. *Petiole* 3–30 mm. *Leaf blade* elliptic to approx. obovate, 2–12 by 0.3–1.4 cm, index 1.5–33, tip obtuse to acute. *Inflorescence* 3–32 cm, up to 30-flowered. *Peduncle* 2.5–22 cm, glabrous to coarsely verrucose; bracts 4–6, the longest 3–7 mm. *Rachis* erect to arching, up to 11 cm. *Floral bracts* ovate to elliptic, 2.5–9 mm, tip acute to acuminate. *Pedicel and ovary* 4.5–10 mm, with the node 1–3 mm from the floral bract; glabrous to verrucose. *Flowers* 1 to many open at the time, moderately to widely opening. *Median sepal* ovate to elliptic, 3–7.5 by 3–5 mm, index 0.9–1.8, tip emarginate to acute, or apiculate, margins glabrous or finely papillose towards the tip; rather thin; surface glabrous. *Lateral sepals* oblique, 3.8–8 by 1.5–3 mm, index 2–3.7, tip obtuse to acute, or apiculate; otherwise as the median sepal. *Petals* oblique, elliptic to obovate, 1.2–3 by 0.7–2.2 mm, index 1–1.6, tip emarginate to acuminate; margins glabrous, erose or finely papillose; thin; surface glabrous. *Lip* approx. straight to distinctly curved, general outline (ob)ovate to elliptic, sometimes very slightly ovate, 1.5–3.5 by 0.8–1.8 mm, index 1.2–3.4 (not spread), tip rounded to subacute; margins generally ciliate, sometimes glabrous or papillose; thick; surface approx. glabrous or somewhat papillose locally; adx. concave towards the base, with a distinct median ridge, with 2 more distinct ridges converging in front but fused into a median ridge or only so near the top of the lip; abx. with a distinct, retuse median ridge. *Column* from ovary to the tip of the stelia 0.9–1.8 mm; stigma protruding and generally with a distinct tooth at its base, approx. orbicular; column-foot without accessories. *Stelia* inconspicuous, triangular, tip obtuse to acute; upper margin often erose or denticulate, with or without an inconspicuous, deltoid, rounded, to acute tooth along the lower margin. *Anther* abx. with a ridge towards its base; front margin somewhat protruding. *Pollinia* 2.

Notes – 1. The differences between this species and *Bulbophyllum olivinum* and *B. graciliscapum* are mentioned under those respective species.

2. *Bulbophyllum orbiculare* shows extensive variability, in particular in the size of all parts. The inflorescence may be smooth to coarsely verrucose, with all the grades in between. The floral bracts are much longer and much more conspicuous in some specimens

that in others. The number of flowers open simultaneously per inflorescence varies from a single to almost all. Usually the margin of the lip is distinctly ciliate, but sometimes it is only papillose or even glabrous.

3. Mainly on account of the structure of the lip it is possible to distinguish two subspecies, with only few specimens left as intermediates (see the note under subsp. *cassideum*). The two subspecies have somewhat different, although overlapping geographical ranges.

#### KEY TO THE SUBSPECIES

- 1a. Lip with the top not or only slightly curved, adx. with the ridges up to approx. 3/4 of the total length of the lip (stretch the lip!) . . . . . a. subsp. *orbiculare*
- b. Lip with the top distinctly curved, adx. with the ridges at least up to 4/5 of the total length of the lip (stretch the lip!), generally almost up to the tip . . . . . b. subsp. *cassideum*

#### a. subsp. *orbiculare* – Figs. 58j, 67a–j.

*Bulbophyllum orbiculare* J.J. Smith, Bull. Jard. Bot. Buitenzorg II, 3 (early 1912) 23; Nova Guinea 12, 1 (1913) 94. — Type: Gjellerup 483 (not seen).

*Bulbophyllum glabrilabre* J.J. Smith, Fedde, Rep. 12 (1913) 404; Nova Guinea 12, 4 (1916) 413. — Type: Gjellerup 830 (BO, L).

*Bulbophyllum habropus* Schltr., Fedde, Rep. Beih. 1 (1913) 873; 21 (1928) f. 1172. — Type: Schlechter 20096 (B, †).

*Bulbophyllum verrucirhachis* Schltr., Fedde, Rep. Beih. 1 (1913) 873; 21 (1928) f. 1173. — Syntypes: Schlechter 18684 (B, †; iso AMES, L), 19687 (B, †).

*Lip* with the top not or only slightly curved; adx. with the ridges up to approx. 3/4 of the total length of the lip (stretch the lip!).

Ecology – Epiphyte in primary forest. Occasionally found in secondary vegetation. Alt. 650–2500 m asl. Flowering mainly 1, 2, 6, 7 and 10–12.

Distribution – INDONESIA & PAPUA NEW GUINEA. New Guinea (widespread and common); New Ireland; Bougainville. – SOLOMON ISLANDS. Kolombangara; Guadalcanal.

Notes – 1. The specimen Gjellerup 830, type of *Bulbophyllum glabrilabre*, has a lip somewhat approaching *B. graciliscapum* in shape. It is, however, approx. equally wide over much of its length, not distinctly ovate, and it is therefore included in *B. orbiculare* (see Fig. 58j).

2. A few specimens (e.g. Bacon 4740) are characterized by the very short (3–7 cm), coarsely verrucose inflorescences with 2–4 flowers only. Otherwise these specimens are not aberrant.

#### b. subsp. *cassideum* (J.J. Smith) J.J. Vermeulen, *stat. nov.* – Fig. 67k–n.

*Bulbophyllum orbiculare* Schltr. subsp. *cassideum* (J.J. Smith) J.J. Vermeulen – *Bulbophyllum cassideum* J.J. Smith, Fedde, Rep. 11 (Oct. 1912) 138; Nova Guinea 12, 4 (1916) 412. — Type: Gjellerup 849 (BO).

*Bulbophyllum errabundum* Ridley, Trans. Linn. Soc. II, 9 (1916) 189. — Type: Kloss s.n. (AMES, K, BM).

*Bulbophyllum truncatisepalum* J.J. Smith, Bull. Jard. Bot. Buitenzorg III, 9 (1928) 469; id., Suppl. 2, 3–4 (1934) f. 93. — Type: Toxopeus n. BeO (BO, L).

*Lip* with the top distinctly curved; adx. with the ridges at least up to 4/5 of the total length of the lip (stretch the lip!), generally almost up to the tip.

Ecology – Epiphyte in primary forest. Alt. 1000–2000 m asl. Flowering observed in 1–4, 7–9 and 11.

Distribution – INDONESIA & PAPUA NEW GUINEA. Buru; Seram; New Guinea (widespread but not in the southern lowlands); Karkar.

Note – A few specimens are intermediate between *Bulbophyllum orbiculare* subsp. *cas-sideum* and subsp. *orbiculare*: NGF 36702 (Ridsdale), and Jongejan 1779 have the top part of the lip not distinctly curved, although the ridges adaxially continue almost to the tip of the lip. Mason 224 and 2121 have the top part of the lip distinctly curved but the ridges not continuing up to the tip of the lip.

#### 41. *Bulbophyllum oreodoxa* Schltr. – Fig. 68.

*Bulbophyllum oreodoxa* Schltr., Fedde, Rep. Beih. 1 (1913) 869; 21 (1928) f. 1164. — Syntypes: Schlechter 18532 (lecto B, †; isolecto AMES, BM, BO, K), 18270 (B, †).

*Bulbophyllum chaetopus* Schltr., Fedde, Rep. Beih. 1 (1913) 868; 21 (1928) f. 1163. — Type: Schlechter 19686 (B, †).

*Rhizome* creeping, 0.5–1.5 mm diam.; rhizome scales of the longest internodes shorter to slightly longer than those internodes. *Roots* in tufts below each pseudobulb. *Pseudobulbs* ovoid to approx. orbicular, 0.4–2 cm apart, 0.2–0.7 by 0.15–0.5 cm, not flattened. *Petiole* 0.3–5 mm. *Leaf blade* ovate to elliptic, 0.5–2.5 by 0.3–0.8 cm, index 1.3–4.6, tip acute to acuminate. *Inflorescence* 3–8 cm, 2–7-flowered. *Peduncle* 1.7–6.8 cm; bracts 3–5, the longest 2–4 mm. *Rachis* erect or arching, 0.2–2.5 cm. *Floral bracts* ovate, 1.2–2.5 mm, tip acute. *Pedicel and ovary* 3–6 mm, with the node 0.3–1 mm from the floral bract. *Flowers* all open at the time, moderately opening. *Median sepal* ovate, 6–12 by 1.3–2 mm, index 4.5–10, tip long acuminate to caudate; thin; glabrous. *Lateral sepals* free, 6–12.5 by 1.4–2.2 mm, index 4–7, otherwise as the median sepal. *Petals* ovate to elliptic, 1.5–2.5 by 0.8–1.4 mm, index 1.4–2.2, tip obtuse to acute; thin; glabrous. *Lip* curved, general outline ovate, 1.5–1.8 by 0.8–1.2 mm, index 1.5–2.5 (not spread), tip rounded to subacute; thick but soft; glabrous; adx. concave near the base; abx. with an inconspicuous, retuse, median ridge. *Column* from ovary to the tip of the stelia 0.5–0.8 mm; stigma protruding at its base, obovate; column-foot without accessories. *Stelidia* inconspicuous, triangular, tip acute; sometimes with an inconspicuous, rounded wing along the lower margin. *Anther* abx. with a ridge; front margin protruding. *Pollinia* 2.

Colours – Flowers white or cream-coloured.

Ecology – Epiphyte in forest. Also found on village trees. Alt. 450–1500 m asl. Flowering observed in 1, 6–10.

Distribution – PAPUA NEW GUINEA. New Guinea (central mountain range from Western and Southern Highlands Prov. to Milne Bay Prov.).

Notes – 1. It differs from *Bulbophyllum levatii* in being of much smaller stature, and in having at most a very inconspicuous tooth along the lower margins of the stelia. The differences from *B. kaniense* are mentioned under that species.

2. *Bulbophyllum oreodoxa* can also be confused with *B. dendrochiloides* as well as with *B. phormion*. The differences between the three are given under *B. phormion*.



3. Schlechter's drawing of *Bulbophyllum oreodoxa* shows 4 pollinia. In isotype specimens only 2 pollinia are present. Possibly Schlechter made a mistake here.

#### 42. *Bulbophyllum phormion* J.J. Vermeulen – Fig. 69.

*Bulbophyllum phormion* J.J. Vermeulen, *Rheedea* 2 (1992) 3. — Type: Cruttwell 3180 (L).

*Rhizome* creeping but sometimes with the most recently developed parts patent or pendulous, 0.8–1 mm diam.; rhizome scales of the longest internodes (distinctly) shorter than those internodes, leaving bare large portions of the rhizome. *Roots* in tufts below most pseudobulbs. *Pseudobulbs* ovoid to approx. discoid, 0.5–3.2 cm apart, 0.2–1.1 by 0.1–0.6 cm, not or hardly flattened. *Petiole* 1–15 mm. *Leaf blade* approx. elliptic, 0.7–4 by 0.25–0.8 cm, index 1.6–10, tip obtuse to acute. *Inflorescence* 2–17 cm, 2–10-flowered. *Peduncle* 1.7–9.5 cm; bracts 3–5, the longest 2–6 mm. *Rachis* erect, 0.3–6 cm. *Floral bracts* ovate to triangular, 1.2–3 mm, tip acute. *Pedicel and ovary* 2–13 mm, with the node 0.3–0.8 mm from the floral bract. *Flowers* all open at the time, moderately opening. *Median sepal* ovate to triangular, 4–11 by 1.2–2.5 mm, index 3–9, tip long acuminate; rather thin; glabrous. *Lateral sepals* free, 4–15 by 1.4–2.5 mm, index 2.6–10, otherwise as the median sepal. *Petals* oblique, elliptic to obovate, 1.2–3.5 by 0.5–1 mm, index 2–3.9, tip obtuse to acute; margins glabrous to erose; thin; surface glabrous. *Lip* straight or slightly curved, general outline ovate, more or less divided into a basal part which is semi-circular or semi-elliptic in lateral view and which cannot be spread out entirely, and a narrow, flat or slightly convex top part, 1.8–3 by 0.5–0.8 mm, index 2.3–4.2 (not spread), tip obtuse to acute; rather thin and solid; approx. glabrous; adx. slightly concave in the basal part, with 2 inconspicuous ridges converging in front approx. half-way; abx. approx. without a median ridge. *Column* from ovary to the tip of the stelia 0.5–1 mm; stigma protruding at its base, approx. elliptic; column-foot without accessories. *Stelidia* inconspicuous, triangular, tip rounded to acute; upper margin erose. *Anther* abx. with a ridge; front margin not protruding. *Pollinia* 2.

*Colours* – Pseudobulbs often stained with purple. Sepals and petals yellowish or creamy white, sometimes suffused with pink or purple, or entirely purple. Lip yellowish or white, sometimes with a purple blotch near the base, or entirely dark purple.

*Ecology* – Epiphyte in primary and secondary forest. Also found in isolated trees in grassland. Alt. 2200–3200 m asl. Flowering observed in 1, 4, 5, 9, 10.

*Distribution* – INDONESIA & PAPUA NEW GUINEA. New Guinea (central mountain range from Sudirman Ra. to Owen Stanley Ra.).

*Notes* – 1. *Bulbophyllum phormion*, *B. dendrochiloides* and *B. oreodoxa* are rather similar and can be confused easily. *Bulbophyllum oreodoxa* can always be recognized by the comparatively short and wide, recurved lip which, in lateral view, becomes only a little thinner towards its tip; *B. phormion* and *B. dendrochiloides* both have a lip which is, in lateral view, generally more or less divided into a high and wide basal part, tapering into a much narrower and thinner top part. In case this division is indistinct, the fact that the lip is at most very slightly curved helps distinguishing the two from *B. oreodoxa*.

In *Bulbophyllum dendrochiloides* the top part of the lip is rather thin, but of solid texture. In *B. phormion* the top part of the lip is thick but of a soft, spongy texture. Other, less

decisive differences between *B. phormion* and *B. dendrochiloides* can be found in the inflorescence: in the former this has fewer flowers and generally is much less dense. Besides, in *B. phormion* a slightly stronger tendency exists to form partly patent rhizomes.

2. *Bulbophyllum phormion* shows a distinct variability in the size of the vegetative parts, as well as in the length of the sepals. The shape of the lip and of the column, however, is very constant.

#### 43. *Bulbophyllum pidacanthum* J.J. Vermeulen – Fig. 70.

*Bulbophyllum pidacanthum* J.J. Vermeulen, Rheedea 2 (1992) 5. — Type: Rees & Reeve 327 (K).

*Rhizome* patent or more or less pendulous, up to 12 cm long, 2–3 mm diam.; all rhizome scales longer than the internodes. *Roots* generally close to the base of the rhizome. *Pseudobulbs* ovoid, 0.6–2 cm apart, 1.5–3 by 0.4–0.6 cm, moderately flattened. *Petiole* 4–9 mm. *Leaf blade* elliptic, 4.5–6.5 by 1.1–1.5 cm, index 3–5, tip acute. *Inflorescence* 11–30 cm, 20–75-flowered. *Peduncle* 2.5–7.5 cm; bracts 3–4, the longest 5–12 mm. *Rachis* arching, more or less pendulous, 9–24 cm. *Floral bracts* ovate, 2–5 mm, tip acute to acuminate. *Pedicel and ovary* 8–25 mm, with the node 1–4 mm from the floral bract. *Flowers* many open at the time, moderately opening. *Median sepal* ovate, 11.5–17 by 1.5–3.2 mm, index 6.5–8.5, tip long acuminate to caudate; rather thin; glabrous. *Lateral sepals* free, oblique, 14.5–21 by 1.5–2.2 mm, index 7–14, otherwise as the median sepal. *Petals* oblique, ovate to elliptic, 1.2–2.2 by 1–1.6 mm, index 1.1–1.7, tip obtuse; otherwise as the median sepal. *Lip* slightly curved, general outline ovate, consisting of a wider basal part and a narrow, approx. linear top part, 1.7–2 by 0.7–0.9 mm, index 2–2.6 (not spread), tip obtuse; margins and surface glabrous to papillose; rather thick; adx. moderately concave near the base, with 2 ridges converging in front in the basal half, abx. with a truncate median ridge. *Column* from ovary to the tip of the stelia 0.8–1.3 mm; stigma protruding at its base, approx. orbicular; column-foot without accessories. *Stelidia* triangular, 0.2–0.3 mm; tip acute; with a distinct, deltoid, rounded to acute wing along the lower margin. *Anther* abx. with a ridge; front margin protruding. *Pollinia* 2.

Colours – Leaves often suffused with purple. Sepals pale greenish, cream-coloured or white. Petals, lip and column white, often with purple veins, suffused with purple, or entirely purple.

Ecology – Epiphyte in primary forest, also in more open vegetation. Alt. 1500–2600 m asl. Flowering observed in 3, 4, 8, 10, 11.

Distribution – INDONESIA & PAPUA NEW GUINEA. New Guinea (Sudirman Ra. to Whar-ton Ra.).

Note – Vegetatively similar to *Bulbophyllum scopa*. It differs in having narrower sepals as well as in the outline of the lip, which is distinctly narrowed towards its tip.

#### 44. *Bulbophyllum scopa* J.J. Vermeulen – Fig. 71.

*Bulbophyllum scopa* J.J. Vermeulen, Blumea 34 (1990) 503. — Type: Jongejan 1670 (L).

*Rhizome* patent, up to 12 cm long, 1.5–2.5 mm diam.; all rhizome scales longer than the internodes. *Roots* generally close to the base of the rhizome. *Pseudobulbs* ovoid, 0.3–1.5 cm apart, 1.3–2.8 by 0.3–0.5 cm, moderately flattened. *Petiole* 2–15 mm. *Leaf blade*

elliptic, 3.5–9 by 0.4–1.2 cm, index 5.5–14, tip acute. *Inflorescence* 4.5–17 cm, 2–12-flowered. *Peduncle* 2.5–9 cm; bracts 3–4, the longest 6–9 mm. *Rachis* erect or arching, 2–8 cm. *Floral bracts* ovate to elliptic, 2.5–4 mm, tip acute. *Pedicel and ovary* 5–10 mm, with the node 1–2 mm from the floral bract. *Flowers* many open at the time, moderately opening. *Median sepal* ovate to elliptic, 8–16 by 3.5–5.5 mm, index 2.2–3.5, tip acute to shortly acuminate; thin; glabrous. *Lateral sepals* free, oblique, ovate to triangular, 8–16 by 2.5–4 mm, index 2.3–4.2, otherwise as the median sepal. *Petals* ovate to approx. orbicular, 2.5–4.5 by 2–3.5 mm, index 1–1.4, tip obtuse to acute; otherwise as the median sepal. *Lip* slightly curved, general outline ovate, 2.2–3 by 1.8–2 mm, index 1.2–1.7 (not spread), tip rounded; thick but soft; glabrous; adx. concave near the base, with 2 distinct, narrow ridges converging and touching in front; abx. with a retuse median ridge. *Column* from ovary to the tip of the stielidia 1–1.5 mm; stigma with a protruding tooth at its base, approx. orbicular; column-foot without accessories. *Stielidia* inconspicuous, tip obtuse to acute. *Anther* abx. with a ridge; front margin not protruding. *Pollinia* 2.

Colours – Sepals and petals yellow or yellowish green, with or without purple veins. Lip yellow, greenish or suffused with purple towards the tip.

Ecology – Epiphyte in primary forest. Alt. 1200–2000 m asl. Flowering 3, 4, 6–9.

Distribution – INDONESIA & PAPUA NEW GUINEA. New Guinea (central mountain range from Sudirman Ra. to Owen Stanley Ra.).

Note – The differences from *Bulbophyllum pidacanthum* are given under the latter species.

#### 45. *Bulbophyllum trifilum* J.J. Smith

Literature: see under the subspecies.

*Rhizome* erect, patent or pendulous with more or less patent branches, up to c. 60 cm long, 0.5–2 mm diam.; rhizome scales of the longest internodes distinctly shorter than those internodes, leaving bare large portions of the rhizome. *Roots* generally close to the base of the rhizome. *Pseudobulbs* ovoid, 0.6–6 cm apart, 0.2–2 by 0.1–0.4 cm, not flattened. *Petiole* 2–10 mm. *Leaf blade* ovate to elliptic, 0.9–13 by 0.2–1.5 cm, index 1.8–33, flat or semi-terete in section, tip acute to acuminate. *Inflorescence* 0.5–15 cm, 1–18-flowered. *Peduncle* 0.5–8 cm; bracts 3–4, the longest 2–6 mm. *Rachis* generally pendulous, 0.1–5.5 cm. *Floral bracts* ovate to triangular, 2–5 mm, tip acute. *Pedicel and ovary* 2–5 mm, with the node 0.2–1.5 mm from the floral bract. *Flowers* all open at the time, moderately opening. *Median sepal* ovate to triangular, 3.5–26 by 1.2–4.4 mm, index 3–13, tip long acuminate to caudate; thin; glabrous. *Lateral sepals* free, oblique, 3.5–31 by 1.2–4 mm, index 2.9–16, otherwise as the median sepal. *Petals* oblique, ovate to elliptic, 1.3–3.8 by 0.6–2.5 mm, index 1.5–3, tip obtuse to acuminate; margins glabrous to slightly erose; thin; surface glabrous. *Lip* curved, general outline ovate, 1.2–3.4 by 0.7–2 mm, index 1.3–2.5 (not spread), tip obtuse to acute; thick but soft; approx. glabrous; adx. concave near the base, abx. with an inconspicuous, retuse median ridge. *Column* from ovary to the tip of the stielidia 0.4–1.2 mm; stigma protruding at its base, obovate; column-foot without accessories. *Stielidia* inconspicuous, triangular, tip acute; upper margin sometimes erose, with or without an inconspicuous to distinct, rounded to acute tooth along the lower margin. *Anther* abx. with a ridge; front margin protruding. *Pollinia* 2.

Colours – Sepals and petals pale greenish, yellowish or (creamy) white, sometimes suffused with some purple, or with purple veins. Lip cream-coloured, yellow or purple.

Ecology – Epiphyte in primary forest. Also found in secondary forest and on village trees. Alt. 300–2400 m asl. Flowering observed in 3, 5–11.

Notes – 1. This species is similar to *Bulbophyllum macrourum*. It has, however, narrower leaves, and it grows in a slightly different way: in *B. macrourum* all rhizomes hang down perpendicularly, while in *B. trifilum* the rhizomes are generally patent, or hanging down obliquely. Occasionally the plant as a whole may be hanging down, but then the lateral rhizome portions are more or less patent. The lip, observed in lateral view, reveals a third difference: it is approx. equally thick up to, or over half-way of its length, and only a little thinner towards the tip in *B. macrourum*, whereas in *B. trifilum* it is thickest near its base, and distinctly tapering towards the tip.

2. As several other species of this section, *Bulbophyllum trifilum* shows extensive variability in several aspects: in the size of the vegetative parts as well as of the flowers, and in the presence/absence a small wing along the lower margin of the stledia. Intermediates have been found between all extremes.

3. A few specimens, conspicuously characterized by having semi-terete leaves, probably combined with somewhat larger flowers, are included here in a separate subspecies. Plants with similarly semi-terete leaves are found, next to otherwise approx. identical plants with flat leaves, in a number of *Bulbophyllum* species of several sections, e.g. sect. *Aphanobulbon* [the couple *B. unguiculatum* Reichb. f. and *B. teres* Carr; *B. mutabile* (Blume) Lindl. and its var. *obesum* J.J. Vermeulen], or section *Oxysepalum* [the couple *B. sessile* (Koen.) J.J. Smith and *B. scotifolium* J.J. Smith].

#### KEY TO THE SUBSPECIES

- 1a. Leaves coriaceous but not extremely fleshy. Leaf index 1.8–9 a. subsp. *trifilum*
- b. Leaves very fleshy, semi-elliptic or semi-terete in section. Leaf index 10–33  
b. subsp. *filisepalum*

a. subsp. *trifilum* – Figs. 72, 73a–e; Plate 3d.

*Bulbophyllum trifilum* J.J. Smith, Bull. Dép. Agr. Ind. Néerl. 19 (1908) 10; Nova Guinea 8, 1 (1911) 102. — Type: Versteeg 1511 (holo BO, iso K, L).

*Bulbophyllum cavistigma* J.J. Smith, Fedde, Rep. 11 (1912) 279; Nova Guinea 12, 4 (1916) 407. — Type: Gjellerup 828 (BO).

*Bulbophyllum fatuum* J.J. Smith, Fedde, Rep. 11 (1912) 280; Nova Guinea 12, 4 (1916) 409. — Type: Gjellerup 844 (BO).

*Bulbophyllum recurvmarginatum* J.J. Smith, Nova Guinea 18, 1 (1935) 67. — Type: Docters van Leeuwen 10773 (BO, L).

*Leaf blade* 0.9–7.5 by 0.2–1.5 cm, index 1.8–9, flat or semi-terete in section. *Median sepal* 3.5–20 mm long. *Lateral sepals* 3.5–25 mm long.

*Distribution* – INDONESIA & PAPUA NEW GUINEA. Seram; New Guinea (widespread but not in Cendrawasih Peninsula and the southern lowlands).

*Note* – The only specimen from Seram (Edwards 172, see Fig. 73a–e) is exceptionally small in all parts, but intermediates have been found in Irian Jaya (e.g. the type of *Bulbophyllum cavistigma*).

b. subsp. *filisepalum* (J.J. Smith) J.J. Vermeulen, *stat. nov.* – Fig. 73f–h.

*Bulbophyllum trifilum* subsp. *filisepalum* (J.J. Smith) J.J. Vermeulen – *Bulbophyllum filisepalum* J.J. Smith, *Nova Guinea* 12, 4 (1916) 408. — Type: Janowsky 412 (holo L, iso BO).

*Leaf blade* 5.5–13 by 0.2–0.8 cm, index 10–33, flat or semi-terete in section. *Median sepal* 22–26 mm long. *Lateral sepals* 23–31 mm long.

*Distribution* – INDONESIA & PAPUA NEW GUINEA. New Guinea (central mountain range from Jaramaniapuka Ra. to Wharton Ra.).

### Series C

Base of the stigma not protruding from the face of the column.

Stelidia deltoid, triangular or semicircular.

### 46. *Bulbophyllum desmotrichoides* Schltr. – Fig. 74.

*Bulbophyllum desmotrichoides* Schltr., *Fedde, Rep. Beih.* 1 (1913) 871; 21 (1928) f. 1169. — Syntypes: Schlechter 18498 & 20264 (both B, †). Neotype: Kalkman & Nicolas 4220 (L).

*Bulbophyllum breviscapum* J.J. Smith, *Bull. Dép. Agr. Ind. Néerl.* 39 (1910) 2 – *Bulbophyllum planifolium* Kintredge, *Bot. Mus. Leafl. Harv. Un.* 30 (1984) 100. — Type: von Römer 435 (BO).

Non *Bulbophyllum breviscapum* (Rolfe) Ridley, *Mat. Fl. Mal. Pen.* 1 (1907) 78 (= *B. lasiochilum* Par. & Reichb. f.).

*Rhizome* erect, patent, or pendulous with more or less patent branches, up to 70 cm long, 1–4 mm diam.; rhizome scales of the longest internodes distinctly shorter than those internodes, leaving bare large portions of the rhizome. *Roots* generally close to the base of the rhizome. *Pseudobulbs* ovoid to ellipsoid, 0.6–14 cm apart, 0.7–4.5 by 0.2–0.8 cm, not flattened. *Petiole* 2–11 mm. *Leaf blade* ovate to elliptic, 3–9 by 0.9–3.3 cm, index 2.2–7, tip obtuse to acute. *Inflorescence* 1.3–4 cm, 5–20-flowered. *Peduncle* 0.8–1.3 cm; bracts c. 3, the longest 3–8 mm. *Rachis* erect, 0.7–1.7 cm. *Floral bracts* triangular, 0.3–0.8 mm, tip acute. *Pedicel and ovary* 3.8–9 mm, with the node 0.2–0.4 mm from the floral bract. *Flowers* many open at the time, moderately opening. *Median sepal* ovate, 3–6.2 by 1–2.5 mm, index 1.6–3, tip obtuse to acute; rather thick; glabrous. *Lateral sepals* free, oblique, 3.2–7 by 1–2.2 mm, index 2.6–4.6; otherwise as the median sepal. *Petals* oblique, ovate, 1.8–2.7 by 1–1.3 mm, index 1.8–2.4, thin; otherwise as the median sepal. *Lip* approx. straight, general outline ovate, 1.3–1.8 by 0.4–0.8 mm, index 2.2–3.2 (not spread), tip rounded; thick; glabrous; adx. distinctly concave and with 2 distinct curved ridges converging in front as well as in the back in the lower half; abx. without a median ridge. *Column* from ovary to the tip of the stelidia 0.5–1.2 mm; stigma not protruding at its base, approx. orbicular; column-foot without accessories. *Stelidia* triangular, tip acute; often an small rounded, tooth along the upper margin, close to the tip. *Anther* abx. with a ridge towards its tip; front margin not protruding. *Pollinia* 4; the inner pair c. half as long as the outer pair.

*Colours* – Sepals (pale) yellow to cream-coloured. Petals whitish. Lip pale yellow, often suffused with purple near the base.

*Ecology* – Epiphyte in primary forest. Also found in secondary forest. Alt. 200–2000 m asl. Flowering 6, 7, 9–11.

Distribution – INDONESIA & PAPUA NEW GUINEA. Halmahera; New Guinea (central mountain range from Jayawijaya Ra. to Owen Stanley Ra. Also in mountain ranges N of Sepik R., as well as in lowlands S of Sudirman Ra.).

Notes – 1. Within Series C characterized by the following combination: the patent rhizome, the presence of 4 pollinia, the straight lip and the 5–20-flowered inflorescences.

2. *Bulbophyllum breviscapum* was founded on a specimen with relatively small (c. 1 cm high) pseudobulbs. Carr 10154 has similar pseudobulbs. Otherwise these specimens do not differ from the other specimens, including the type of *B. desmotrichoides* (fide descr. Schlechter).

#### 47. *Bulbophyllum dichotomum* J.J. Smith – Fig. 75.

*Bulbophyllum dichotomum* J.J. Smith, Bull. Dép. Agr. Ind. Néerl. 19 (1908) 5. — Type: Versteeg 1537 (holo BO; iso K, L, P).

*Rhizome* patent to pendulous with more or less patent branches, up to c. 200 cm long, 0.8–1.8 mm diam.; rhizome scales of the longest internodes distinctly shorter than those internodes, leaving bare large portions of the rhizome. *Roots* generally close to the base of the rhizome, but occasionally sprouting along the entire rhizome. *Pseudobulbs* ellipsoid, to cylindrical, 1.3–31 cm apart, 0.5–1.8 by 0.1–0.4 cm, not flattened. *Petiole* 0.8–3 mm. *Leaf blade* ovate, 2.8–11.7 by 0.5–2.1 cm, index 3–12, tip acute to acuminate. *Inflorescence* 0.8–1.2 cm, (1–)2-flowered. *Peduncle* 0.1–0.3 cm; bracts c. 3, the longest 1.8–3 mm. *Rachis* 0.02 cm. *Floral bracts* ovate, 0.3–2.5 mm, tip obtuse to acuminate. *Pedicel and ovary* 1.2–2.5 mm, with the node 0.2–0.8 mm from the floral bract. *Flowers* open at the time, moderately opening. *Median sepal* ovate, 3.5–6 by 0.8–1.6 mm, index 3.5–5, tip acuminate; thin; glabrous. *Lateral sepals* free, ovate to triangular, 4.5–6.5 by 0.8–1.5 mm, index 3.6–6.5; otherwise as the median sepal. *Petals* (ob)ovate to elliptic, 1.2–2.1 by 0.5–1.3 mm, index 1.5–4.2, tip obtuse to acuminate; margins glabrous or finely erose; thin; surface glabrous. *Lip* approx. straight, general outline ovate, 1–1.7 by 0.3–0.7 mm, index 2.1–3.8 (not spread), tip obtuse; thick; glabrous; adx. concave and with 2 ridges converging in front near its base; abx. without a median ridge. *Column* from ovary to the tip of the stielidia 0.5–1 mm; stigma not protruding at its base, approx. orbicular; column-foot approx. without accessories. *Stielidia* triangular, tip acute. *Anther* abx. with a ridge towards its tip; front margin protruding. *Pollinia* 2.

Colours – Plant dark green. Flowers cream-coloured or white.

Ecology – Epiphyte in primary forest. Alt. 700–3000 m asl. Flowering 7, 8, 10, 11.

Distribution – INDONESIA & PAPUA NEW GUINEA. New Guinea (central mountain range from Sudirman Ra. to Owen Stanley Ra. Also Finisterre Mts); Bougainville. – VANUATU. Ambae; Espiritu Santo; Anatom.

Note – Differs from the other species of this series by the generally 2-flowered inflorescences, the straight lip and the presence of 2 pollinia only. Vegetatively it is distinct because of its ovate leaves.

#### 48. *Bulbophyllum glaucum* Schltr. – Fig. 76.

*Bulbophyllum glaucum* Schltr., Fedde, Rep. Beih. 1 (1913) 866; 21 (1928) f. 1157. — Type: Schlechter 20080 (holo B, †; iso AMES).

*Rhizome* hanging down perpendicularly, up to 30 cm long, flattened and winged, largest diam. 0.8–1.4 mm; rhizome scales of the longest internodes distinctly shorter than those internodes, leaving bare large portions of the rhizome. *Roots* generally close to the base of the rhizome, spreading. *Pseudobulbs* cylindrical, 0.5–1.5 cm apart, 0.15–0.25 by 0.1–0.15 cm, not flattened. *Petiole* 1.5–2 mm. *Leaf blade* ovate to elliptic, 1–1.8 by 0.6–1.2 cm, index 1.5–2.3, tip acuminate. *Inflorescence* c. 2.5 cm, 1-flowered. *Peduncle* 0.8–1.2 cm; bracts 3, the longest 3.5 mm. *Floral bracts* ovate, c. 4 mm, tip acuminate. *Pedicel and ovary* c. 5.5–7 mm, with the node c. 1 mm from the floral bract. *Flowers* moderately opening. *Median sepal* ovate, 12.5–25 by 2 mm, index 6–13, tip long acuminate; thin; glabrous. *Lateral sepals* free, oblique, approx. triangular, 13–25 by 4 mm, index 3–5.5, *Petals* oblique, ovate to elliptic, 4–5 by 1.7 mm, index 2.3–3, tip obtuse; thin; glabrous. *Lip* curved, general outline ovate, 5–7 by 2–2.5 mm, index 2.5–3 (not spread), tip rounded; thick but soft; glabrous; adx. concave near the base; abx. with an inconspicuous, retuse median ridge. *Column* from ovary to the tip of the stelia 1.2 mm; stigma not protruding at its base, slit-like, column-foot without accessories. *Stelidia* inconspicuous, triangular, tip subacute. *Anther* abx. with a ridge; front margin not protruding. *Pollinia* 2. Colours – Sepals and petals pale pink. Lip reddish.

*Ecology* – Epiphyte in primary forest. Alt. 800 m asl. Flowering 9 (all from one observation).

*Distribution* – PAPUA NEW GUINEA. New Guinea (mountain ranges N of Sepik R.).

*Notes* – 1. Within the series characterized by the flattened rhizome which hangs down perpendicularly.

2. Only a single 1-flowered inflorescence is present on the available material. It is unknown whether *Bulbophyllum glaucum* always has 1-flowered inflorescences, or whether it may have 2- or 3-flowered inflorescences as well, just as e.g. *B. cateorum* and *B. mulderae*. In case it only has 1-flowered inflorescences, it can also be included in sect. *Oxysepalum*. However, because of a similarity with the above mentioned species, it is included in sect. *Macrouris*.

3. Insufficiently known. A single isotype specimen only was available for this revision, with a single, much flattened flower. The drawings of the lip are reconstructions based on this material.

#### 49. *Bulbophyllum imitator* J.J. Vermeulen – Fig. 77.

*Bulbophyllum imitator* J.J. Vermeulen, *Rheedea* 2 (1992) 7. — Type: LAE 67057 (Vinas & Waikabu) (holo AMES; iso BRI, CANB, K, L, LAE).

*Rhizome* patent or pendulous with more or less patent branches, up to c. 60 cm long, 1.5–3 mm diam.; rhizome scales of the longest internodes slightly shorter than or as long as those internodes. *Roots* generally close to the base of the rhizome. *Pseudobulbs* ovoid, 0.5–1.3 cm apart, 0.6–2.2 by 0.3–0.6 cm, not flattened. *Petiole* 1–5 mm. *Leaf blade* ovate to elliptic, 2.2–7 by 0.5–1.4 cm, index 4.4–6, tip obtuse to acute. *Inflorescence* 1.1–3 cm, 4–6-flowered. *Peduncle* 0.5–1.5 cm; bracts c. 3, the longest 3.5–5.5 mm. *Rachis* approx. erect, 0.5–1.5 cm. *Floral bracts* ovate, 3–5 mm, tip acute. *Pedicel and ovary* 2.5–3.5 mm, with the node 0.7–0.8 mm from the floral bract. *Flowers* all open at the time, moderately opening. *Median sepal* ovate to elliptic, 5–6 by 2.2–2.3 mm, index 2–2.7, tip obtuse to acute; thin; glabrous. *Lateral sepals* free, oblique, ovate, 5.2–6 by 2–

2.7 mm, index 2–3, tip approx. acute; thin; glabrous. *Petals* oblique, elliptic to obovate, 2–2.2 by 1.5–1.8 mm, index c. 1.2, tip obtuse; margins glabrous to finely papillose; thin; surface glabrous. *Lip* distinctly curved, general outline ovate, 1.5–1.8 by 1.2 mm, index c. 1.5 (not spread), tip obtuse; thick; glabrous; adx. distinctly concave, with 2 distinct ridges approx. parallel to the margins, abx. with a retuse median ridge. *Column* from ovary to the tip of the stelia 0.9–1 mm; stigma not protruding at its base, slit-like; column-foot without accessories. *Stelidia* triangular, tip acute; with a small, obtuse tooth along the upper as well as the lower margin, close to the tip. *Anther* abx. with a ridge towards its base; front margin not protruding. *Pollinia* 4; the inner pair c. half as long as the outer pair.

Colours – Pseudobulbs and leaves often suffused with purple. Pedicel purple. Flowers yellow; lip with a purple blotch in the centre.

Ecology – Epiphyte in primary forest. Alt. 2800–3000 m asl. Flowering observed in 1, 4.

Distribution – PAPUA NEW GUINEA. New Guinea (central mountain range: Mt Capella; Wharton Ra.).

Notes – 1. Vegetatively *Bulbophyllum imitator* is entirely identical with *B. ochroleucum* (sect. *Uncifera*). It differs in the shape of the lip, which has two ridges along the margins, as well as in the stelia which lack the downwards pointing tooth along their lower margin.

2. Within this series it is distinguished by the 4–6-flowered inflorescences combined with the curved lip.

3. Two specimens were available of this species. They have almost identical flowers but differ greatly in the size of the vegetative parts.

#### INCOMPLETELY KNOWN SPECIES

##### ***Bulbophyllum* spec. (Kostermans & Soegeng 741).**

*Rhizome* perpendicularly hanging down, up to c. 65 cm long, flattened and winged, largest diam. 2 mm; rhizome scales of the longest internodes distinctly shorter than those internodes, leaving bare large portions of the rhizome. *Roots* most close to the base of the rhizome, spreading. *Pseudobulbs* ovoid, 1.5–4.5 cm apart, 0.6–1 by 0.2–0.3 cm, not flattened. *Petiole* 1.5–3 mm. *Leaf blade* elliptic, 3–4.8 by 1–1.5 cm, index 3–4, tip acuminate. *Inflorescence* (?) cm, 3–5-flowered. *Peduncle* 0.8–1.2 cm; bracts (?), the longest c. 4 mm. *Rachis* approx. pendulous, 0.6–1.2 cm. *Flowers* (not present).

Colours – Leaves purple abx. Flowers white.

Ecology – Alt. 2000–2500 m asl. Flowering 8 (all from one record).

Distribution – INDONESIA. Irian Jaya.

Notes – 1. Shares with *Bulbophyllum cateorum* and *B. glaucum* a flattened and winged rhizome which hangs down perpendicularly. It differs from those species in having larger pseudobulbs, as well as distinctly longer and narrower leaves.

2. Incompletely known. For this revision only one specimen with very young flower buds was available.

##### ***Bulbophyllum* spec. (O'Byrne 260).**

*Rhizome* creeping, 1–1.5 mm diam.; all rhizome scales slightly shorter or longer than the internodes. *Roots* in tufts below each pseudobulb. *Pseudobulbs* ovoid to discoid, 2–5 cm



apart, 0.7–1.5 by 0.4–0.8 cm, not laterally flattened. *Petiole* 8–20 mm. *Leaf blade* ovate to elliptic, 2–5 by 1.4–2.3 cm, index 1.5–2.2, tip to acuminate. *Inflorescence* (not present).

**Colours** – Plant dark green, leaves somewhat purple abx. Sepals and petals whitish with purple veins. Lip yellowish.

**Ecology** – Epiphyte. Alt. 800–1000 m asl. Flowering 8 (all from one record).

**Distribution** – PAPUA NEW GUINEA. New Guinea (central mountain range: Morobe Prov.).

**Notes** – 1. Vegetatively this species looks much like *Bulbophyllum fonsflorum*, although it probably has somewhat longer petioles. The inflorescence as well as the flowers are more like *B. muscicola*. The lip differs from that species in being narrower, as well as in having two short, distinct keels.

2. Incompletely known. For this revision only one sterile specimen was available, as well as a pencil drawing made by the collector.

### Section *Pelma*

*Bulbophyllum* section *Pelma* (Finet) Schltr., Fedde, Rep. Beih. 1 (1913) 703 & 855. – *Pelma* Finet, Not. Syst. 1 (1909) 112. — Syntype species: *Pelma absconditum* (J.J. Smith) Finet, *P. neocaledonicum* (Schltr.) Finet (= both *Bulbophyllum absconditum* J.J. Smith).

*Dactylorhynchus* Schltr., Fedde, Rep. Beih. 1 (1913) 890. — Type species: *Dactylorhynchus flavescens* Schltr. (= *Bulbophyllum latipes* J.J. Smith).

*Rhizome* patent to pendulous; rhizome scales longer than the internodes they cover. *Roots* generally sprouting below the older pseudobulbs only. *Inflorescence* with 1 or more flowers. *Median sepal*: tip obtuse to caudate. *Petals* distinct, not very small. *Lip* not divided into lobes; with an inconspicuous to distinct concavity immediately above the ligament (not in *Bulbophyllum ankylorhinon*, *colliferum*, *leucothyrsus*, *ochthochilum*); immediately in front of this concavity two converging teeth which together form a transverse ridge (not in *B. ochthochilum*). *Column*: rostellum distinctly protruding or not; base of the stigma protruding (often as a beaklike structure) in lateral view or not, but without teeth; column-foot with a thick median knob immediately above the ligament which fits into the basal concavity of the lip (absent or very inconspicuous in *B. ankylorhinon*, *colliferum*, *leucothyrsus*, *ochthochilum*). *Stelidia* absent or present, without a tooth along their lower margin (or in

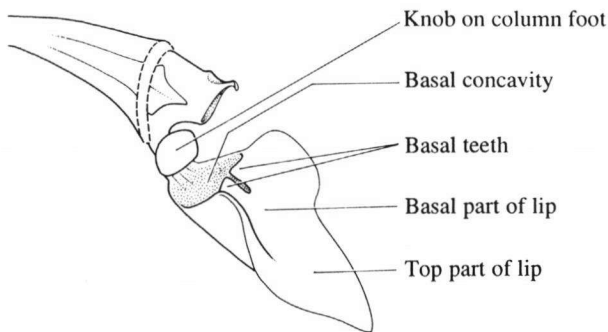

Fig. 23. Terminology used for the description of the column and the lip in *Bulbophyllum* sect. *Pelma* and sect. *Peltopus*.

case the stelidia are absent: the lateral margins of the stigma without a tooth). *Pollinia* 4, the inner pair more than half as long as the outer pair. *Stipes* present.

Notes – 1. Section *Pelma* is characterized by the following polythetic set: Rhizome hanging; petals distinct (not very small); lip with a concavity near its base, in which fits a knob on the column-foot.

2. To distinguish between the species of sect. *Pelma* the structures on the adaxial side of the lip are very important. To facilitate the description of these structures the following terms are introduced here (see Fig. 23):

*Basal concavity* — The concavity at the adaxial side of the lip, near its base, immediately above the ligament, in which the knob on the column-foot fits.

*Basal teeth* — The converging teeth on the adaxial side of the lip, which together constitute the frontal margin of the basal concavity.

*Basal part of lip* — The portion of the lip immediately in front of the basal teeth. This part is described separately if it is distinct (e.g. concave) from the top part of the lip.

*Top part of lip* — The portion of the lip between the basal part and the tip. If the basal part is not described separately, the top part includes the portion of the lip between the basal teeth and the tip.

3. Diagnostic structures on the lip are often invisible in decayed or excessively shrivelled herbarium material. Even after boiling the flowers, such specimens can hardly be identified with this key. In some cases it may help to soak a flower in warm, strong ammonia or in a ditto NaOH-solution.

#### KEY TO THE SPECIES OF SECTION PELMA

- 1a. Some or all inflorescences with 2 flowers or more (a few 1-flowered inflorescences may be present) . . . . . 2
- b. All inflorescences 1-flowered . . . . . 19
- 2a. Margins of the petals with distinct, coarse, much elongated papillae. Lateral sepals 22–32 mm long . . . . . 51. *B. ankylorhinon*
- b. Margins of the petals glabrous, erose or with papillae which are not elongated. Lateral sepals 13 mm or shorter . . . . . 3
- 3a. Lip adx. with a distinct concavity close to its tip; this concavity separated from the basal concavity by the basal teeth only, which together form a transverse ridge with a slit half-way . . . . . 4
- b. Lip *either* adx. approx. flat or convex close to its tip; *or* lip slightly concave close to its tip, but then this concavity separated from the basal concavity by two transverse swellings (the basal teeth, as well as a second transverse ridge or median tooth or median callus in front of these) . . . . . 5
- 4a. Petals 2–2.3 mm long. Lip 2.2–2.3 mm long . . . . . 55. *B. gyaloglossum*
- b. Petals 0.6–1.5 mm long. Lip 0.4–1.2 mm long . . . . . 66. *B. savaiense*
- 5a. (3) Lip adx. in the top half with a rather inconspicuous to distinct, rounded to acute central tooth or callus (see Fig. 24b, c); or, approx. half-way, with a second transverse ridge next to the basal teeth (see Fig. 24a) . . . . . 6
- b. Lip adx. in the top half flat to convex, but without a true central tooth or callus . . . . . 8

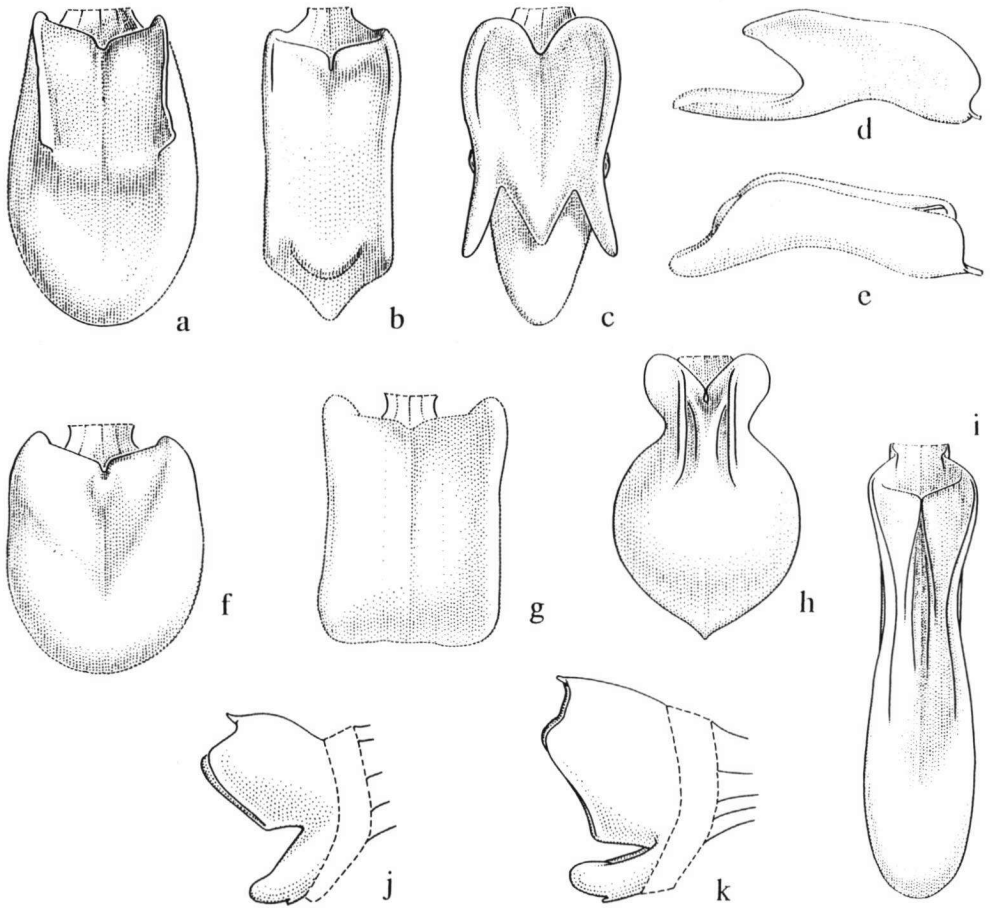

Fig. 24. Explanatory sketches with the key to the species of *Bulbophyllum* sect. *Pelma*.

- 6a. Lip adx. approx. half-way with a second transverse ridge next to the basal teeth (see Fig. 24a) ..... 62. *B. mischobulbon*  
 b. Lip adx. in the top half with a rather inconspicuous to distinct, rounded to acute central tooth or callus ..... 7
- 7a. Lip in lateral view with distinct lateral lobes (see Fig. 24d) .... 61. *B. mesodon*  
 b. Lip in lateral view without lateral lobes (see Fig. 24e) ... 70. *B. xanthochlamys*
- 8a. (5) Lip adx. approx. without a basal concavity ..... 9  
 b. Lip adx. with a basal concavity ..... 11
- 9a. Knob on column-foot present, generally incurved. Either very fine glandular hairs present along the margins of the sepals (check with 30 times magn.), or the concave basal part of the lip passing into the top part of the lip with a v-shaped transverse edge (see Fig. 24f), or both characteristics mentioned present (but see also note 2 under *B. fractiflexum* subsp. *fractiflexum*) ..... 54. *B. fractiflexum*

- b. Knob on column-foot absent; if a slight thickening is present this is not incurved. Margins of the sepals glabrous. The concave basal part of the lip gradually passing into the top part (see Fig. 24g). . . . . 10
- 10a. Leaves in a flowering portion of the plant 7–15 mm wide. Inflorescence 15–35 mm long. Rachis 3–17 mm long . . . . . 53. **B. colliferum**
- b. Leaves in a flowering portion of the plant 21–55 mm wide. Inflorescence 38–220 mm long. Rachis 25–190 mm long . . . . . 58. **B. leucothyrus**
- 11a. (8) Lip distinctly pandurate in outline: wide at the base, distinctly constricted in the basal half and wide again in the top half (see Fig. 24h) . . . . . 56. **B. latipes**
- b. Lip at most very slightly constricted in the basal half (see Fig. 24i); or lip approx. elliptic in outline . . . . . 12
- 12a. Petals 3–3.8 mm long. Lip 2.4–2.7 mm long. Inflorescences 3–8-flowered. Leaf blades in flowering portion of the plant 5.3–8.5 by 1–2.3 cm . . . . . 13
- b. Petals 1–2.6 mm long. Lip 0.7–2.5 mm long. If lip longer than 2.2 mm, then inflorescences 1–3-flowered, and leaf blades 0.9–3 by 0.2–0.6 cm . . . . . 14
- 13a. Basal teeth touching at the tip, but lower down leaving open a wide channel in between them . . . . . 52. **B. bacilliferum**
- b. Basal teeth touching along their entire front margins, leaving only an approx. closed slit in between them . . . . . 60. **B. melanoxanthum**
- 14a. (12) Knob on column-foot not or only very slightly incurved (see Fig. 24j, k) . . . . . 15
- b. Knob on column-foot distinctly incurved . . . . . 16
- 15a. Lip not or only very slightly concave in front of the basal teeth. Margins of sepals glabrous . . . . . 57. **B. leptoleucum**
- b. Lip distinctly concave in front of the basal teeth. Margins of sepals usually (not always, and check with 30 by magn.) with stalked papillae . . . . . 54. **B. fractiflexum**
- 16a. (14) Inflorescence with 10–30 flowers. Lip adaxially, next to the basal teeth, with two longitudinal, parallel ridges . . . . . 69. **B. tanystiche**
- b. Inflorescence with 1–8 flowers. Lip adaxially, next to the basal teeth, without ridges or with two distinctly convergent ridges . . . . . 17
- 17a. Rostellum not visible when the column is observed laterally . . . . . 59. **B. macilentum**
- b. Rostellum distinctly protruding when the column is observed laterally . . . . . 18
- 18a. Leaf blade 0.6–4 cm wide. Margins of sepals usually with stalked papillae (not always; check with 30 by magn.). Basal concavity very inconspicuous  
54. **B. fractiflexum**
- b. Leaf blade 0.2–0.6 cm wide, index 7.5–13. Margins of sepals approx. glabrous, without stalked papillae. Basal concavity very distinct . . . . . 64. **B. oliganthum**
- 19a. (1) Lip recurved (check lip in lateral view) . . . . . 20
- b. Lip straight or incurved (the extreme tip may be somewhat recurved). . . . . 22

- 20a. Lip adaxially with a distinct callosity close to the tip . . . . **63. B. ochthochilum**  
 b. Lip adaxially flat or convex close to the tip, but without a callosity . . . . . 21
- 21a. Lip distinctly pandurate in outline: wide at the base, distinctly constricted in the basal half and wide again in the top half (see Fig. 24h) . . . . . **56. B. latipes**  
 b. Lip ovate to elliptic in outline, at most very slightly constricted in the basal half  
**65. B. pachytelos**
- 22a. (19) Top part of the lip distinctly convex. Lip very thick and solid from the base to the extreme tip . . . . . **67. B. simile**  
 b. Top part of the lip concave or flat. Lip (rather) thick, thinner towards the tip . . . 23
- 23a. Lip distinctly constricted approx. half-way, with a projecting, tongue-shaped top part. Petals distinctly oblique, index 0.6–1.2 (the length measured along the midvein, ignoring the projection along the lower margin; the width measured perpendicularly on the length) . . . . . **68. B. stipulaceum**  
 b. Lip either not constricted; or lip slightly constricted just beyond its widest part, top part of the lip not truly projecting. Petals only slightly oblique, index 1.2–2.3  
**50. B. absconditum**

**50. Bulbophyllum absconditum J.J. Smith**

Literature: see under the subspecies.

*Rhizome* patent to pendulous, up to 45 cm long, 0.6–2 mm diam. *Pseudobulbs* ovoid, ellipsoid, or globose, 0.4–2 cm apart, 0.2–1.3 by 0.2–0.5 cm, somewhat flattened or not. *Petiole* 0.5–1 mm. *Leaf blade* ovate to elliptic, 0.6–3.5 by 0.2–0.6 cm, index 1.9–7, tip acuminate. *Inflorescence* 0.3–0.5 cm, 1-flowered. *Peduncle* 0.1–0.2 cm; bracts 1, 1.5–3 mm. *Floral bracts* tubular, 1.1–2.8 mm, tip acuminate. *Pedicel and ovary* 0.7–1.5 mm, with the node 0.1–0.4 mm from the floral bract. *Flowers* widely opening. *Median sepal* ovate, 1.4–2.5 by 0.8–1.3 mm, index 1.5–3.1, tip obtuse to acuminate; rather thick; glabrous. *Lateral sepals* free, oblique, 1.5–2.4 by 0.6–1 mm, index 2–3; otherwise as the median sepal. *Petals* somewhat oblique, ovate to elliptic, 0.5–1 by 0.3–0.7 mm, index 1.2–2.3, tip (sub)acute; margins glabrous or slightly erose, often with one inconspicuous tooth at both sides; thin; surface glabrous. *Lip* approx. straight, general outline ovate to subhastate, 0.5–0.9 by 0.3–0.6 mm, index 1.2–2 (not spread), tip rounded to acute; thick, thinner towards the tip; glabrous or somewhat papillose; adx. with a distinct basal concavity, basal teeth converging, together forming a transverse ridge with a deep notch half-way, top part of the lip slightly concave; abx. without a median ridge. *Column* from ovary to the tip of the rostellum 0.3–0.5 mm; rostellum distinctly protruding; stigma ovate, slightly protruding at its base; column-foot with a distinct, rounded central knob above the attachment of the lip. *Stelidia* absent or inconspicuous, if present deltoid, tip obtuse. *Anther* abx. with a ridge towards its base; front margin somewhat protruding.

Colours – Sepals and petals translucent white, pale yellow or pale green. Lip white, yellow, pale green or orange.

Notes – 1. The differences from *Bulbophyllum stipulaceum* are given under the latter species.

2. Mainly on account of the shape of the lip two subspecies can be distinguished:

#### KEY TO THE SUBSPECIES

- 1a. Top part of the lip rounded, with or without a short, somewhat protruding apiculus  
a. subsp. **absconditum**  
b. Top part of the lip gradually tapering into a (sub)acute tip . . . . . b. subsp. **hastula**

a. subsp. **absconditum** – Fig. 78a–h.

*Bulbophyllum absconditum* J.J. Smith, Fl. Buitenzorg 6 (1905) 449. – *Pelma absconditum* Finet, Not. Syst. 1 (1909) 113. — Syntypes: Korthals s.n. (lecto L, 904.44-48/49).

*Bulbophyllum neocaledonicum* Schltr., Bot. Jahrb. 39 (1906) 84. – *Pelma neocaledonicum* Finet, Not. Syst. 1 (1909) 113. — Type: Schlechter 15492 (holo B, †; iso AMES, B, BO, E, K, L, S, W, WRSL).

*Bulbophyllum ochrochlamys* Schltr., Fedde, Rep. Beih. 1 (1913) 856; 21 (1928) f. 1137. — Type: Schlechter 17300 (B, †).

*Rhizome* up to 25 cm long, 1–2 mm diam. Top part of the *lip* rounded, with or without a short, somewhat protruding apiculus.

*Ecology* – Epiphyte in primary forest. Also found in very open vegetation, or in isolated trees. Alt. 100–1900 m asl. Flowering 1, 2, 12 in New Caledonia; 1–10 elsewhere.

*Distribution* – PHILIPPINES. Negros (Edaño PNH 5369, sterile but presumably belonging here). – INDONESIA & PAPUA NEW GUINEA. Sumatra (once collected long ago: Korthals s.n., of slightly doubtful origin); Jawa; Bali; Flores; New Guinea (Southern Highlands Prov.; Huon Peninsula). – VANUATU. Espiritu Santo. – NEW CALEDONIA.

b. subsp. **hastula** J.J. Vermeulen, *subsp. nov.* – Fig. 78i.

*Bulbophyllum absconditum* subsp. *hastula* a subsp. typica a labelli apice (sub)acuto differt. — Typus: Kalkman & Nicolas 4223 (holo L; iso AMES).

*Rhizome* up to 45 cm long, 0.6–1.2 mm diam. Top part of the *lip* gradually tapering into a (sub)acute tip.

*Ecology* – Epiphyte in primary forest. Alt. 100–1500 m asl. Flowering observed in 6, 10.

*Distribution* – INDONESIA & PAPUA NEW GUINEA. New Guinea (Sibil Valley; upper Fly R. basin; south Sepik R. basin).

Note – The name refers to the shape of the lip: the Latin ‘*hastula*’, meaning a small arrow.

**51. *Bulbophyllum ankylorhinon* J.J. Vermeulen – Fig. 79; Plate 4a.**

*Bulbophyllum ankylorhinon* J.J. Vermeulen, Rheedea 2 (1992) 10. — Type: Jongejan 1287 (L).

*Rhizome* patent to pendulous, up to 60 cm long, 4–5 mm diam. *Pseudobulbs* ovoid to ellipsoid, 2–8 cm apart, 2.5–4 by 0.8–1 cm, somewhat flattened. *Petiole* 3–6 mm. *Leaf blade* elliptic, 6.5–18 by 1.3–2 cm, index 4.7–10, tip (sub)acute. *Inflorescence* c. 3 cm,

3–5-flowered. *Peduncle* c. 0.7 cm; bracts c. 3, the longest c. 7 mm. *Rachis* 0.8–1.4 cm. *Floral bracts* approx. triangular, 12–15 mm, tip acute. *Pedicel and ovary* 4.5–5 mm, with the node 0.2 mm from the floral bract. *Flowers* moderately opening. *Median sepal* ovate, 21–32 by 3.5–3.8 mm, index 5.5–7, tip acute; margins distinctly ciliate; rather thick; adx. finely papillose except at the base; abx. glabrous. *Lateral sepals* free, 22–32 by 3.8–4 mm, index 5.5–7; otherwise as the median sepal. *Petals* 7–9 by 1.8–2.5 mm, index 3.5–5, tip obtuse; margins with coarse, elongated papillae; adx. glabrous at the base, coarsely papillose-ciliate at the tip and finely papillose in between; otherwise as the median sepal. *Lip* slightly curved, general outline approx. elliptic, 2–2.5 by 1.5–2 mm, index 1.2–1.3 (not spread), tip rounded; margins with coarse, elongated papillae; very thick; adx. without a basal concavity, without basal teeth, basal part of the lip moderately concave, slightly papillose, passing with a transverse edge or ridge into the top part of the lip, top part slightly convex, with a median furrow, papillose; abx. without a median ridge, surface approx. glabrous. *Column* from ovary to the tip of the rostellum c. 1 mm; rostellum distinctly protruding; stigma a transverse slit with a distinct, obtuse central tooth at its base; column-foot approx. without accessories. *Stelidia* inconspicuous, triangular, tip acute. *Anther* abx. with a ridge; front margin not protruding.

Colours – Sepals and petals white or creamy yellow. Lip orange or red.

Ecology – Epiphyte in primary forest. Alt. 1700–2000 asl. Flowering observed in 5, 9.

Distribution – PAPUA NEW GUINEA. New Guinea (central mountain range: Bismarck Ra.; Wharton Ra. Also Huon Peninsula).

Note – Well characterized by the coarse, elongate papillae along the margins of the petals and the lip, as well as by the large flowers.

## 52. *Bulbophyllum bacilliferum* J.J. Smith – Fig. 80.

*Bulbophyllum bacilliferum* J.J. Smith, Bull. Jard. Bot. Buitenzorg III, 10 (1928) 155; id., Suppl. 2, 3-4 (1934) f. 93. — Type: Rutten 2239 (holo L; iso BO).

*Rhizome* pendulous, up to 85 cm long, 2–3 mm diam. *Pseudobulbs* ovoid to ellipsoid, 2.5–5 cm apart, 2–3.5 by 0.6–0.8 cm, somewhat flattened. *Petiole* 6–8 mm. *Leaf blade* ovate to elliptic, 5.3–6.5 by 1.8–2 cm, index 2.9–3.2, tip acute. *Inflorescence* 2.4–3.6 cm, 3–5-flowered. *Peduncle* 1.2–1.8 cm; bracts c. 3, the longest c. 4 mm. *Rachis* 1.2–1.8 cm. *Floral bracts* triangular, 2.7–3.2 mm, acute. *Pedicel and ovary* c. 2.8 mm, with the node c. 1.3 mm from the floral bract. *Flowers* hardly opening. *Median sepal* elliptic, c. 5 by 1.4 mm, index c. 3.6, tip short acuminate; rather thick; glabrous. *Lateral sepals* free, oblique, ovate, c. 5 by 1.3 mm, index c. 3.8, tip acute; otherwise as the median sepal. *Petals* obovate, c. 3.8 by 1 mm, index 3.8, tip acute; thin; glabrous. *Lip* curved towards the tip, general outline approx. elliptic, somewhat narrowed half-way, c. 2.7 by 0.9 mm, index c. 3.9 (not spread), tip rounded; thick; glabrous; adx. with a distinct basal concavity, basal teeth converging, touching at the tip, but lower down leaving open a wide channel in between them, basal part of the lip distinctly concave, gradually passing into the convex top part of the lip; abx. with an inconspicuous, truncate median ridge. *Column* from ovary to the tip of the rostellum c. 0.4 mm; rostellum distinctly protruding; stigma approx. orbicular, protruding at its base; column-foot with a rounded central knob above the attachment of the lip. *Stelidia* approx. absent. *Anther* abx. with a ridge which does not protrude beyond the front margin; front margin not protruding.

Colours – Not known.

Ecology – Epiphyte in primary forest. Alt. 1000–1100 m asl. Flowering 5 (all from one record).

Distribution – INDONESIA. Seram.

Notes – 1. *Bulbophyllum bacilliferum* and *B. melanoxanthum* are characterized by the narrow, glabrous lip with a rounded tip. The differences between the two are given under the latter species.

2. Both species are represented by one, respectively a few specimens only. The differences between the two may need re-evaluation once more material becomes available.

### 53. *Bulbophyllum colliferum* J.J. Smith – Fig. 81; Plate 4b.

*Bulbophyllum colliferum* J.J. Smith, Bull. Jard. Bot. Buitenzorg II, 2 (1911) 17; Nova Guinea 12, 1 (1913) 92. — Type: Rachmat 442 (BO).

*Bulbophyllum niveosulphureum* Schltr., Fedde, Rep. Beih. 1 (1913) 860; 21 (1928) f. 1147. — Type: Schlechter 16970 (B, †).

*Bulbophyllum papulilabium* Schltr., Fedde, Rep. Beih. 1 (1913) 861; 21 (1928) f. 1148. — Type: Schlechter 16447 (B, †).

*Rhizome* erect to pendulous, up to 100 cm long, 2.5–5 mm diam. *Pseudobulbs* ovoid, 2–4.2 cm apart, 20–55 by 0.5–0.8 cm, hardly flattened. *Petiole* 1–5 mm. *Leaf blade* ovate to elliptic, 3.8–10.2 by 0.7–1.5 cm, index 5.5–8, tip (sub)acute. *Inflorescence* 1.5–3.5 cm, 2–5-flowered. *Peduncle* 0.7–1.3 cm; bracts 4–5, the longest 5–10 mm. *Rachis* 0.3–1.7 cm. *Floral bracts* ovate, 3–8 mm, tip acute. *Pedicel and ovary* 2–4 mm, with the node c. 1 mm from the floral bract. *Flowers* hardly to moderately opening. *Median sepal* ovate to elliptic, 4–6.8 by 2–3 mm, index 1.7–2.5, tip acute; thick; glabrous. *Lateral sepals* free, ovate, 4.3–7 by 1.5–3 mm, index 1.4–3.3, otherwise as the median sepal. *Petals* oblique, ovate to elliptic, 1.2–2 by 1.2–2 mm, index 0.9–1.5, tip rounded to acute; margins glabrous to finely papillose; rather thick; surface glabrous. *Lip* curved, general outline (ob)ovate to approx. rectangular, 0.8–1.3 by 0.6–1 mm, index 1–1.3 (not spread), tip rounded; margins finely to coarsely papillose; thick; adx. without a basal concavity, basal teeth a very inconspicuous transverse ridge, basal part of the lip slightly concave, glabrous or papillose, gradually passing into the flat or convex, almost glabrous to coarsely papillose top part of the lip; abx. without a median ridge, surface approx. glabrous. *Column* from ovary to the tip of the stolidia 0.7–1 mm; rostellum not protruding; stigma obovate, not protruding at its base; column-foot approx. without accessories. *Stolidia* inconspicuous, triangular, tip obtuse to acute. *Anther* abx. with a ridge; front margin hardly protruding.

Colours – Sepals and petals white or cream-coloured. Lip white, cream-coloured, orange or red.

Ecology – Epiphyte in primary forest. Alt. 400–3000 m asl. Flowering observed in 3, 5, 10, 12.

Distribution – INDONESIA & PAPUA NEW GUINEA. New Guinea (central mountain range from Sudirman Ra. to Owen Stanley Ra.).

Notes – 1. Shares with *Bulbophyllum leucothyrsus* the lack of a basal concavity on the lip. *Bulbophyllum leucothyrsus* differs in being much larger in all parts, in particular in the width of the leaves and the length of the inflorescences.



2. Next to rather sturdy plants with erect or patent rhizomes (as the illustrated specimen), plants occur of a more elongate appearance.

3. The surface of the lip varies from almost glabrous (the type of *Bulbophyllum niveo-sulphureum*) to coarsely papillose (the types of *B. colliferum* and *B. papulilabium*. All intermediates occur.

#### 54. *Bulbophyllum fractiflexum* J.J. Smith

Literature: see under the subspecies.

*Rhizome* pendulous, up to 90 cm long, 1.5–3.5 mm diam. *Pseudobulbs* ovoid to ellipsoid, 0.5–9 cm apart, 0.9–3.2 by 0.3–1.5 cm, somewhat flattened or not. *Petiole* 1–10 mm. *Leaf blade* ovate to elliptic, 2–12 by 0.6–4 cm, index 2–6.7, tip acute. *Inflorescence* 1.3–3.5 cm, 3–8-flowered. *Peduncle* 0.4–1 cm; bracts 3–4, the longest 3.5–8 mm. *Rachis* 0.6–2.8 cm. *Floral bracts* ovate to triangular, 2.8–5.5 mm, tip acute. *Pedicel and ovary* 1.8–2.4 mm, with the node 0.3–0.7 mm from the floral bract. *Flowers* hardly to widely opening. *Median sepal* ovate, 3.8–10.2 by 0.7–1.9 mm, index 2.2–11.4, tip obtuse to acuminate or caudate; margins usually (not always!) with fine glandular hairs; rather thin to thick; surface glabrous. *Lateral sepals* free, 4–10.8 by 0.7–1.8 mm, index 2.2–10.8; otherwise as the median sepal. *Petals* ovate to elliptic, 1–1.8 by 0.25–0.9 mm, index 1.4–4, tip obtuse to short acuminate; margins finely papillose and/or erose towards the tip; thin; surface glabrous. *Lip* curved, general outline (ob)ovate to elliptic, 0.7–1.8 by 0.3–1.3 mm, index 1.2–2.4 (not spread), tip rounded to obtuse; thick; glabrous or slightly and finely papillose; adx. without a basal concavity or with an inconspicuous one, basal teeth rather distinct, converging, fused to a transverse ridge with a notch half-way, basal part of the lip concave, gradually or with a v-shaped transverse edge passing into the convex top part of the lip; abx. without a median ridge. *Column* from ovary to the tip of the rostellum 0.3–0.8 mm; rostellum protruding; stigma a transverse slit to approx. orbicular, slightly protruding and often with an inconspicuous, rounded central knob at its base; column-foot with a small, usually incurved, rounded central knob above the attachment of the lip. *Stelidia* absent or inconspicuous, if present deltoid, tip rounded. *Anther* abx. with a wide ridge; front margin not protruding.

Notes – 1. A unique feature in *Bulbophyllum fractiflexum*, although not occurring in all specimens, is the presence of glandular hairs along the margins of the sepals.

2. *Bulbophyllum fractiflexum* differs from *B. leptoleucum* in the shape of the lip. In the former this is distinctly concave in front of the basal teeth, in the latter it is not or hardly so. Next to that, *B. leptoleucum* generally is a smaller plant.

3. *Bulbophyllum fractiflexum* is extremely variable, see the note under subsp. *fractiflexum*. On account of slightly different measurements two subspecies can be distinguished.

#### KEY TO THE SUBSPECIES

- 1a. Index median sepal 3–11.4. Index lateral sepals 3.3–10.8. Lip 0.7–1.3 mm long
  - a. subsp. *fractiflexum*
- b. Index median sepal 2.2–2.6. Index lateral sepals 2.2–2.8. Lip 1.7–1.8 mm long
  - b. subsp. *solomonense*

**a. subsp. *fractiflexum*** – Fig. 82, 83a–g; Plate 4c.

*Bulbophyllum fractiflexum* J.J. Smith, Bull. Dép. Agr. Ind. Néerl. 19 (1908) 6; Nova Guinea 8, 1 (1911) 93. — Type: Versteeg 1295 (holo BO; iso K, L, P, U).

*Bulbophyllum effusum* Schltr., Fedde, Rep. Beih. 1 (1913) 862; 21 (1928) f. 1151. — Type: Schlechter 18461 (B, †).

*Bulbophyllum fractiflexoides* Schltr., Fedde, Rep. Beih. 1 (1913) 861; 21 (1928) f. 1149. — Type: Schlechter 19688 (B, †).

*Bulbophyllum genybrachium* Schltr., Fedde, Rep. Beih. 1 (1913) 862; 21 (1928) f. 1150. — Type: Schlechter 16486 (B, †).

*Bulbophyllum lamprobulbon* Schltr., Fedde, Rep. Beih. 1 (1913) 863; 21 (1928) f. 1152. — Type: Schlechter 16681 (B, †).

*Bulbophyllum linearipetalum* J.J. Smith, Nova Guinea 14, 3 (1929) 463. — Type: Feuilletau de Bruyn 147 (BO, L).

Non *Bulbophyllum fractiflexum* Pabst, Arq. Jardim Bot. Rio de Janeiro 14 (1956) 23 (= *B. pabstii* Garay, sect. *Xiphisuzza*).

*Inflorescence* 2–3.5 cm. *Peduncle* 0.5–1 cm. *Rachis* 1.2–2.8 cm long. *Median sepal* 4–10.2 by 0.7–1.7 mm, index 3–11.4. *Lateral sepals* 4.1–10.8 by 0.7–1.7 mm, index 3.3–10.8. *Lip* 0.7–1.3 by 0.3–0.9 mm.

*Colours* – Sepals and petals (greenish) white or cream-coloured.

*Ecology* – Epiphyte in primary forest. Alt. 100–2000 m asl. Flowering 2, 4–11.

*Distribution* – INDONESIA & PAPUA NEW GUINEA. Ambon; New Guinea (widespread but not in the Cendrawasih Peninsula and the southern lowlands); Biak Isl. – SOLOMON ISLANDS. New Georgia.

*Notes* – 1. Extreme variability occurs in the characteristics listed below:

— *The size of the vegetative parts.* Two more or less extreme forms have been depicted on the plate.

— *The shape of the sepals.* These may vary from obtuse (e.g. the type of *B. fractiflexoides*) to long caudate (e.g. the type of *B. linearipetalum*).

— *The presence of glandular hairs along the margins of the sepals.* In the majority of the specimens these are present; in some, however, they are absent (e.g. the type of *B. genybrachium*, as well as in the only specimen available from Ambon).

— *The index and margins of the petals.* Some specimens have extremely narrow petals (e.g. the type of *B. linearipetalum*); in other specimens these are much wider. The margins may be glabrous to distinctly erose or papillose.

— *The index of the lip.* This is somewhat difficult to measure in herbarium specimens. It is certain, however, that in some specimens it is much narrower than in others.

Intermediates are found between all extreme forms; further subdivision of this entity seems impossible.

2. The specimen Reeve 3566 (K) may be a hybrid between subsp. *fractiflexum* and *B. leucothyrsus*. It has stalked papillae along the sepals as in the former species, but the structure of the lip and the column is as in the latter. Vegetatively it is somewhat sturdier than subsp. *fractiflexum* usually is; the lip is coarsely papillose, as often occurs in *B. leucothyrsus*.

**b. subsp. *solomonense*** J.J. Vermeulen & B. Lewis – Fig. 83h–k.

*Bulbophyllum fractiflexum* J.J. Smith subsp. *solomonense* J.J. Vermeulen & B. Lewis in Cribb & Lewis: Orch. Solomon Islands & Bougainville (1991) 255. — Type: Schodde & Craven 3858 (holo CANB, iso L, LAE).

*Inflorescence* 1.3–1.8 cm. *Peduncle* 0.4–0.5 cm. *Rachis* 0.6–1 cm long. *Median sepal* 3.8–5 by 1.7–1.9 mm, index 2.2–2.6. *Lateral sepals* 4–5 by c. 1.8 mm, index 2.2–2.8. *Lip* 1.7–1.8 by 1.2–1.3 mm.

Colours – Flowers cream-coloured.

Ecology – Epiphyte in primary forest. Also found in native gardens. Alt. 0–1000 m asl. Flowering observed in 7, 8.

Distribution – PAPUA NEW GUINEA. Bougainville. – SOLOMON ISLANDS. San Cristobal.

Notes – 1. Differs from the type subspecies in having wider sepals and a longer lip.

2. Contrary to the type subspecies, subsp. *solomonense* shows little variability.

## 55. *Bulbophyllum gyaloglossum* J.J. Vermeulen, *spec. nov.* – Fig. 84.

*Bulbophyllum gyaloglossum* a *B. subcubico* simile labello maiore differt. — Typus: Cruttwell 3153 (L).

*Rhizome* approx. pendulous, up to 35 cm long, c. 1.5 mm diam. *Pseudobulbs* ovoid to cylindrical, 1.5–4 cm apart, 2.5–4.2 by 0.15–0.2 cm, not flattened. *Petiole* 2–5 mm. *Leaf blade* ovate, 3.5–7 by 0.6–1.1 cm, index 4.4–7, tip acute. *Inflorescence* 4–5 cm, 5–6-flowered. *Peduncle* 1–1.5 cm; bracts c. 2, the longest 4–5 mm. *Rachis* 2.8–3.5 cm. *Floral bracts* ovate, 2.2–4 mm, tip acute. *Pedicel and ovary* 2–3 mm, with the node 0.8–1 mm from the floral bract. *Flowers* moderately opening. *Median sepal* elliptic, 2.6–2.7 by 1.6–2 mm, index 1.3–1.7, tip rounded; rather thin; glabrous. *Lateral sepals* free, ovate to elliptic, 3–3.3 by 2.3–2.5 mm, index 1.2–1.5, tip approx. apiculate; rather thin; glabrous. *Petals* oblique, obovate, 2–2.3 by 1.1–1.5 mm, index 1.3–2.1, tip rounded; thin; glabrous. *Lip* approx. straight, general outline ovate, 2.2–2.3 by 1.8 mm, index c. 1.2 (not spread), tip rounded; rather thick; approx. glabrous; adx. with a distinct basal concavity, basal teeth converging, together forming a transverse ridge with a deep slit halfway, top part of the lip also distinctly concave; abx. without a median ridge. *Column* from ovary to the tip of the stelia 1–1.4 mm; rostellum protruding; stigma approx. orbicular, protruding at its base; column-foot with a distinct, rounded central knob above the attachment of the lip. *Stelia* inconspicuous, approx. triangular, tip obtuse to acute. *Anther* abx. with a ridge, margin not protruding.

Colours – Sepals and petals white. Lip pale yellow.

Ecology – Primary forest. Alt. 2400–2600 m asl. Flowering observed in 5.

Distribution – PAPUA NEW GUINEA. New Guinea (Eastern Highlands Prov.).

Notes – 1. Differs from *Bulbophyllum savaiense* in having much larger petals and lip. The sepals are also different: specimens of *B. savaiense* with sepals of a comparable length always have a long acuminate (not a rounded to apiculate) tip.

2. The name has been derived from the Greek ‘gyalos’, hollow and ‘glottis’, lip.

## 56. *Bulbophyllum latipes* J.J. Smith – Fig. 85.

*Bulbophyllum latipes* J.J. Smith, Nova Guinea 18, 1 (1935) 65. — Type: Docters van Leeuwen 10264 (holo BO; iso L).

*Dactylorhynchus flavescens* Schltr., Fedde, Rep. Beih. 1 (1913) 891; 21 (1928) f. 1198. — Type: Schlechter 20098 (B, †).

Not *Bulbophyllum flavescens* (Blume) Lindley, Gen. & Sp. Orch. (1830) 54 (= sect. *Aphanobulbon*).

*Rhizome* patent to pendulous, up to c. 12 cm long, 1–1.5 mm diam. *Pseudobulbs* ovoid, 0.2–0.5 cm apart, 0.5–1.2 by 0.2–0.3 cm, somewhat flattened. *Petiole* 0.5–1.5 mm. *Leaf blade* ovate to elliptic, 1.2–2.3 by 0.2–0.6 cm, index 3–10, tip cuspidate. *Inflorescence* 1.3–1.5 cm, 1–2-flowered. *Peduncle* 0.9–1.1 cm; bracts 2, the longest c. 2 mm. *Rachis* if present (?) cm. *Floral bracts* approx. triangular, 1.2–1.5 mm, tip acuminate. *Pedicel and ovary* 2–2.5 mm, with the node 0.5–0.7 mm from the floral bract. *Flowers* moderately opening. *Median sepal* ovate, 2.8–4.2 by 1.3–2.5 mm, index 1.6–2.2, tip acute; thin; glabrous. *Lateral sepals* free, oblique, 2.8–4 by 1.3–2 mm, index 2–2.2; otherwise as the median sepal. *Petals* oblique, ovate to elliptic, 2.3–3 by 0.7–1.5 mm, index 2–3.2, tip acuminate; thin; glabrous. *Lip* slightly curved, general outline distinctly pandurate, 2.2–3.8 by 1.5–1.6 mm, index 1.6–2.4 (not spread), tip (sub)acute; to acuminate; rather thick; glabrous; adx. with a distinct basal concavity, basal teeth converging, together forming a transverse ridge with a deep slit half-way, basal half of the lip with a short, flat median ridge which is forked towards the base as well as two longer lateral ridges, basal half gradually passing into the top half of the lip, top half of the lip slightly convex; abx. approx. without a median ridge. *Column* from ovary to the tip of the rostellum 0.4–1.2 mm; rostellum distinctly protruding; stigma approx. elliptic, protruding at its base; column-foot with a rounded central knob above the attachment of the lip. *Stelidia* approx. absent. *Anther* much elongated, abx. with a ridge towards its tip; front margin protruding. *Pollinia* (not seen).

Colours – Sepals and petals pale green to pale yellow. Lip pale yellow.

Ecology – Epiphyte in primary forest. Alt. 200–900 m asl. Flowering observed in 9.

Distribution – INDONESIA & PAPUA NEW GUINEA. New Guinea (Mamberamo area; mountain ranges N of Sepik R.).

Notes – 1. Well characterized by the pandurate outline of the lip.

2. In the only specimen available all inflorescences have one flower. Schlechter mentions the occurrence of 2-flowered inflorescences in his description of *Dactylorhynchus flavescens*.

3. Schlechter created a new genus to accommodate this species. However, it fits perfectly in *Bulbophyllum* sect. *Pelma*. The elongated rostellum and anther are better considered as apomorphies on species level within that genus.

## 57. *Bulbophyllum leptoleucum* Schltr. – Fig. 86.

*Bulbophyllum leptoleucum* Schltr., Fedde, Rep. Beih. 1 (1913) 860; 21 (1928) f. 1146. — Type: Schlechter 19860 (B, †). Neotype: Carr 10363 (holo AMES, iso K, L, LAE, NY).

*Rhizome* approx. pendulous, up to 45 cm long, 1–2 mm diam. *Pseudobulbs* ovoid to cylindrical, 0.3–2.5 cm apart, 0.8–3 by 0.15–0.5 cm, not or hardly flattened. *Petiole* 1–7 mm. *Leaf blade* ovate to elliptic, 1.2–4.5 by 0.3–0.8 cm, index 3.3–7, tip acute. *Inflorescence* 1–3.5 cm, 3–5-flowered. *Peduncle* 0.4–1 cm; bracts 2–3, the longest 3–6 mm. *Rachis* 0.6–2.5 cm. *Floral bracts* ovate to triangular, 2–3.5 mm, tip acute. *Pedicel and ovary* 1.2–1.9 mm, with the node 0.2–1.2 mm from the floral bract. *Flowers* widely opening. *Median sepal* ovate to elliptic, 2–4.2 by 0.7–1.3 mm, index 2.2–3.5, tip acute to long acuminate; rather thin; glabrous. *Lateral sepals* free, oblique, ovate, 2.2–4 by 0.7–1.3 mm, index 2.5–4.2; otherwise as the median sepal. *Petals* oblique, elliptic to obovate, 1–2 by 0.3–0.8 mm, index 1.7–5, tip rounded to acute; margins often slightly erose and/or

papillose; thin; surface glabrous. *Lip* almost straight to curved, general outline approx. ovate to elliptic, 1–1.5 by 0.4–1 mm, index 1.1–3 (not spread), tip rounded to shortly acuminate; thick; approx. glabrous or somewhat papillose; adx. with a basal concavity, basal teeth converging, together forming a transverse ridge with a notch or a slit half-way, basal part of the lip often slightly concave, gradually passing into the convex top part of the lip; abx. without a median ridge. *Column* from ovary to the tip of the stelia 0.4–0.7 mm; rostellum not or hardly protruding; stigma obovate, protruding at its base; column-foot with an almost straight or very slightly incurved, rounded central knob above the attachment of the lip. *Stelidia* inconspicuous, triangular, tip truncate to rounded. *Anther* abx. with a wide ridge, front margin not protruding.

Colours – Sepals and petals white, cream coloured or pale yellow. Lip white to yellow.

Ecology – Epiphyte in primary forest. Alt. 1700–2400 m asl. Flowering 3, 8–10.

Distribution – INDONESIA & PAPUA NEW GUINEA. New Guinea (central mountain range from Yaramaniapuka Ra. to Owen Stanley Ra.).

Notes – 1. The differences between *Bulbophyllum leptoleucum* and *B. fractiflexum* are given in the notes under the latter.

2. *Bulbophyllum leptoleucum* shows variability in the length as well as the index of all flower parts.

### 58. *Bulbophyllum leucothyrsus* Schltr. – Fig. 87; Plate 4d.

*Bulbophyllum leucothyrsus* Schltr., Fedde, Rep. Beih. 1 (1913) 865; 21 (1928) f. 1156. — Type: Schlechter 17273 (holo B, †; iso BM, K).

*Rhizome* pendulous, up to 60 cm long, 6–9 mm diam. *Pseudobulbs* ellipsoid to ob-ovoid, 2.5–8 cm apart, 2.5–7 by 0.8–1.8 cm, moderately flattened. *Petiole* 1–15 mm. *Leaf blade* ovate to elliptic, 7.5–25 by 2.1–5.5 cm, index 2.7–6, tip acute. *Inflorescence* 3.8–22 cm, 4–19-flowered. *Peduncle* 1.5–3.5 cm; bracts 5–6, the longest 9–13 mm. *Rachis* 2.5–19 cm. *Floral bracts* triangular, 4.5–14 mm, tip acute. *Pedicel and ovary* 2–7 mm, with the node 0.3–4 mm from the floral bract. *Flowers* hardly opening. *Median sepal* ovate, 6–12 by 2.2–5 mm, index 2–3.2, tip subacute; thick; glabrous. *Lateral sepals* often adherent along their lower margins, oblique, 7–13 by 2–4 mm, index 2.5–5.5; otherwise as the median sepal. *Petals* ovate, 1.8–2.8 by 1.3–2.5 mm, index 1–2.2, tip obtuse to shortly acuminate; margins and often adaxial surface finely papillose; thick. *Lip* curved, general outline approx. rectangular to obovate, 0.9–1.5 by 0.6–1.2 mm, index 1–1.7 (not spread), tip rounded; margins finely papillose; thick; surface approx. glabrous to papillose; adx. without a basal concavity, basal teeth an inconspicuous, transverse ridge, basal part of the lip slightly distinctly concave, glabrous to slightly papillose, gradually passing into the convex, (slightly) papillose top part of the lip; abx. without a median ridge, surface glabrous. *Column* from ovary to the tip of the stelia 0.7–1 mm; rostellum slightly protruding; stigma a transverse slit, not or slightly protruding at its base; column-foot approx. without accessories. *Stelidia* inconspicuous, triangular, tip acute. *Anther* abx. with a wide ridge; front margin hardly protruding.

Colours – Sepals and petals white or cream-coloured, darkening to yellow with age. Lip white or pink.

Ecology – Epiphyte in primary forest. Alt. 300–1500 m asl. Flowering observed in 2, 8, 10.

Distribution – PAPUA NEW GUINEA. New Guinea (central mountain range from Southern Highland Prov. to Milne Bay Prov.).

Notes – 1. The differences between *Bulbophyllum leucothyrsus* and *B. colliferum* are given under the latter.

2. In *Bulbophyllum leucothyrsus* the adaxial surface of the lip may vary from approx. glabrous to distinctly papillose. As far as could be ascertained with the material available, the lateral sepals are adherent in most specimens, but not in all.

3. A possible hybrid between this species and *Bulbophyllum fractiflexum* subsp. *fractiflexum* has been found; see the note under the latter.

### 59. *Bulbophyllum macilentum* J.J. Vermeulen, *spec. nov.* – Fig. 88.

*Bulbophyllum macilentum* *B. fractiflexo* simile, sed per absentiam pilorum glandulosorum secus sepalorum margines, labelli cavitate basali profundiore, habitu graciliore distinctum. — Typus: Reeve 2862 (holo L, iso K).

*Rhizome* approx. pendulous, up to 50 cm long, 2–3 mm diam. *Pseudobulbs* ovoid to cylindrical, 1–3.8 cm apart, 1.8–4 by 0.2–0.5 cm, not or hardly flattened. *Petiole* 2–6 mm. *Leaf blade* ovate to elliptic, 2–7.5 by 0.2–0.6 cm, index 7.5–13, tip acute. *Inflorescence* 2–6 cm, 4–7-flowered. *Peduncle* 0.7–1.5 cm; bracts c. 3, the longest 6–9 mm. *Rachis* 1.3–5.3 cm. *Floral bracts* ovate to triangular, 2–4 mm, tip acute. *Pedicel and ovary* 1.5–3 mm, with the node 0.5–1 mm from the floral bract. *Flowers* widely opening. *Median sepal* (ob)ovate to elliptic, 2.2–3 by 0.8–1 mm, index 2.2–3, tip acuminate; rather thin; glabrous. *Lateral sepals* free, oblique, ovate to elliptic, 2.2–3 by 0.8–1 mm, index 2.2–3.5; otherwise as the median sepal. *Petals* oblique, elliptic to obovate, 1.2–1.5 by 0.7–0.8 mm, index 1.7–2, tip obtuse to shortly acuminate; margins slightly erose; thin; surface glabrous. *Lip* slightly curved near its base, general outline approx. elliptic to obovate, 1–1.4 by 0.4–0.7 mm, index 1.7–3.5 (not spread), tip rounded; very thick; glabrous or locally slightly papillose; adx. with a basal concavity, basal teeth converging, together forming a transverse ridge with a notch or a shallow slit half-way, basal part of the lip distinctly concave, gradually passing into the convex top part of the lip; abx. without a median ridge. *Column* from ovary to the tip of the stelia c. 0.4 mm; rostellum not protruding; stigma orbicular, slightly protruding at its base; column-foot with an incurved, rounded central knob above the attachment of the lip. *Stelidia* inconspicuous, semi-elliptic, tip rounded. *Anther* abx. with a wide ridge, front margin not protruding.

Colours – Sepals and petals white, or pale yellowish. Lip yellow.

Ecology – Epiphyte in primary forest. Also found in shrubby and open secondary forest. Alt. 1600–1800 m asl. Flowering 7–10.

Distribution – PAPUA NEW GUINEA. New Guinea (central mountain range from Western and Southern Highlands Prov. to Owen Stanley Ra.).

Notes – 1. *Bulbophyllum fractiflexum* differs in having glandular hairs along the margins of the sepals, and a rostellum which protrudes if the column is viewed laterally.

2. *Bulbophyllum leptoleucum* differs in having a lip which is not or hardly concave in front of the basal teeth, and which is more fleshy and convex towards the tip. Vegetatively it is characterized by its slender growth habit (hence its name, 'macilentus' meaning: lean or thin).

**60. *Bulbophyllum melanoxanthum* J.J. Vermeulen & B. Lewis – Fig. 89.**

*Bulbophyllum melanoxanthum* J.J. Vermeulen & B. Lewis in Cribb & Lewis: Orch. Solomon Isl. & Bougainville (1991) 255. — Type: Craven & Schodde 137 (holo CANB, iso L, LAE).

*Rhizome* pendulous, up to 50 cm long, 2.5–5 mm diam. *Pseudobulbs* ovoid, 2.5–4.5 cm apart, 2–3 by 0.6–0.8 cm, somewhat flattened. *Petiole* 4–7 mm. *Leaf blade* ovate to elliptic, 5.8–8.5 by 1–2.3 cm, index 3.3–5.8, tip acute. *Inflorescence* 2.8–5.5 cm, 4–8-flowered. *Peduncle* 1–1.7 cm; bracts c. 5, the longest 5–7 mm. *Rachis* 1.8–3.8 cm. *Floral bracts* triangular, 1.5–3.5 mm, acute. *Pedicel and ovary* c. 2 mm, with the node c. 0.7 mm from the floral bract. *Flowers* hardly opening. *Median sepal* elliptic, c. 4 by 1.8 mm, index c. 2.2, tip short obtuse; rather thick; glabrous. *Lateral sepals* free, c. 4.3 by 1.7 mm, index c. 2.5, otherwise as the median sepal. *Petals* obovate, c. 3 by 1.3 mm, index 2.3, tip rounded; margins finely papillose towards the tip; thin; surface glabrous. *Lip* curved towards the tip, general outline approx. elliptic, c. 2.4 by 1 mm, index c. 2.4 (not spread), tip rounded; thick; glabrous; adx. with a distinct basal concavity, basal teeth converging, touching along their entire proximal margins, leaving only an approx. closed slit in between them and together forming a transverse ridge, basal part of the lip concave, gradually passing into the convex top part of the lip; abx. approx. without a median ridge. *Column* from ovary to the tip of the rostellum c. 0.7 mm; rostellum distinctly protruding; stigma approx. orbicular, protruding at its base; column-foot with a rounded central knob above the attachment of the lip. *Stelidia* approx. absent. *Anther* abx. with a ridge which distinctly protrudes beyond the front margin; front margin not protruding. *Pollinia* (not seen).

Colours – Sepals and petals creamy white. Lip creamy yellow.

Ecology – Epiphyte in primary forest. Alt. 400–800 m asl. Flowering observed in 7.

Distribution – PAPUA NEW GUINEA. New Guinea [Central Prov., NGF (Isles & Vinas) 34394, sterile and of somewhat doubtful identity]; Bougainville. – SOLOMON ISLANDS. New Georgia.

Notes – 1. Differs mainly from *Bulbophyllum bacilliferum* in the structure of the basal teeth on the lip: in *B. melanoxanthum* these are touching approx. along their entire front margin, in *B. bacilliferum* they only touch at the tip, leaving a distinct channel in between them lower down. Otherwise the two species are rather similar, see the notes under *B. bacilliferum*.

2. The herbarium specimens are of a characteristic colour: with yellow pseudobulbs and almost black leaves.

**61. *Bulbophyllum mesodon* J.J. Vermeulen, *spec. nov.* – Fig. 90.**

*Bulbophyllum mesodon* in sect. *Pelmate* a labello dente mediali lobis lateralibusque distinctis insigniter proprim. — Typus: Brass 13717 (holo AMES; iso BO, L).

*Rhizome* pendulous, up to c. 90 cm long, 4–5 mm diam. *Pseudobulbs* ovoid, 7–9 cm apart, c. 3 by 1 cm, somewhat flattened. *Petiole* 8–15 mm. *Leaf blade* ovate, 11–15.5 by 3–4.3 cm, index 3.6–3.7, tip acute. *Inflorescence* 3.5–8 cm, 8–24-flowered. *Peduncle* 1–2 cm; bracts 4–5, the longest 6–8 mm. *Rachis* 2.5–5.8 cm. *Floral bracts* ovate, 4–5 mm, tip acute. *Pedicel and ovary* c. 5 mm, with the node c. 1.5 mm from the floral bract. *Flowers* hardly opening. *Median sepal* ovate, c. 3.2 by 1.3 mm, index c. 2.5, tip acute;

rather thin; glabrous. *Lateral sepals* free, c. 3.5 by 1.1 mm, index c. 3.2; otherwise as the median sepal. *Petals* oblique, approx. elliptic, c. 1.8 by 1 mm, index c. 1.8, tip acute; margins finely papillose; rather thin; surface glabrous. *Lip* 3-lobed, median lobe approx. straight, general outline ovate, c. 1.2 by 0.7 mm, index c. 1.7, tip obtuse; margins somewhat papillose towards the tip; thick; adx. with a basal concavity, basal teeth converging, together forming a transverse ridge with a notch half-way, basal part of the lip concave, approx. glabrous, passing with a distinct, triangular, approx. acute central tooth into the flat, papillose top part of the lip; abx. without a median ridge, surface glabrous; lateral lobes inserted at the level of the central tooth, distinct, triangular, c. 3.5 mm long, tip approx. acute, margins glabrous, rather thin. *Column* from ovary to the tip of the stelia c. 0.6 mm; rostellum not protruding; stigma obovate, protruding at its base; column-foot with a rounded central knob above the attachment of the lip. *Stelidia* inconspicuous, triangular, tip acute. *Anther* abx. with a wide ridge; front margin not protruding.

Colours – Sepals and petals greenish white. Lip orange.

Ecology – Epiphyte in primary forest. Alt. c. 800 m asl. Flowering 3 (all from one record).

Distribution – INDONESIA. New Guinea (Taritatu R. basin).

Notes – 1. *Bulbophyllum mesodon* is well characterized by the presence of lateral lobes on the lip, with a central tooth between them. *Bulbophyllum xanthochlamys* has a similar (less distinct) central tooth but lacks the lateral lobes.

2. The name has been derived from the Greek and refers to the median tooth on the adaxial side of the lip: 'mesos', middle and 'odous', tooth.

## 62. *Bulbophyllum mischobulbon* Schltr. – Fig. 91.

*Bulbophyllum mischobulbon* Schltr., Fedde, Rep. Beih. 1 (1913) 864; 21 (1928) f. 1154. — Type: Schlechter 18825 (B, †). Neotype: Carr 10513 (holo AMES, iso CANB, K, L, NY).

*Rhizome* pendulous, up to 100 cm long, 3–5 mm diam. *Pseudobulbs* approx. cylindrical, 2–6.5 cm apart, 3.8–8 by 0.3–0.5 cm, not flattened. *Petiole* 2–9 mm. *Leaf blade* ovate to elliptic, 3.5–11.5 by 1–2.4 cm, index 3.5–6, tip acute. *Inflorescence* 1.8–4.8 cm, 3–6-flowered. *Peduncle* 0.8–1 cm; bracts c. 3, the longest 4–8 mm. *Rachis* 0.7–3.5 cm. *Floral bracts* triangular, 2–4 mm, tip acute. *Pedicel and ovary* 3–5.5 mm, with the node 2–3 mm from the floral bract. *Flowers* hardly opening. *Median sepal* ovate to elliptic, 3–4.8 by 1.3–3 mm, index 1.6–3.3, tip acute; rather thin; glabrous. *Lateral sepals* free, oblique, ovate, 3–5.5 by 1.2–2 mm, index 2.5–3.3; otherwise as the median sepal. *Petals* approx. obovate, 1.8–3 by 1.1–1.8 mm, index 1.1–2.2, tip obtuse; margins slightly erose; thin; glabrous. *Lip* slightly curved, general outline elliptic, 1.5–2.4 by 0.6–1.5 mm, index 1.6–2.5 (not spread), tip rounded; margins somewhat finely papillose; thick; adx. with a basal concavity, basal teeth converging, together forming a transverse ridge with a notch or a slit half-way, basal part of the lip slightly concave, with two low keels close to the margins, surface approx. glabrous, passing with a second transverse, papillose ridge into the flat or slightly concave, approx. glabrous top part of the lip; abx. without a median ridge, surface slightly papillose. *Column* from ovary to the tip of the stelia 0.5–1 mm; rostellum hardly protruding; stigma approx. orbicular, protruding at its base; column-foot with a rounded central knob above the attachment of the lip. *Stelidia* inconspicuous, triangular, tip acute. *Anther* abx. with a wide ridge; front margin not protruding.

Colours – Rhizome scales dark purple. Flowers white, cream-coloured or pale yellow.



Ecology – Epiphyte in primary forest. Alt. 2000–3000 m asl. Flowering observed in 1, 9, 11.

Distribution – PAPUA NEW GUINEA. New Guinea (central mountain range from Bismarck Ra. to Owen Stanley Ra.).

Note – Characterized by the structure of the lip, with two low keels and a second transverse ridge (next to the basal teeth) on its adaxial side. The long, cylindrical pseudobulbs are not diagnostic; pseudobulbs of such a shape occur in several other species, e.g. in *Bulbophyllum savaiense* and in *B. xanthochlamys*.

### 63. *Bulbophyllum ochthochilum* J.J. Vermeulen, *spec. nov.* – Fig. 92.

*Bulbophyllum ochthochilum* in sect. *Pelmate* a inflorescentia uniflora et protuberatione prope labelli apicem insigniter proprium. — Typus: Carr 10369 (holo L, iso AMES, BM, CANB, K, LAE, NY).

*Rhizome* patent to pendulous, up to 45 cm long, 1.5–2 mm diam. *Pseudobulbs* ovoid, 0.5–1.5 cm apart, 1–1.5 by 0.2–0.4 cm, moderately flattened. *Petiole* 0.5–3 mm. *Leaf blade* ovate to elliptic, 1.5–3.5 by 0.3–0.6 cm, index 3.6–10, tip obtuse to acute. *Inflorescence* 1–1.5 cm, 1-flowered. *Peduncle* 0.4–0.8 cm; bracts 2, the longest 5.5–7 mm. *Floral bracts* tubular, 3–5 mm, tip acute. *Pedicel and ovary* 1–2 mm, with the node 0.3–0.4 mm from the floral bract. *Flowers* moderately opening. *Median sepal* ovate, 5–10 by 1–1.5 mm, index 5–6.7, tip long acuminate to caudate; rather thin; glabrous. *Lateral sepals* free, 5–9 by 1–1.6 mm, index 5–6; otherwise as the median sepal. *Petals* (ob)ovate, c. 1 by 0.2–0.5 mm, index 2–5, tip rounded to obtuse; thin; glabrous. *Lip* slightly curved, general outline approx. elliptic, 0.7–1 by 0.6–0.9 mm, index 1.1–1.2 (not spread), tip rounded; rather thick; glabrous; adx. approx. without a basal concavity, without basal teeth, top part of the lip moderately concave, with a distinct, approx. conical callosity close to the tip; abx. approx. without a median ridge. *Column* from ovary to the tip of the rostellum c. 0.7 mm; rostellum distinctly protruding; stigma transversely elliptic, distinctly protruding and with a distinct, obtuse knob at its base; column-foot with an inconspicuous, obtuse central knob above the attachment of the lip. *Stelidia* absent or inconspicuous, if present obtuse. *Anther* abx. with an inconspicuous ridge; front margin somewhat protruding.

Colours – Sepals and petals whitish. Lip deep pinkish red with a white spot in the centre.

Ecology – Epiphyte in forest. Alt. 1600 - 1700 m asl. Flowering 10, 11.

Distribution – PAPUA NEW GUINEA. New Guinea (central mountain range: Owen Stanley Ra.).

Notes – 1. Well characterized by the combination of a 1-flowered inflorescence and a callosity on the adaxial side of the lip, close to its tip.

2. The name has been derived from the Greek 'ochthos', wart and 'cheilos', lip.

### 64. *Bulbophyllum oliganthum* Schltr. – Fig. 93.

*Bulbophyllum oliganthum* Schltr., Fedde, Rep. Beih. 1 (1913) 858; 21 (1928) f. 1143. — Type: Schlechter 17196 (holo B, †; iso AMES, BM, K).

*Rhizome* pendulous, up to 25 cm long, 1–1.8 mm diam. *Pseudobulbs* ovoid to ellipsoid, 0.3–0.9 cm apart, 0.6–1.7 by 0.1–0.3 cm, not or hardly flattened. *Petiole* 1–2 mm. *Leaf blade* ovate to elliptic, 0.9–3 by 0.2–0.6 cm, index 3.4–9.5, tip acute. *Inflorescence* 0.8–1.8 cm, 1–3-flowered. *Peduncle* 0.5–0.8 cm; bracts c. 3, the longest 3.5–5 mm.

*Rachis* if present 0.4–1 cm. *Floral bracts* triangular, 2.2–4 mm, tip acute. *Pedicel and ovary* 1.2–1.7 mm, with the node 0.3–0.5 mm from the floral bract. *Flowers* moderately opening. *Median sepal* ovate to elliptic, 2–4 by 1–2 mm, index 1.7–3, tip acute to acuminate; margins slightly papillose towards the tip; rather thin; surface glabrous. *Lateral sepals* free, 2.2–4.6 by 1–2.2 mm, index 1.7–3; otherwise as the median sepal. *Petals* obovate, 1.3–2.6 by 0.7–1.6 mm, index 1.2–3, tip obtuse; margins slightly erose and slightly papillose; thin; surface glabrous. *Lip* curved, general outline ovate to elliptic, 0.9–2.5 by 0.5–1.8 mm, index 1.2–2.2 (not spread), tip obtuse; rather thick; glabrous or partly finely papillose; adx. with a basal concavity, basal teeth rather inconspicuous (usually not really separating the basal concavity and the concave basal part), converging, together forming a transverse ridge with a notch half-way (this notch may continue as a distinct channel for some distance towards the tip of the lip), basal part of the lip distinctly concave, passing with a transverse edge ridge into the top part of the lip, top part of the lip convex, with a median furrow; abx. without a median ridge. *Column* from ovary to the tip of the rostellum 0.5–1 mm; rostellum protruding; stigma approx. orbicular, protruding at its base; column-foot with an incurved, rounded central knob above the attachment of the lip. *Stelidia* inconspicuous, triangular, tip obtuse. *Anther* abx. approx. without a ridge; front margin not protruding.

Colours – Flowers cream-coloured.

Ecology – Epiphyte in primary forest. Alt. 1000–1900 m asl. Flowering observed in 1, 3–5, 7, 8, 10.

Distribution – PAPUA NEW GUINEA. New Guinea (central mountain range from Western Highlands Prov. to Wharton Ra. Also mountain ranges N of Ramu R. and Markham R.).

Note – *Bulbophyllum oliganthum* is usually characterized by the distinctly concave basal part of the lip. The basal concavity is only a minor part of this depression. The basal teeth are usually rather inconspicuous and visible approx. half-way the depression. In a few specimens, however, the depression is less distinct, and the notch between the basal teeth continues as a channel for some distance towards the tip of the lip.

## 65. *Bulbophyllum pachytelos* Schltr. – Fig. 94.

*Bulbophyllum pachytelos* Schltr. in Schum. & Laut., Nachtr. (1905) 213; Fedde, Rep. Beih. 1 (1913) 857; 21 (1928) f. 1139. — Type: Schlechter 15724 (B, †). Neotype: Carr 10461 (holo L; iso AMES, BM, CANB, K, LAE, NY).

*Bulbophyllum geminum* Schltr., Fedde, Rep. Beih. 1 (1913) 857; 21 (1928) f. 1140. — Type: Schlechter 17334 (holo B, †; iso BM).

*Bulbophyllum proximum* Schltr., Fedde, Rep. Beih. 1 (1913) 858; 21 (1928) f. 1141. — Type: Schlechter 16379 (holo B, †; iso NY).

*Rhizome* patent to pendulous, up to 40 cm long, 1–1.5 mm diam. *Pseudobulbs* (ob)-ovoid to ellipsoid, 0.8–2.5 cm apart, 0.3–1 by 0.15–0.5 cm, not to distinctly flattened. *Petiole* 0.5–1 mm. *Leaf blade* ovate to elliptic, 1–3.5 by 0.2–0.8 cm, index 2.3–6, tip acute to acuminate. *Inflorescence* 0.7–0.9 cm, 1-flowered. *Peduncle* 0.15–0.3 cm; bracts 1, 1.8–3 mm. *Floral bracts* tubular, 1.2–3.2 mm, tip acute. *Pedicel and ovary* 0.9–1.6 mm, with the node up to 0.5 mm from the floral bract. *Flowers* moderately to widely opening. *Median sepal* ovate to elliptic, 2–5 by 0.8–1.8 mm, index 2.4–3.8, tip acuminate; thin; glabrous. *Lateral sepals* free, ovate, 2–5.5 by 0.8–2 mm, index 2.5–5.5; otherwise as

the median sepal. *Petals* elliptic to (ob)ovate, 1.5–2.3 by 0.3–1 mm, index 2–5, tip obtuse to acute; thin; glabrous. *Lip* curved, general outline ovate to elliptic, 1–2 by 0.6–1.4 mm, index 1.3–2.3 (not spread), tip rounded to acute; rather thin; glabrous; adx. with a basal concavity, basal teeth converging, together forming a transverse ridge with a notch half-way, basal part of the lip concave, gradually passing into the flat or convex top part of the lip; abx. with an inconspicuous, truncate median ridge. *Column* from ovary to the tip of the stelidia 0.1–1 mm; rostellum distinctly protruding; stigma approx. orbicular, not or slightly protruding at its base; column-foot with a rounded central knob above the attachment of the lip. *Stelidia* triangular, tip obtuse to acute. *Anther* abx. with a ridge towards its base; front margin protruding.

Colours – Sepals and petals white to pale yellow. Lip pale yellow to orange.

Ecology – Epiphyte in primary forest. Alt. 300–3300 m asl. Flowering 1, 3, 5–12.

Distribution – INDONESIA & PAPUA NEW GUINEA. New Guinea (central mountain range from Sudirman Ra. to Owen Stanley Ra. Also Finisterre Mts).

Notes – 1. Differs from *Bulbophyllum leptoleucum* in having a 1-flowered inflorescence, as well as a protruding rostellum.

2. The shape of the lip is variable. It may be narrower and more pointed than in the illustrated specimens. In some specimens (e.g. the type of *Bulbophyllum proximum*, according to Schlechter's drawing) the basal part of the lip is slightly to very distinctly undulated along the margins.

3. At first glance, Schlechter's description and drawing of the lip of *Bulbophyllum pachytelos* seem to differ widely from the drawings presented in this volume. However, in poorly preserved dried flowers the lip may assume a shape similar to Schlechter's drawings, with a wide, thin base and a thick, warty, strongly recurved tip.

## 66. *Bulbophyllum savaiense* Schltr.

Literature: see under the subspecies.

*Rhizome* patent to pendulous, up to 70 cm long, 0.8–2.5 mm diam. *Pseudobulbs* ovoid to ellipsoid, 0.3–5.5 cm apart, 0.3–5 by 0.15–0.6 cm, somewhat flattened or not. *Petiole* 1–9 mm. *Leaf blade* ovate to elliptic, 0.5–8.5 by 0.2–3.6 cm, index 2.3–12, tip acute. *Inflorescence* 0.6–7 cm, 2–9-flowered. *Peduncle* 0.3–1.4 cm; bracts c. 3, the longest 1.8–6 mm. *Rachis* 0.2–4.8 cm. *Floral bracts* triangular, 1–3 mm, tip acute. *Pedicel and ovary* 1–2.5 mm, with the node 0.2–1 mm from the floral bract. *Flowers* widely opening. *Median sepal* ovate to elliptic, 1–3.6 by 0.7–1.5 mm, index 1.3–3.5, tip short or long acuminate; rather thick; approx. glabrous. *Lateral sepals* free, 1.5–4.8 by 0.8–2.5 mm, index 1.3–3.9; otherwise as the median sepal. *Petals* elliptic to obovate, 0.6–1.5 by 0.3–1 mm, index 1.4–3, tip rounded to subacute; margins and adaxial surface often papillose towards the tip; thin. *Lip* approx. straight, general outline orbicular to (ob)ovate to (transversely) elliptic, 0.4–1.2 by 0.4–1 mm, index 0.7–1.8 (not spread), tip truncate to rounded; approx. glabrous to finely papillose; thick; adx. with a distinct basal concavity, basal teeth converging, together forming a transverse ridge with a deep slit half-way, top part of the lip also distinctly concave; abx. without a median ridge. *Column* from ovary to the tip of the rostellum 0.2–0.8 mm; rostellum protruding; stigma approx. orbicular, protruding at its base; column-foot with a distinct, rounded central knob above the attachment of the lip.

*Stelidia* absent or inconspicuous, if present deltoid, tip obtuse to acute. *Anther* abx. with a ridge; front margin not protruding.

Notes – 1. The differences from *Bulbophyllum gyaloglossum* are given under the latter species.

2. *Bulbophyllum savaiense* is variable. Mainly based on the size of the inflorescence as well as some flower parts 3 subspecies can be distinguished. One of these, subsp. *savaiense*, has a range far outside that of the other two. Subsp. *gorumense* and subsp. *subcubicum* seemingly have overlapping geographical ranges. However, a distinct separation between the two exists in altitudinal range: the first occurs at 2300–3400 m asl., the last at 0–2000 m asl.

#### KEY TO THE SUBSPECIES

- 1a. Most inflorescences shorter than 16 mm ..... c. subsp. *subcubicum*  
b. Most inflorescences 16 mm or longer ..... 2
- 2a. Lateral sepals 2.5–4.8 mm long (Rhizomes up to 70 cm long)  
b. subsp. *gorumense*  
b. Lateral sepals 1–2 mm long (Rhizomes generally not longer than 10 cm)  
a. subsp. *savaiense*

a. subsp. *savaiense* – Fig. 95a–f.

*Bulbophyllum savaiense* Schltr., Fedde, Rep. 9 (1911) 106. — Type: Vaupel 596 (holo B, †). Neotype: RSNH (Raynal) 16239 (holo P; iso K).

*Rhizome* up to 10 cm long. *Pseudobulbs* 0.7–1.1 cm long. *Leaf blade* 1.2–2.4 cm long. *Inflorescence* 2.5–7 cm long, 4–8-flowered. *Median sepal* 1–2 mm long, index 1.3–1.6. *Lateral sepals* 1–2 mm long, index 1.8–2. *Petals* 0.9–1 mm long, index 3–4. *Lip* 0.6–0.8 by 0.8–1 mm, index c. 0.7.

Colours – Flowers white.

Ecology – Epiphyte in primary forest. Alt. 300–700 m asl. Flowering observed in 2, 8.

Distribution – VANUATU. Erromango; Pentecost. – FIJI ISLANDS. Viti Levu; Vanua Levu; Taveuni. – SAMOA. Savaii; Ta’u; Olosega.

Note – Among the subspecies of *Bulbophyllum savaiense* characterized by the combination of a comparatively long inflorescence with small flowers.

b. subsp. *gorumense* (Schltr.) J.J. Vermeulen, *stat. nov.* – Fig. 96.

*Bulbophyllum gorumense* Schltr., Fedde, Rep. Beih. 1 (1913) 863; 21 (1928) f. 1153. — Type: Schlechter 18826 (B, †). Neotype: Hoogland 9566 (AMES, BM, BO, CANB, K, L, NY).

*Bulbophyllum bolaninum* Schltr., Fedde, Rep. 16 (1919) 218. — Type: Keysser 6 (holo B, †; iso BM).

*Rhizome* up to 70 cm long. *Pseudobulbs* 1.3–5 cm long. *Leaf blade* 2.5–8.5 cm long. *Inflorescence* 1.5–4.5 cm long, 4–9-flowered. *Median sepal* 2–3.6 mm long, index 1.6–3.5. *Lateral sepals* 2.5–4.8 mm long, index 2–3.9. *Petals* 1–1.5 mm long, index 1.4–2.4. *Lip* 0.7–1.2 by 0.5–1 mm, index 1–1.8.

Colours – Sepals and petals pale green, yellow, cream-coloured or white. Lip white, cream-coloured, yellow, orange or red.

Ecology – Epiphyte in primary forest. Also found as a terrestrial. Alt. 2300–3400 m asl. Flowering 3–5, 7–9.

Distribution – INDONESIA & PAPUA NEW GUINEA. New Guinea (central mountain range: Star Mts; from Bismarck Ra. to Milne Bay Prov. Also Saruwaged Mts; Huon Peninsula).

Notes – 1. Among the subspecies of *Bulbophyllum savaiense* characterized by the combination of a comparatively long inflorescence with large flowers.

2. Most specimens are as the illustrated one: with long and narrow leaves. However, plants with distinctly wider leaves (up to 36 mm wide) also occur.

c. subsp. **subcubicum** (J.J. Smith) J.J. Vermeulen, *stat. nov.* – Fig. 95g–k; Plate 5a.

*Bulbophyllum subcubicum* J.J. Smith, Nova Guinea 12, 1 (prob. May 1913) 86. — Syntypes: Cult. hort. BO 442 R (Rachmat) (lecto BO; isolecto L); Cult. hort. BO 287 B (Branderhorst) (BO, L).

*Bulbophyllum foveatum* Schltr., Fedde, Rep. Beih. 1 (May 1913) 859; 21 (1928) f. 1144. — Type: Schlechter 20187 (B, †).

*Bulbophyllum quadratum* Schltr., Fedde, Rep. Beih. 1 (May 1913) 859; 21 (1928) f. 1145. — Type: Schlechter 17574 (holo B, †; iso K, BM).

? *Bulbophyllum microtatanthum* Schltr., Fedde, Rep. Beih. 1 (1913) 870; 21 (1928) f. 1167. — Type: Schlechter 18273 (B, †).

*Bulbophyllum subcubicum* J.J. Smith var. *coccineum* J.J. Smith, Nova Guinea 12, 4 (1916) 398. — Type: Cult. hort. BO 264 (Gjellerup) (BO).

*Bulbophyllum philippinense* Ames, Orch. 6 (1920) 303. — Type: Wenzel 659 (AMES, NY).

*Rhizome* up to 40 cm long. *Pseudobulbs* 0.9–2 cm long. *Leaf blade* 1.1–6 cm long. *Inflorescence* 0.6–1.6 cm long, 2–6-flowered. *Median sepal* 1–2 mm long, index 1.5–2.2. *Lateral sepals* 1.5–2.4 mm long, index 1.3–2.3. *Petals* 0.6–1.3 mm long, index 1.6–3.3. *Lip* 0.4–0.9 by 0.4–0.9 mm, index c. 0.7–1.6.

Colours – Sepals and petals greenish, yellowish or white; also pinkish. Lip whitish, yellow, orange or red.

Ecology – Epiphyte in primary forest. Alt. 0–2000 m asl. Flowering 7–12.

Distribution – PHILIPPINES. Leyte. – INDONESIA & PAPUA NEW GUINEA. Sulawesi; Kalimantan (K. Timur, sterile specimens cultivated in hort. Leiden); New Guinea (widespread but from scattered localities, not in the Cendrawasih Peninsula); Manus Isl.

Notes – 1. Among the subspecies of *Bulbophyllum savaiense* characterized by the combination of a comparatively short inflorescence with small flowers.

2. The type of *Bulbophyllum microtatanthum* is lost. According to Schlechter's description it has inflorescences of up to 1.8 cm long, approaching subsp. *savaiense* in this aspect. However, the plant has been found far outside the presently known range of subsp. *savaiense*. Therefore *B. microtatanthum* is only provisionally included here.

**67. *Bulbophyllum simile* Schltr. – Fig. 97.**

*Bulbophyllum simile* Schltr., Fedde, Rep. Beih. 1 (1913) 858; 21 (1928) f. 1142. — Type: Schlechter 18770 (holo B, †; iso AMES).

*Bulbophyllum erythrochilum* Schltr., Fedde, Rep. Beih. 1 (1913) 856; 21 (1928) f. 1138. — Type: Schlechter 17353 (B, †).

*Rhizome* patent to pendulous, up to 25 cm long, 0.6–1.2 mm diam. *Pseudobulbs* (ob)ovoid, ellipsoid, or globular, 0.4–3 cm apart, 0.2–1.2 by 0.2–0.4 cm, not or hardly flattened. *Petiole* 0.5–0.8 mm. *Leaf blade* ovate to elliptic, 0.4–3.2 by 0.1–0.5 cm, index 3.5–8, tip acute to acuminate. *Inflorescence* 0.35–0.5 cm, 1-flowered. *Peduncle* 0.1–0.2 cm; bracts 1, 1.5–2.8 mm. *Floral bracts* tubular, 1–2 mm, tip obtuse. *Pedicel and ovary* 0.8–1.5 mm, with the node 0.2–0.6 mm from the floral bract. *Flowers* moderately opening. *Median sepal* ovate to elliptic, 1.5–2.2 by 0.6–0.9 mm, index 2.1–2.5, tip subacute to acuminate; rather thin; glabrous. *Lateral sepals* free, oblique 1.4–2.8 by 0.5–0.9 mm, index 2–5.8; otherwise as the median sepal. *Petals* obovate, sometimes approx. clawed, 0.9–1.2 by 0.3–0.8 mm, index 1.2–3, tip rounded to obtuse; margins sometimes finely papillose and/or erose; rather thin; adx. glabrous or finely papillose; abx. glabrous. *Lip* approx. straight, general outline (ob)ovate, 0.8–1 by 0.4–0.5 mm, index 1.6–2.3 (not spread), tip rounded; very thick and solid; glabrous or finely to coarsely papillose towards the tip; adx. with a basal concavity, basal teeth converging, together forming a transverse ridge with a notch half-way, basal part of the lip somewhat concave, gradually passing into the convex top part of the lip; abx. approx. without a median ridge. *Column* from ovary to the tip of the stolidia 0.2–0.4 mm; rostellum not protruding; stigma elliptic, not or hardly protruding at its base; column-foot with a rounded central knob above the attachment of the lip. *Stolidia* triangular, tip obtuse to acute; with or without an inconspicuous, rounded, wing along the lower margin. *Anther* abx. with a ridge; front margin somewhat protruding.

Colours – Sepals and petals white, pale yellow or pale greenish. Lip yellow, orange, red, brown or very dark green.

Ecology – Epiphyte in primary forest. Alt. 1000–2800 m asl. Flowering observed in 2, 4, 7, 10, 11.

Distribution – INDONESIA & PAPUA NEW GUINEA. New Guinea (central mountain range: scattered localities from Sudirman Ra. to Owen Stanley Ra. Also Finisterre Mts; Huon Peninsula).

Note – Well characterized by the combination of the 1-flowered inflorescence and the thick, solid lip.

## 68. *Bulbophyllum stipulaceum* Schltr. – Fig. 98.

*Bulbophyllum stipulaceum* Schltr. in Schum. & Laut., Nachtr. (1905) 217; Fedde, Rep. Beih. 1 (1913) 856; 21 (1928) f. 1136. — Type: Schlechter 13993 (holo B, †; iso BM, K, P).

*Bulbophyllum absconditum* J.J. Smith var. *neoguineense* J.J. Smith, Nova Guinea 8, 1 (1911) 88. — *Bulbophyllum pelma* J.J. Smith, Bull. Jard. Bot. Buitenzorg II, 3 (1912) 66. — Type: Versteeg 1514 (holo BO; iso AMES, K, L, P, U).

*Bulbophyllum absconditum* J.J. Smith var. *gautierense* J.J. Smith, Nova Guinea 12, 4 (1916) 397. — Type: Gjellerup 883 (holo BO; iso L).

Non *Bulbophyllum neoguineense* J.J. Smith, Bull. Dép. Agr. Ind. Néerl. 19 (1908) 7 (= sect. *Leptopus*); nec *B. gautierense* J.J. Smith, Fedde, Rep. 11 (1912) 133 (= sect. *Polyblepharon*).

*Rhizome* patent or pendulous, up to 25 cm long, 0.5–1.2 mm diam. *Pseudobulbs* (ob)ovoid, ellipsoid or globular, 0.3–1.8 cm apart, 0.2–0.4 by 0.15–0.3 cm, not or hardly flattened. *Petiole* 0.5–1 mm. *Leaf blade* ovate to elliptic, 0.6–0.5 by 0.1–0.3 cm, index 3.6–10, tip acuminate. *Inflorescence* 0.3–0.5 cm, 1-flowered. *Peduncle* 0.1–0.25 cm; bracts 1, 1.5–2.5 mm. *Floral bracts* tubular, 1–2.5 mm, tip acuminate. *Pedicel and*

ovary 0.5–1 mm, with the node 0.1–0.3 mm from the floral bract. *Flowers* widely opening. *Median sepal* ovate, 1.5–2 by 0.6–1.3 mm, index 1.3–2.5, tip obtuse to acuminate; rather thin; glabrous. *Lateral sepals* free, oblique, 1.3–2 by 0.4–1 mm, index 1.5–3.3; otherwise as the median sepal. *Petals* distinctly oblique, obovate, with an inconspicuous to very distinct (sometimes projecting far beyond the actual tip of the petal) winglike, rounded to subacute projection along the lower margin, 0.25–0.6 by 0.3–0.6 mm (the length measured along the midvein, ignoring the wing along the lower margin; the width measured perpendicularly on the length), index 0.6–1.2, tip obtuse; thin; glabrous. *Lip* approx. straight, general outline approx. hastate, constricted approx. half-way with the top part projecting, 0.5–0.8 by 0.4–0.5 mm, index 1.4–2 (not spread), tip obtuse to acute; rather thick, thinner towards the tip; glabrous; adx. with a distinct basal concavity, basal teeth converging, together forming a transverse ridge, with a notch half-way, basal part of the lip concave, gradually passing into the approx. flat top part of the lip; abx. without a median ridge. *Column* from ovary to the tip of the rostellum 0.25–0.4 mm; rostellum distinctly protruding; stigma ovate, not or hardly protruding at its base; column-foot with a distinct, rounded central knob above the attachment of the lip. *Stelidia* absent or inconspicuous, if present deltoid, tip obtuse. *Anther* abx. with a ridge towards its base; front somewhat protruding.

Colours – Flowers entirely pale yellow or pale greenish.

Ecology – Epiphyte in primary forest. Alt. 100–2500 m asl. Flowering 1, 2, 6–11.

Distribution – INDONESIA & PAPUA NEW GUINEA. New Guinea (widespread but not in Cendrawasih Peninsula and the southern lowlands).

Notes – 1. Differs from *Bulbophyllum absconditum* in the general outline of the lip: distinctly constricted approx. half-way and with a projecting, tongue-shaped top part. In *B. absconditum* subsp. *absconditum* the lip is either not, or only very slightly constricted half-way. It is slightly more so in subsp. *hastula*, but then the constriction is just beyond the widest part of the lip, and the top part is not truly projecting. The petals of *B. stipulaceum* are also different, they are wider and more distinctly oblique.

2. *Bulbophyllum stipulaceum* is variable in several aspects. The leaves are usually flat and rather thin, but in some specimens they are very thick and almost semi-terete. A wing-like projection occurs along the lower margins of the petals, in some specimens this is almost absent, whereas in others it is very large and projecting far beyond the tip of the petals.

## 69. *Bulbophyllum tanystiche* J.J. Vermeulen, *spec. nov.* – Fig. 99.

*Bulbophyllum tanystiche* in sect. *Pelmate* a labello axialiter bicarinato insigniter proprium. — Typus: Reeve 777 (holo K, iso L).

*Rhizome* pendulous, up to 25 cm long, c. 2.5 mm diam. *Pseudobulbs* ellipsoid to obovoid, 2–5.5 cm apart, 1.5–2.2 by 0.5–0.6 cm, (?) somewhat flattened. *Petiole* 4–7 mm. *Leaf blade* ovate to elliptic, 4.5–8 by 1.1–1.9 cm, index 4–4.5, tip acute. *Inflorescence* 3.5–7.5 cm, 10–30-flowered. *Peduncle* 1–1.5 cm; bracts 3–4, the longest 5–6 mm. *Rachis* 2.5–6.5 cm. *Floral bracts* ovate, 1.2–2 mm, tip acute. *Pedicel and ovary* 1.3–1.5 mm, with the node c. 0.3 mm from the floral bract. *Flowers* moderately opening. *Median sepal* ovate, c. 2.8 by 1 mm, index c. 2.8, tip acute; thick; glabrous. *Lateral sepals* free, c. 3.2 by 1 mm, index c. 3.2; otherwise as the median sepal. *Petals* obovate-spathulate, c. 1.1 by 0.7 mm, index c. 1.6, tip rounded; margins and adx. surface papillose to-

wards the tip; thin. *Lip* slightly curved, general outline elliptic, c. 1.4 by 0.7 mm, index 2 (not spread), tip rounded; margins finely papillose; thick; surface papillose towards the margins; adx. with a basal concavity, basal teeth converging, together forming a transverse ridge with a notch half-way, top part of the lip convex, with two obtuse longitudinal, parallel ridges; abx. approx. without a median ridge. *Column* from ovary to the tip of the stelia c. 0.5 mm; rostellum not protruding; stigma approx. orbicular, slightly protruding at its base; column-foot with an incurved, rounded central knob above the attachment of the lip. *Stelidia* inconspicuous, turned upwards, approx. triangular, tip acute; margins papillose. *Anther* abx. with a wide ridge; front margin slightly protruding.

Colours – Sepals and petals white, lip orange-red (?).

Ecology – Epiphyte. Alt. c. 1800 m asl. Flowering 7 (all from one record).

Distribution – PAPUA NEW GUINEA. New Guinea (central mountain range: Southern Highlands Prov.).

Notes – 1. Well characterized by the two longitudinal, parallel ridges on the adaxial side of the lip.

2. The name has been derived from the Greek 'tanyo', to stretch, and 'stichos', row, referring to the long, many-flowered inflorescences.

## 70. *Bulbophyllum xanthochlamys* Schltr. – Fig. 100.

*Bulbophyllum xanthochlamys* Schltr., Fedde, Rep. Beih. 1 (May 1913) 864; 21 (1928) f. 1155. — Type: Schlechter 19844 (holo B, †; iso AMES, BO).

*Bulbophyllum unigibbum* J.J. Smith, Fedde, Rep. 12 (Sept. 1913) 404; Nova Guinea 12, 4 (1916) 398. — Type: Gjellerup 1114 (BO, L).

*Bulbophyllum lamprochlamys* Schltr., Bot. Jahrb. 58 (1923) 195. — Type: Ledermann 11454 (B, †).

*Rhizome* pendulous, up to 45 cm long, 2–6 mm diam. *Pseudobulbs* ovoid to cylindrical, 1–7 cm apart, 0.5–6 by 0.3–0.8 cm, either flattened or not. *Petiole* 1–8 mm. *Leaf blade* ovate to elliptic, 1.2–12 by 0.6–4.2 cm, index 2–4.2, tip acute. *Inflorescence* 1.3–5.5 cm, 3–10-flowered. *Peduncle* 0.4–1.2 cm; bracts 2–4, the longest 5–7 mm. *Rachis* 0.9–4.5 cm. *Floral bracts* ovate, triangular, 1.8–7 mm, tip acute. *Pedicel and ovary* 2.5–3.5 mm, with the node 1.2–2 mm from the floral bract. *Flowers* moderately opening. *Median sepal* ovate to elliptic, 2.5–4.5 by 0.8–1.5 mm, index 2.3–3, tip short acuminate; rather thick; glabrous. *Lateral sepals* free, ovate, 2.5–5.5 by 0.8–1.5 mm, index 2.3–3.8; otherwise as the median sepal. *Petals* obovate, 1.5–2.4 by 0.7–1 mm, index 2–2.4, tip obtuse to subacute; margins somewhat papillose towards the tip; rather thin; surface glabrous. *Lip* slightly curved, general outline ovate to subrectangular, 1–2.2 by 0.5–1 mm, index 2–2.6 (not spread), tip obtuse to subacute; margins and surface papillose towards the tip; thick; adx. with a basal concavity, basal teeth converging, together forming a transverse ridge, basal part of the lip slightly concave, passing with an obtuse median knob into the slightly concave top part of the lip; abx. without a median ridge. *Column* from ovary to the tip of the stelia 0.5–1 mm; rostellum not protruding; stigma approx. orbicular, slightly protruding at its base or not; column-foot with a rounded central knob above the attachment of the lip. *Stelidia* inconspicuous, triangular, tip acute. *Anther* abx. with a wide ridge towards its base; front margin not protruding.

Colours – Sepals and petals white to greenish yellow. Lip white to orange red.



Ecology – Epiphyte in primary forest. Also found as a terrestrial in mossy shrub vegetation. Alt. 900–1900 m asl. Flowering observed in 1, 3, 4, 6.

Distribution – INDONESIA & PAPUA NEW GUINEA. New Guinea (central mountain range, scattered localities from Sudirman Ra. to Owen Stanley Ra. Also Cendrawasih Peninsula).

Notes – 1. The differences from *Bulbophyllum mesodon* are given in the notes under the latter.

2. The pseudobulbs may be much longer and narrower than in the illustrated specimen.

3. The specimen Eyma 4785 (the only one from the Cendrawasih Peninsula) is distinctly smaller in all vegetative parts than the other specimens, but otherwise not different.

### Section *Peltopus*

*Bulbophyllum* section *Peltopus* Schltr., Fedde, Rep. Beih. 1 (1913) 700 & 760. — Type species: *Bulbophyllum peltopus* Schltr.

*Bulbophyllum* section *Cycloglossum* Schltr., Fedde, Rep. Beih. 1 (1913) 705 & 883. — Lectotype species: *Bulbophyllum cycloglossum* Schltr. (the other syntype species, *B. nemorosum* Schltr. and *B. nubigenum* Schltr., both included by Schlechter in sect. *Cycloglossum*, are probably sect. *Fruticicola*).

*Rhizome* creeping, rarely patent to pendulous (*calviverter*, *subapetalum*, *thelantyx*); rhizome scales longer than the internodes they cover, rarely much shorter (*subapetalum*). *Roots* either sprouting along the entire rhizome, or below the pseudobulbs only; in case the rhizome is not creeping, the roots are sprouting from the older parts of the rhizome only. *Inflorescence* with 1 flower. *Median sepal*: tip subacute to caudate. *Petals* very small and inconspicuous (large and distinct in *discolor*, *intersitum*, *loroglossum*, *peltopus*). *Lip* not divided into lobes; with an inconspicuous to distinct concavity immediately above the ligament (not in *cycloglossum*, *origami*, *ortalis*); immediately in front of this concavity two converging teeth which together form a transverse ridge (not in *cycloglossum*, *kenae*). *Column*: rostellum distinctly protruding as a beaklike structure in lateral view; base of the stigma protruding in lateral view or not, but without teeth; column-foot with a thick median knob immediately above the ligament which fits into the basal concavity of the lip (absent or very inconspicuous in *cycloglossum*, *scutiferum*). *Stelidia* absent, lateral margins of the stigma without a tooth. *Pollinia* 4, the inner pair more than half as long as the outer pair. *Stipes* present.

Notes – 1. Section *Peltopus* is well characterized by the following polythetic set: Rhizome creeping; petals very small and inconspicuous; lip with a concavity near its base, in which fits a lump on the column-foot; stelidia absent; rostellum drawn out in a beaklike structure. Vegetatively many species look rather alike; the flowers, however, display a diversity of unique structures.

2. *Bulbophyllum cycloglossum* lacks the characteristic structures at the base of the lip and on the column-foot. It was placed in a separate section, *Cycloglossum*, by Schlechter. However, the absence of stelidia and the shape of the rostellum leave no doubt that it belongs in sect. *Peltopus*. The other two species included in sect. *Cycloglossum* by Schlechter, *B. nemorosum* Schltr. and *B. nubigenum* Schltr. do have stelidia and are better included in sect. *Fruticicola*.

3. To describe the structure of the lip, the same terminology has been applied as in sect. *Pelma* (see Fig. 23 on page 121). Improper use of the terminology may lead to misunderstandings when using the key as well as the descriptions.

4. Diagnostic structures on the lip are often invisible in decayed or excessively shrivelled or flattened herbarium material. Such specimens can hardly be identified with this key. In some cases it may help to soak the flower in warm, strong ammonia or in a ditto NaOH-solution.

5. In many species of this section the shape of the petals is highly variable.

#### KEY TO THE SPECIES OF SECTION PELTOPUS

- 1a. Lip shorter than 7 mm ..... 2
- b. Lip 7 mm or longer ..... 27
- 2a. Basal part of the lip with a distinct, high, obtuse median ridge, which projects backwards far beyond the ligament. Basal concavity no more than a shallow impression on this ridge ..... 3
- b. Basal part of the lip without a high median ridge; or basal part of the lip with a median ridge or callus which does not or hardly projects backwards, but then a distinct basal concavity is also present ..... 4
- 3a. Median sepal with a short acuminate tip. Lip sharply folded backwards approx. half-way, so that the top part of the lip touches the basal part again ... **90. B. origami**
- b. Median sepal with a long acuminate tip. Lip distinctly curved half-way, but not so sharply folded that top and base touch again ..... **91. B. ortalis**
- 4a. (2) Rhizome patent or pendulous. Lip concave towards its base. Roots only sprouting from the older parts of the rhizome, usually creeping downwards along the rhizome, towards the substratum ..... 5
- b. Rhizome creeping; or rhizome occasionally slightly patent towards the most recently developed parts, but then the lip flat or convex towards the base. Roots usually sprouting along the entire rhizome, even from the most recently developed parts, growing away from the rhizome towards the substratum ..... 7
- 5a. Pseudobulbs distinctly shorter than the adjoining portions of the rhizome. Lip at the tip with a thick, obtuse appendage of 0.8–1.5 mm long .. **100. B. subapetalum**
- b. Pseudobulbs distinctly longer than the adjoining portions of the rhizome. Lip rounded to acute at the tip, without an appendage. .... 6
- 6a. Index median sepal 1.8–2.6; tip acute to shortly acuminate. Lip concave from base to tip ..... **102. B. thelantyx**
- b. Index median sepal 4.6–10.5; tip long acuminate to caudate. Lip concave towards the base, distinctly convex towards the tip ..... **79. B. calviverter**
- 7a. (4) Knob on the column-foot moderately to distinctly pointing upwards: the face of the column-foot, immediately above the knob, is distinctly concave in lateral view (see Fig. 25a, b, c) ..... 8

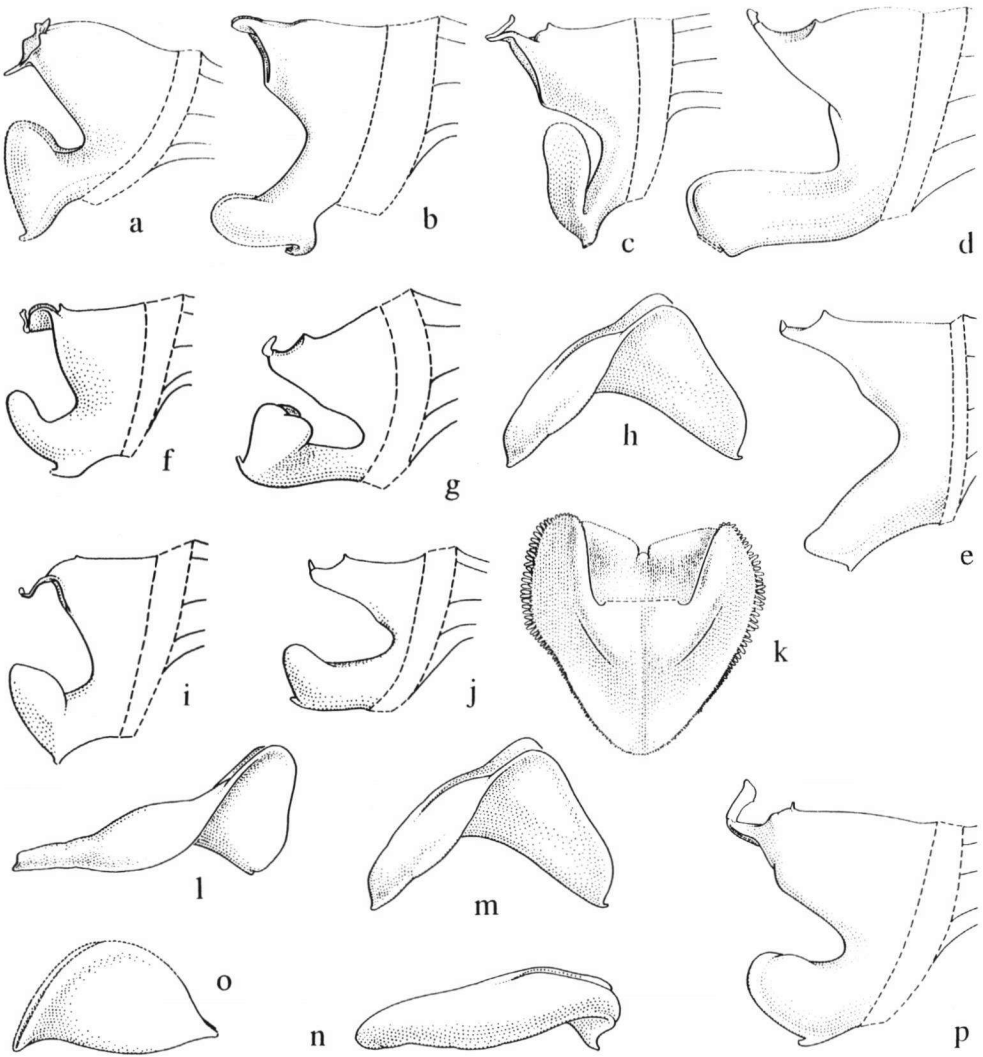

Fig. 25. Explanatory sketches with the key to the species of *Bulbophyllum* sect. *Peltopus*.

- b. Knob on the column-foot straight or very slightly pointing upwards: the face of the column-foot, immediately above the knob, is approx. flat or very slightly concave in lateral view (see Fig. 25d, e) . . . . . 20
- 8a. Basal part of the lip flat or convex . . . . . 9
- b. Basal part of the lip slightly to distinctly concave in between the upturned margins 12
- 9a. Pseudobulbs 0.8–2 cm long; leaves 0.8–1.5 cm wide (check a fully developed, flowering portion of the plant). . . . . 10
- b. Pseudobulbs 0.3–1.1 cm long; leaves 0.2–0.7 mm wide . . . . . 11

- 10a. Lip c. 2.3 mm long ..... 98. *B. santoense*  
 b. Lip 3.5–6.5 mm long ..... 89. *B. octarrhenipetalum*
- 11a. (9) Index of the lip 0.8–1.5 (do not spread the lip artificially) ... 81. *B. discolor*  
 b. Index of the lip 1.8–2.9 ..... 84. *B. intersitum*
- 12a. (8) Index of the median sepal more than 3 ..... 13  
 b. Index of the median sepal 1.6–3 ..... 15
- 13a. Margins at the base of the lip distinctly curved upwards, protruding as two thin wings with sharp edges ..... 77. *B. brachypetalum*  
 b. Margins at the base of the lip somewhat curved upwards, fleshy and obtuse, not protruding as thin wings ..... 14
- 14a. Knob on column-foot high in lateral view (see Fig. 25f). Leaves in flowering portion of the plant 0.7–3 cm wide. Lip 4–6 mm long, index 0.9–2 (do not spread artificially) (flowers without purple markings) ..... 88. *B. minutipetalum*  
 b. Knob on column-foot low in lateral view (see Fig. 25g). Leaves in flowering portion of the plant 0.5–1.3 cm wide. Lip 5.8–7 mm long, index 1.9–2.8 (do not spread artificially) (flowers with purple markings) ..... 79. *B. calviverter*
- 15a. (12) Margins of the top part of the lip approx. glabrous ..... 16  
 b. Margins of the top part of the lip finely but distinctly papillose or shortly ciliate . 19
- 16a. Pseudobulbs 1.5–3 cm apart in flowering portions of the plant. Lip distinctly curved approx. half-way (see Fig. 25h) ..... 76. *B. bliteum*  
 b. Pseudobulbs 0.2–0.8 cm apart in flowering portions of the plant. Lip approx. straight or slightly curved in the basal half ..... 17
- 17a. Column foot distinctly pointing upwards (see Fig. 25i) 89. *B. octarrhenipetalum*  
 b. Column foot moderately pointing upwards (see Fig. 25j). ..... 18
- 18a. Top part of the lip convex, margins not turned upwards . 74. *B. aphanopetalum*  
 b. Top part of the lip flat or slightly concave due to the turned upwards margins  
 75. *B. artostigma*
- 19a. (15) Median sepal c. 4 mm long. Lip in the basal half with the margins sharply folded upwards, in lateral view visible as two projecting, more or less sharp conical points  
 94. *B. plicatum*  
 b. Median sepal 6–37 mm long. Lip in the basal half with the margins curved upwards, but not upwards projecting as two sharp, conical points 89. *B. octarrhenipetalum*
- 20a. (7) Index lip more than 2.2 (do not spread the lip artificially) ..... 21  
 b. Index lip 2.2 or less ..... 23
- 21a. Lip adx. with a high, sharply outlined, approx. box-shaped callus immediately above the basal concavity ..... 83. *B. inciferum*  
 b. Lip continuing concave above the basal concavity, no box-shaped callus present 22
- 22a. Lip abx. with long hairs towards the margins ..... 85. *B. kenae*  
 b. Lip abx. glabrous or finely papillose towards the margins ..... 78. *B. brassii*

- 23a. (20) Basal concavity large and distinct (see Fig. 25k) . . . . . 81. *B. discolor*  
 b. Basal concavity absent, or small, sometimes inconspicuous . . . . . 24
- 24a. Lip in lateral view highest near its base (see Fig. 25 l) . . . . . 78. *B. brassii*  
 b. Lip in lateral view highest approx. half-way (see Fig. 25m, 25o), or approx. equally high over its entire length (see Fig. 25p) . . . . . 25
- 25a. Pseudobulbs in a flowering portion of the plant 1.2–1.7 cm long. Leaves 1.3–2.2 cm wide. Lip distinctly curved approx. half-way . . . . . 76. *B. bliteum*  
 b. Pseudobulbs in a flowering portion of the plant 0.3–0.8 cm long. Leaves 0.1–0.5 cm wide. Lip not or hardly curved, or curved at the base . . . . . 26
- 26a. Lip 0.7–1 mm long. Leaves 0.1–0.3 mm wide . . . . . 80. *B. cycloglossum*  
 b. Lip 1.8–3 mm long. Leaves 0.25–0.5 mm wide . . . . . 99. *B. scutiferum*
- 27a. (1) Lip adx. either with a distinct, high, rounded to sharp longitudinal crest, or with a distinct, sharply outlined, approx. box-shaped callus near its base . . . . . 28  
 b. Lip adx. without a distinct longitudinal crest and without a distinct box-shaped callus near its base (at most an inconspicuous, flat callus may be present) . . . . . 30
- 28a. Lip adx. with a distinct, sharply outlined, approx. box-shaped callus near its base, which abruptly ends in front (Series A) . . . . . 83. *B. inciferum*  
 b. Lip adx. with a distinct, high crest over most of its length, gradually diminishing in height towards the tip of the lip . . . . . 29
- 29a. Median sepal 18–23 mm long. The top part of the lip distinctly verrucose . . . . . 86. *B. lophonon*  
 b. Median sepal 65–70 mm long. The top part of the lip may have a slightly irregular surface but is not truly verrucose . . . . . 82. *B. hiljeae*
- 30a. (27) Top part of the lip with the margins sharply folded over the adaxial side of the lip, and covering most of it . . . . . 31  
 b. Top part of the lip with the margins more or less flat, or with the margins recurved towards the abaxial side of the lip . . . . . 32
- 31a. Tip of the lip caudate, with a cauda 4.5–27 mm long . . . . . 96. *B. reevei*  
 b. Tip of the lip obtuse to subacute . . . . . 95. *B. ptychantyx*
- 32a. Lip with a long-acuminate to caudate tip . . . . . 33  
 b. Lip with a rounded to acute tip; or lip with a shortly and inconspicuously acuminate tip . . . . . 34
- 33a. Top part of the lip adx. with a small, low central callus, otherwise slightly convex, flat or concave. Lip 5–9 mm wide (do not spread artificially) . . . . 96. *B. reevei*  
 b. Top part of the lip adx. without a small central callus, distinctly convex. Lip 3.4–4.5 mm wide (do not spread artificially) . . . . . 101. *B. systemochilum*
- 34a. (32) Index of lip 4 or more (do not spread artificially) . . . . . 35  
 b. Index of lip 1–3.5 (do not spread artificially) . . . . . 36

- 35a. Lip 7–9 mm long, shorter than one half of the length of the sepals  
71. *B. aechmophorum*  
 b. Lip 16–21 mm long, longer than one half of the length of the sepals  
87. *B. loroglossum*
- 36a. (34) Index median sepal 1.3–2; tip (sub)acute . . . . . 37  
 b. Index median sepal 2.3–14; tip long acuminate to caudate . . . . . 38
- 37a. Lip 8–12.5 mm long, top part flat or entirely concave . . . . . 92. *B. patella*  
 b. Lip 3.5–6.5 mm long, top part entirely (slightly) convex, or slightly concave close to its base only . . . . . 89. *B. octarrhenipetalum*
- 38a. (36) Tip of the lip widely rounded. Lip approx. straight, widely concave in the basal half . . . . . 93. *B. peltopus*  
 b. *Either* tip of the lip obtuse to shortly acuminate; *or* tip of the lip rounded to obtuse, but then lip slightly curved at the base, and adx. approx. flat in front of the basal concavity . . . . . 39
- 39a. Knob on the column-foot straight: the face of the column-foot, immediately above the knob, is approx. flat (see Fig. 25d) . . . . . 40  
 b. Knob on the column-foot moderately (see Fig. 25p) to distinctly pointing upwards (see Fig. 25g): the face of the column-foot, immediately above the knob, is moderately to distinctly concave . . . . . 41
- 40a. Lip 4–7.5 mm wide. Most pseudobulbs longer than the adjoining portions of the rhizome . . . . . 97. *B. rhodoleucum*  
 b. Lip 1.8–3 mm wide. Most pseudobulbs as long as, or shorter than the adjoining portions of the rhizome . . . . . 78. *B. brassii*
- 41a. (39) Knob on the column foot moderately pointing upwards (see Fig. 25p)  
72. *B. alveatum*  
 b. Knob on the column foot distinctly pointing upwards (see Fig. 25g) . . . . . 42
- 42a. Basal part of the lip distinctly concave . . . . . 79. *B. calviverter*  
 b. Basal part of the lip not or hardly concave . . . . . 73. *B. ankylochele*

**71. *Bulbophyllum aechmophorum* J.J. Vermeulen, *spec. nov.* – Fig. 101.**

*Bulbophyllum aechmophorum* a *B. systemochilo* in labello plus minusve acuto parte distali multo minus distincte convexa differt. — Typus: Brass 11442 (AMES).

*Rhizome* creeping, 2–2.5 mm diam. *Pseudobulbs* ovoid, 0.4–1.8 cm apart, 1.2–2.5 by 0.5–0.9 cm, not or hardly flattened. *Petiole* 10–18 mm. *Leaf blade* elliptic to obovate, 3.5–6.2 by 0.7–1.7 cm, index 2.2–9, tip obtuse to acute. *Inflorescence* 8–12 cm, 1-flowered. *Peduncle* 3.8–4.5 cm; bracts c. 3, the longest 7–8 mm. *Floral bracts* tubular, 6–6.5 mm, tip acuminate. *Pedicel and ovary* 17–23 mm, with the node 3–4.5 mm from the floral bract. *Flowers* moderately opening. *Median sepal* ovate, 28–50 by 4.5–5 mm, index 6.2–10, tip caudate; thin; glabrous. *Lateral sepals* free, oblique, 30–48 by 5–5.5

mm, index 6–8.8; otherwise as the median sepal. *Petals* ovate, 0.3–0.9 by 0.8–1.2 mm, index 0.3–0.8, tip obtuse; thin; glabrous. *Lip* approx. straight, general outline approx. elliptic, narrowed in the basal half, and slightly tapering towards the tip, 7–9 by 1.5–1.8 mm, index 4–5 (not spread), tip subacute; thick; glabrous; adx. with a distinct basal concavity, basal teeth converging, together forming a transverse ridge, basal part of the lip distinctly convex, with a median furrow, gradually passing into the slightly convex or flat top part of the lip; abx. with a retuse median ridge. *Column* from ovary to the tip of the rostellum 2.5–3 mm; rostellum distinctly protruding; stigma obovate, slightly protruding at its base; column-foot with a distinct, approx. straight, rounded central knob above the attachment of the lip. *Anther* (not seen).

Colours – Pseudobulbs suffused brownish. Sepals pale green or yellow green, with more or less pinkish to dark purple veins, with or without a purple tip. Lip and column bright green.

Ecology – Epiphyte in primary forest. Alt. 1800–2900 m asl. Flowering recorded in 10, 11.

Distribution – INDONESIA & PAPUA NEW GUINEA. New Guinea (central mountain range, scattered localities from Sudirman Mts to Owen Stanley Ra.).

Notes – 1. Differs from *Bulbophyllum systemochilum* in having a subacute lip which has a much less distinctly convex top part.

2. The name has been derived from the Greek 'aichme', the point of a spear, referring to the shape of the lip.

## 72. *Bulbophyllum alveatum* J.J. Vermeulen, *spec. nov.* – Fig. 102.

*Bulbophyllum alveatum* a *B. rhodoleuco* in tuberculo incurvato columnae basi insidenti, a *B. ankylochele* labello breviter acuminato differt. — Typus: NGF 20362 (van Royen) (holo L; iso BRI, CANB, LAE).

*Rhizome* creeping, 1.8–3 mm diam. *Pseudobulbs* ovoid, 0.3–1 cm apart, 1.2–3.5 by 0.4–0.7 cm, not or hardly flattened. *Petiole* 10–28 mm. *Leaf blade* elliptic, 4–14 by 1–2.2 cm, index 2.3–10.5, tip acute to acuminate. *Inflorescence* 14–26 cm, 1-flowered. *Peduncle* 11–19 cm; bracts 3–4, the longest 5–8 mm. *Floral bracts* tubular, 4–6 mm, tip acuminate. *Pedicel and ovary* 18–33 mm, with the node 2–5 mm from the floral bract. *Flowers* moderately opening. *Median sepal* ovate, 26–45 by 4–5 mm, index 5.2–8.8, tip caudate; thin; glabrous. *Lateral sepals* free, oblique, 30–45 by 5–6.5 mm, index 4.6–8; otherwise as the median sepal. *Petals* ovate to triangular, 1–1.5 by 1–1.4 mm, index 0.8–1.3, tip obtuse; thin; glabrous. *Lip* slightly curved at the base, general outline elliptic to obovate, 9.5–13 by 3–5 mm, index 2–3.2 (not spread), tip sharply acute to shortly acuminate; rather thick; glabrous except for the sometimes slightly verrucose tip; adx. with a distinct basal concavity, basal teeth converging, not touching at the tip, together forming a transverse ridge, basal part of the lip not protruding far beyond the ligament, concave, gradually passing into the approx. flat top part of the lip; abx. without a median ridge. *Column* from ovary to the tip of the rostellum 3–3.5 mm; rostellum distinctly protruding; stigma obovate, slightly distinctly protruding at its base; column-foot with a distinct, moderately upwards pointing, rounded central knob above the attachment of the lip. *Anther* abx. with a wide ridge; front margin somewhat not protruding.

Colours – Peduncle and pedicel purple. Sepals white, with pink or purple tip and/or veins. Petals white. Lip white, (partly) suffused with purple towards the base.

Ecology – Epiphyte in primary forest. Alt. 1800–2000 m asl. Flowering observed in 1, 9.

Distribution – PAPUA NEW GUINEA. New Guinea (central mountain range: Wharton Ra.).

Notes – 1. Differs from *Bulbophyllum ankylochele* having an elliptic to obovate, sharply acute to shortly acuminate lip, which has a concave basal part. The lips of the two species are also different in lateral view: the basal part of the lip is projecting far beyond the ligament in *B. ankylochele*, while hardly so in *B. alveatum*. The differences from *B. rhodoleucum* as well as *B. brassii* are given under *B. ankylochele*; with *B. peltopus* under that species.

2. The name has been derived from the Latin 'alveatus', hollowed out, referring to the concave basal part of the lip.

### 73. *Bulbophyllum ankylochele* J.J. Vermeulen, *spec. nov.* – Fig. 103; Plate 5b.

*Bulbophyllum ankylochele* a *B. brassii* et *B. rhodoleuco* in tuberculo incurvato columnae basi insidenti, a *B. alveato* in labello ovato rotundato ad subacuto differt. — Typus: Reeve 1032 (holo L; iso K, E).

*Rhizome* creeping, 2–4 mm diam. *Pseudobulbs* ovoid, 0.5–2.5 cm apart, 1–6 by 0.5–1 cm, not or hardly flattened. *Petiole* 7–16 mm. *Leaf blade* elliptic, 6.5–16 by 0.9–2.8 cm, index 5.2–8.2, tip acute. *Inflorescence* 14–20 cm, 1-flowered. *Peduncle* 7–17 cm; bracts 3–4, the longest 6–10.5 mm. *Floral bracts* tubular, 5–8.5 mm, tip acuminate. *Pedicel and ovary* 25–33 mm, with the node 4–5 mm from the floral bract. *Flowers* widely opening. *Median sepal* ovate, 28–85 by 7–9 mm, index 3.7–9.5, tip caudate; thin; glabrous. *Lateral sepals* free, oblique, 26–85 by 5–10 mm, index 4–8.5, lower margin sometimes slightly papillose; otherwise as the median sepal. *Petals* ovate to triangular, 0.6–0.9 by 0.6–1.4 mm, index 0.6–1, tip obtuse to subacute; thin; glabrous. *Lip* slightly curved at the base, general outline ovate, 10–12 by 5.5–6 mm, index 1.6–2.2 (not spread), tip rounded to subacute; margins glabrous to papillose; rather thick; surface glabrous to finely papillose; adx. with a distinct basal concavity, basal teeth converging, not touching at the tip, together forming a transverse ridge, base of the lip protruding distinctly beyond the ligament, top part of the lip approx. flat or slightly convex; abx. without a median ridge. *Column* from ovary to the tip of the rostellum 2.8–4 mm; rostellum distinctly protruding; stigma orbicular, somewhat protruding at its base; column-foot with a distinct, distinctly upwards pointing, rounded central knob above the attachment of the lip. *Anther* abx. with a wide ridge towards its base; front margin not protruding.

Colours – Sepals white to creamy yellow. Lip dull yellow to bright orange.

Ecology – Epiphyte. Sometimes with a faint, sweetish, fungus-like scent. Alt. 1700–2300 m asl. Flowering observed in 2, 7, 10.

Distribution – INDONESIA & PAPUA NEW GUINEA. New Guinea (central mountain range from Sudirman Mts to the Western and Southern Highlands Prov.).

Notes – 1. *Bulbophyllum ankylochele* and *B. alveatum* differ from *B. rhodoleucum* as well as *B. brassii* in having a distinctly upwards pointing central knob on the column-foot: the face of the column-foot, immediately above the knob, is concave. The differences between *B. ankylochele* and *B. alveatum* as well as *B. peltopus* are given under those respective species.



2. The lip is approx. glabrous in some specimens, and may have a distinctly less rounded tip than the specimen illustrated.

3. The name has been derived from the Greek 'ankylos', hook, and 'chele', claw, referring to the strongly upwards pointing knob on the column-foot.

#### 74. *Bulbophyllum aphanopetalum* Schltr. – Fig. 104.

*Bulbophyllum aphanopetalum* Schltr. Bot. Jahrb. 39 (1906) 82. — Type: Schlechter 15598 (B, †). Neotype: Jongejan 3263 (leg. Villegente) (L).

*Cirrhopetalum capillipes* Guillaumin, Not. Syst. 10 (1941) 67. — *Bulbophyllum capillipes* (Guillaumin) Hallé, Bull. Mus. Hist. Nat. Paris sér. 3, Bot., 127 (1973) 23. — Type: Pancher s.n. (P).

Not *Bulbophyllum capillipes* Par. & Reichb. f., Trans. Linn. Soc. 30 (1874) 150.

*Rhizome* creeping, 1–1.5 mm diam. *Pseudobulbs* ovoid, 0.3–0.8 cm apart, 0.7–1.2 by 0.4–0.7 cm, not or hardly flattened. *Petiole* 2–4 mm. *Leaf blade* elliptic to obovate, 2–6 by 0.8–1.4 cm, index 2.5–6, tip acute. *Inflorescence* 4.5–7.5 cm, 1-flowered. *Peduncle* 3–6.5 cm; bracts 2–3, the longest 3–4.5 mm. *Floral bracts* tubular, 2.5–3 mm, tip acute. *Pedicel and ovary* 9.8–11 mm, with the node 2–2.5 mm from the floral bract. *Flowers* moderately opening. *Median sepal* ovate, 5–9 by 2–3.5 mm, index 2.5–2.6, tip acute to slightly acuminate; thin; glabrous. *Lateral sepals* oblique, 5–10 by 2–4 mm, index 2.3–2.6; otherwise as the median sepal. *Petals* (ob)ovate to triangular, 0.1–0.7 by 0.3–0.6 mm, index 0.3–1.2, tip rounded to shortly acuminate; thin; glabrous. *Lip* approx. straight or slightly curved at the base, general outline ovate, 2.5–4.5 by 1–2.7 mm, index 1.5–2.5 (not spread), tip obtuse to shortly acuminate; rather thick; glabrous; adx. with a distinct basal concavity, basal teeth converging, not touching at the tip, together forming a transverse ridge, basal part of the lip concave from margin to margin up to approx. half-way the lip, gradually passing into the slightly convex top part of the lip; abx. approx. without a median ridge. *Column* from ovary to the tip of the rostellum 1.2–1.8 mm; rostellum distinctly protruding; stigma approx. orbicular, protruding at its base; column-foot with a distinct, moderately upwards pointing, rounded central knob above the attachment of the lip. *Anther* abx. with a wide ridge; front margin not protruding.

Colours – Sepals and petals yellowish green to pale yellow. Lip yellow.

Ecology – Epiphyte in primary forest. Alt. 400–1000 m asl. Flowering 1–6, 9, 12.

Distribution – PAPUA NEW GUINEA. Karkar Isl. – NEW CALEDONIA. – FIJI ISLANDS. Viti Levu.

Note – The differences from *Bulbophyllum artostigma* and *B. bliteum* are given under those two species.

#### 75. *Bulbophyllum artostigma* J.J. Vermeulen, *spec. nov.* – Fig. 105.

*Bulbophyllum artostigma* a *B. aphanopetalum*, *B. bliteo*, *B. octarrhenipetalum* in labelli parte superiore plana ad parum concava ob margines verticalibus nec convexa differt. — Typus: Jongejan 1763 (L).

*Rhizome* creeping, 1–1.5 mm diam. *Pseudobulbs* ovoid, 0.4–0.8 cm apart, 0.7–1 by 0.4–0.7 cm, not or hardly flattened. *Petiole* 3–5 mm. *Leaf blade* elliptic, 1.7–3 by 0.8–1.3 cm, index 2.1–3, tip acute. *Inflorescence* c. 3.5 cm, 1-flowered. *Peduncle* c. 1.4 cm; bracts c. 3, the longest c. 3 mm. *Floral bracts* tubular, c. 2 mm, tip acute. *Pedicel and*

ovary c. 11 mm, with the node c. 1.5 mm from the floral bract. *Flowers* moderately opening. *Median sepal* ovate, c. 11.5 by 4 mm, index 2.8–3, tip long acuminate; thin; glabrous. *Lateral sepals* oblique, c. 11.5 by 4 mm, index 2.8–3; otherwise as the median sepal. *Petals* approx. elliptic, c. 1.2 by 0.8 mm, index c. 1.5, tip subacute, margins slightly erose; thin; surface glabrous. *Lip* somewhat curved, general outline ovate, c. 6 by 4.2 mm, index 1.4–1.5 (not spread), tip broadly rounded; rather thick; glabrous; adx. with a rather inconspicuous basal concavity, basal teeth converging, not touching at the tip and together forming a transverse ridge, basal part of the lip with a concavity around the basal teeth only, otherwise flat or slightly concave because of the upturned margins, gradually passing into the flat or slightly concave top part of the lip; abx. approx. without a median ridge. *Column* from ovary to the tip of the rostellum c. 1.8 mm; rostellum distinctly protruding; stigma narrowly ovate, slightly protruding at its base; column-foot with a distinct, slightly to moderately upwards pointing, rounded central knob above the attachment of the lip. *Anther* abx. with a wide ridge; front margin not protruding.

Colours – Sepals yellow with dark purple veins. Petals white with a purple vein. Lip ochre brown, paler towards the margins and yellow at the base.

Ecology – Unknown.

Distribution – PAPUA NEW GUINEA. New Guinea (exact locality unknown).

Notes – 1. *Bulbophyllum aphanopetalum*, *B. bliteum* as well as *B. octarrhenipetalum* differ in having a convex top part of the lip. The first two species also have a wider stigma.

2. The name has been derived from the Latin 'artus', narrow.

## 76. *Bulbophyllum bliteum* J.J. Vermeulen, *spec. nov.* – Fig. 106.

*Bulbophyllum bliteum* *B. aphanopetalum* simillimum a labello circa medio itinere distincte recurvato differt. — Typus: Jongejan 822 (L).

*Rhizome* creeping, 1.3–3 mm diam. *Pseudobulbs* ovoid to ellipsoid, or globose, 1.5–3 cm apart, 1.2–2.8 by 0.3–1.3 cm, not or hardly flattened. *Petiole* 4–15 mm. *Leaf blade* elliptic, 2.6–10.5 by 1.3–2.2 cm, index 2–7, tip acute. *Inflorescence* 3–4 cm, 1-flowered. *Peduncle* 0.5–3 cm; bracts c. 4, the longest 3–4 mm. *Floral bracts* tubular, 2.6–3 mm, tip obtuse to acute. *Pedicel and ovary* 8–10 mm, with the node 1.8–2 mm from the floral bract. *Flowers* widely opening. *Median sepal* ovate, 9–11 by 3–4 mm, index 2.2–3, tip acute to slightly acuminate; margins glabrous or finely papillose; thin; surface glabrous. *Lateral sepals* free, oblique, 9–10 by 3–4 mm, index 2.5–3.5, margins glabrous; otherwise as the median sepal. *Petals* ovate, 0.7–1 by 0.7–0.9 mm, index 0.7–1.4, tip acute; thin; glabrous. *Lip* distinctly curved approx. half-way, general outline ovate, 2.5–3.5 by 1.5–2 mm, index 1.5–2.9 (not spread), tip subacute; rather thick; glabrous; adx. with a rather inconspicuous basal concavity, basal teeth converging, together forming a transverse ridge with a deep slit half-way, basal part of the lip concave from margin to margin up to approx. half-way the lip, gradually passing into the slightly convex top part of the lip; abx. with a truncate median ridge. *Column* from ovary to the tip of the rostellum c. 1.3 mm; rostellum distinctly protruding; stigma approx. orbicular to elliptic, slightly protruding at its base; column-foot with a slightly to moderately upwards pointing, rounded central knob above the attachment of the lip. *Anther* abx. with an inconspicuous ridge; front margin not protruding.

Colours – Sepals and petals white or pale yellow, the petals sometimes with a purple tip and margins. Lip bright yellow, sometimes with purple along the margins.

Ecology – Epiphyte on shaded place. Alt. 2200–3000 m asl. Flowering observed in 5, 11.

Distribution – PAPUA NEW GUINEA. New Guinea (central mountain range: Western Highlands Prov.; Chimbu Prov.).

Notes – 1. *Bulbophyllum aphanopetalum* has a less distinctly recurved lip, and more closely placed pseudobulbs. *Bulbophyllum brassii* has longer sepals, a larger lip and a straight column-foot. The differences between *B. bliteum* and *B. artostigma* are given under the latter species.

2. The name is derived from the Latin 'bliteus', insipid or tasteless, because of the lack of outstanding features in this species.

### 77. *Bulbophyllum brachypetalum* Schltr. – Fig. 107.

*Bulbophyllum brachypetalum* Schltr., Fedde, Rep. Beih. 1 (1913) 762; 21 (1928) f. 964. — Type: Schlechter 19063 (B, †). Neotype: Cruttwell 3204 (L).

*Rhizome* creeping, 1–2 mm diam. *Pseudobulbs* ovoid, 0.2–1 cm apart, 1–2.5 by 0.2–0.5 cm, not or hardly flattened. *Petiole* 6–9 mm. *Leaf blade* elliptic to obovate, 2.2–8 by 0.4–1.3 cm, index 3.9–10, tip acute. *Inflorescence* 7–10.5 cm, 1-flowered. *Peduncle* 5–8 cm; bracts 2–3, the longest 5–6 mm. *Floral bracts* tubular, 3.5–6 mm, tip acuminate. *Pedicel and ovary* 11–23 mm, with the node 2.3–5 mm from the floral bract. *Flowers* moderately opening. *Median sepal* ovate, 9–38 by 2–6.5 mm, index 3.8–8, tip long acuminate to caudate; margins glabrous to finely ciliate; thin; adx. glabrous to pubescent (see note); abx. glabrous or papillose around the veins. *Lateral sepals* free, oblique, 10.5–44 by 2.8–6.5 mm, index 4.2–7.4; otherwise as the median sepal. *Petals* elliptic to triangular, 0.4–0.9 by 1.4–1.5 mm, index 0.3–1.8, tip rounded to acuminate; thin; glabrous. *Lip* approx. straight or slightly incurved, general outline ovate to triangular, often slightly tapering towards the tip, 3.8–6.5 by 1.8–2.5 mm, index 1.9–2.6 (not spread), tip sub-acute; margins glabrous; thick; adx. with a distinct basal concavity, basal teeth converging, together forming a transverse ridge with a deep notch half-way, basal part of the lip not protruding beyond the ligament, distinctly concave, upwards curved margins thin and with sharp edges, gradually passing into the flat or slightly convex top part of the lip, entire surface glabrous; abx. with an inconspicuous, truncate median ridge, surface almost glabrous to papillose or pilose. *Column* from ovary to the tip of the rostellum 1.2–2.5 mm; rostellum distinctly protruding; stigma orbicular, somewhat protruding at its base; column-foot with a distinct, distinctly upwards pointing, rounded central knob above the attachment of the lip. *Anther* abx. with a wide ridge; front margin hardly protruding.

Colours – Sepals white or cream-coloured, with pink or purple veins or not, or entirely purple. Petals hyaline, lip cream-coloured, yellow, or brownish, often with purple veins, or entirely purple.

Ecology – Epiphyte in primary forest. Also observed in a native garden. Alt. 1700–3300 m asl. Flowering observed in 1, 7, 9, 12.

Distribution – PAPUA NEW GUINEA. New Guinea (central mountain range from Western and Southern Highlands Prov. to Owen Stanley Ra. Also Huon Peninsula).

Notes – 1. Differs from *Bulbophyllum minutipetalum* and *B. calviverter* in having a lip with the margins protruding upwards as thin, sharp-edged wings towards its base. Besides, the lip is entirely glabrous adaxially, in particular around the basal teeth.

2. According to Schlechter, the type specimen of *B. brachypetalum* (not seen) has the sepals pubescent adaxially. This has not been observed in any other specimen. Otherwise Schlechter's description and figures leave little doubt about the identity of the species.

**78. *Bulbophyllum brassii* J.J. Vermeulen, *spec. nov.* – Fig. 108.**

*Bulbophyllum brassii* *B. rhodoleuco* simile, labello angustiore differt. — Typus: Brass 10723 (AMES).

*Rhizome* creeping, 1–3 mm diam. *Pseudobulbs* globose to ovoid, 0.7–6 cm apart, 0.7–3 by 0.4–1.1 cm, not or hardly flattened. *Petiole* 4–22 mm. *Leaf blade* elliptic to obovate, 3.5–17 by 0.7–1.9 cm, index 2.7–28, tip acute. *Inflorescence* 3–9 cm, 1-flowered. *Peduncle* 0.5–4.5 cm; bracts 3–4, the longest 4–8 mm. *Floral bracts* tubular, 4.5–8 mm, tip acuminate. *Pedicel and ovary* 7–22 mm, with the node 1–3.5 mm from the floral bract. *Flowers* moderately opening. *Median sepal* ovate, 16–50 by 3–11 mm, index 3.7–6, tip long acuminate to caudate; thin; glabrous. *Lateral sepals* free, oblique, 16–50 by 3.5–10 mm, index 4.2–6, lower margin often finely papillose; otherwise as the median sepal. *Petals* oblique, ovate to triangular, 0.5–1.5 by 0.5–1.5 mm, index 0.6–1.8, tip obtuse to acuminate; thin; glabrous. *Lip* curved at the base, general outline ovate to subtriangular, 4.9–10 by 1.8–3 mm, index 2–3.3 (not spread), tip (sub) acute; approx. glabrous; thick; adx. with an inconspicuous basal concavity, basal teeth converging, not touching at the tip, together forming a transverse ridge, basal part of the lip concave, gradually passing into the somewhat convex top part of the lip; abx. with an inconspicuous, retuse median ridge. *Column* from ovary to the tip of the rostellum 1.4–2.8 mm; rostellum distinctly protruding; stigma orbicular, slightly protruding at its base; column-foot with a distinct, straight, rounded central knob above the attachment of the lip. *Anther* abx. with a ridge towards its tip; front margin protruding.

Colours – Sepals white, often with purple veins, or entirely purple. Lip golden yellow, brownish, or purple. Column white.

Ecology – Epiphyte in primary forest. Alt. 2700–3100 m asl. Flowering observed in 3, 4, 7–12.

Distribution – INDONESIA & PAPUA NEW GUINEA. New Guinea (central mountain range from Sudirman Mts to Owen Stanley Ra.).

Notes – 1. *Bulbophyllum rhodoleucum* has longer pseudobulbs, compared to the adjoining portions of the rhizome, as well as a wider lip. The differences from *B. bliteum* are given under the latter species.

2. Variability occurs in the vegetative parts: extremely slender plants occur, next to very compact ones. The flowers show variability in size, but much less in shape.

3. The species is named in honour of L.J. Brass, who made the most extensive collection of orchid specimens in Irian Jaya so far.

**79. *Bulbophyllum calviverter* J.J. Vermeulen, *spec. nov.* – Fig. 109.**

*Bulbophyllum calviverter* a *B. brachypetalum* absentia ad labelli basi duabus marginibus tenuibus erectis, a *B. minutipetalum* labello angustiore differt. — Typus: Sands et al. 1618 (K).

*Rhizome* creeping when young (but flowering already), later patent or pendulous, up to 40 cm long, 1.5–2.5 mm diam. *Pseudobulbs* approx. cylindrical, 0.3–0.7 cm apart, 1.2–3 by 0.3–0.4 cm, not flattened. *Petiole* 4–7 mm. *Leaf blade* elliptic to ovate, 3.8–7 by 0.5–1.3 cm, index 4.6–12, tip acute. *Inflorescence* 7–17 cm, 1-flowered. *Peduncle* 5–14 cm; bracts c. 4, the longest 3–5 mm. *Floral bracts* tubular, 2.5–5 mm, tip acuminate. *Pedicel and ovary* 8–15 mm, with the node 2–4 mm from the floral bract. *Flowers* moderately opening. *Median sepal* ovate, 14–40 by 3–5 mm, index 4.6–10.5, tip long acuminate to caudate; margins finely papillose; thin; surface glabrous. *Lateral sepals* free, oblique, 15–38 by 3.5–4 mm, index 5.8–9.5; margins approx. glabrous; otherwise as the median sepal. *Petals* triangular, deltoid or hastate, 1–2 by 1–1.2 mm, index 1–1.6, tip acute; margins glabrous to erose; thin; surface glabrous. *Lip* (slightly) curved at the base, sometimes slightly incurved at the tip, general outline ovate to triangular, 5.8–7 by 2.3–2.5 mm, index 1.9–2.8 (not spread), tip obtuse to acute; margins glabrous; thick; adx. with a distinct basal concavity, basal teeth converging, together forming a transverse ridge with a deep notch half-way, basal part of the lip protruding distinctly beyond the ligament, distinctly concave (margins approx. spreading and somewhat curved upwards, fleshy), gradually passing into the convex top part of the lip, surface glabrous, but often slightly papillose towards the base; abx. with an inconspicuous, truncate median ridge, surface distinctly papillose-pubescent. *Column* from ovary to the tip of the rostellum c. 1.8 mm; rostellum distinctly protruding; stigma slit-like, not protruding at its base; column-foot with a distinct but very low, distinctly upwards pointing, rounded central knob above the attachment of the lip. *Anther* abx. with a wide ridge; front margin hardly protruding.

Colours – Median sepal white or cream-coloured, purple towards the tip, and locally suffused with purple, or with purple veins. Lateral sepals white, cream-coloured or pinkish at the base, purple elsewhere. Petals white or pale purple with a cream-coloured tip. Lip yellow, suffused with purple, or entirely purple. Column cream-coloured.

Ecology – Epiphyte in primary forest. Alt. 1800–3200 m asl. Flowering observed in 1, 5, 7, 9.

Distribution – PAPUA NEW GUINEA. New Guinea (central mountain range from Western Highlands Prov. to Milne Bay Prov. Also Saruwaged Mts).

Notes – 1. Differs from *Bulbophyllum minutipetalum* in the much lower knob on the column-foot. Besides, it generally has narrower leaves, as well as a longer lip. The differences from *B. brachypetalum* are given under the latter species.

2. The lip shows a distinct variability in general aspect. This is because in some specimens the lip is curved close to its base, whereas in others it is hardly so. Although the lip has a similar structure in all specimens, the general outline is highly influenced by this difference. The width of the lip is also variable; specimens with a much wider lip than the type specimen occur. The specimens with a wide lip approach *B. minutipetalum* in this aspect, but can be distinguished from that species by the above mentioned features.

3. The name has been derived from the Latin 'calvus', bald, and 'venter', belly, referring to the approx. glabrous adaxial surface of the lip.

## 80. *Bulbophyllum cycloglossum* Schltr. – Fig. 110.

*Bulbophyllum cycloglossum* Schltr., Fedde, Rep. Beih. 1 (1913) 885; 21 (1928) f. 1190. — Type: Schlechter 18735 (holo B, †; iso AMES, L).

*Rhizome* creeping, 0.8–1.2 mm diam. *Pseudobulbs* ovoid, 0.15–0.5 cm apart, 0.3–0.7 by 0.2–0.4 cm, not or hardly flattened. *Petiole* 0.5–7 mm. *Leaf blade* elliptic to obovate, 0.4–2.5 by 0.1–0.3 cm, index 2–10, tip obtuse to acute. *Inflorescence* 0.9–2.6 cm, 1-flowered. *Peduncle* 0.3–2 cm; bracts c. 2, the longest 1.5–2 mm. *Floral bracts* tubular, 1.3–1.8 mm, tip obtuse. *Pedicel and ovary* 4–7.5 mm, with the node 0.8–2 mm from the floral bract. *Flowers* moderately opening. *Median sepal* ovate, 3.6–6 by 2–2.8 mm, index 1.6–3, tip acute to shortly acuminate; margins glabrous or slightly papillose towards the tip; thin; surface glabrous (see note). *Lateral sepals* free or partly connate along their lower margin, oblique, ovate to elliptic, 4–7.2 by 1.9–2.2 mm, index 2.1–4; otherwise as the median sepal. *Petals* absent, or, if present, elliptic, c. 0.1 by 0.3 mm, index 0.3, tip rounded; thin; glabrous. *Lip* slightly curved, general outline ovate to elliptic, 0.7–1 by 0.6–0.9 mm, index 1–1.3 (not spread), tip broadly rounded; rather thin; glabrous; adx. approx. without a basal concavity, approx. without basal teeth, concave because of the upwards curved margins, with a shallow, open slit close to the tip; abx. without a median ridge. *Column* from ovary to the tip of the rostellum 1–1.4 mm; rostellum distinctly protruding; stigma elliptic, protruding at its base; column-foot with a small, approx. straight, obtuse central knob above the attachment of the lip. *Anther* abx. with a wide ridge; front margin not protruding.

Colours – Sepals translucent white, with purple veins, or sepals entirely (dark) purple. Lip purple. Column white.

Ecology – Epiphyte in primary forest, or in shrub vegetation. Also found as a terrestrial in moss cushions in alpine grassland. Alt. 2500–3400 m asl. Flowering observed in 9–11.

Distribution – INDONESIA & PAPUA NEW GUINEA. New Guinea (central mountain range: Sudirman Mts; Western Highlands Prov.; Chimbu Prov.).

Notes – 1. The differences from *Bulbophyllum scutiferum* are given under the latter species.

2. According to Schlechter's description and plate of *Bulbophyllum cycloglossum* the sepals are papillose adaxially. However, isotype specimens in AMES and L all have entirely glabrous sepals.

3. The column and the column-foot are sometimes more elongated than in the illustrated specimen.

## 81. *Bulbophyllum discolor* Schltr.

Literature: see under the subspecies.

*Rhizome* creeping, sometimes partly patent, 1–1.8 mm diam. *Pseudobulbs* ovoid, sometimes globose, 0.1–0.7 cm apart, 0.3–1.1 by 0.2–0.8 cm, not or hardly flattened. *Petiole* 0.3–4 mm. *Leaf blade* elliptic to obovate, 0.5–3.5 by 0.2–0.7 cm, index 1.3–11, tip obtuse to acute. *Inflorescence* 2.2–7 cm, 1-flowered. *Peduncle* 1.8–6.5 cm; bracts 2–3, the longest 1.5–5 mm. *Floral bracts* tubular, 1–5 mm, tip acuminate. *Pedicel and ovary* 3.5–9 mm, with the node 0.5–2 mm from the floral bract. *Flowers* widely opening. *Median sepal* ovate to elliptic, 3–20 by 1.2–3 mm, index 2–6.7, tip acute to caudate; margins glabrous to finely papillose or ciliate; thin; adx. glabrous to finely papillose; abx. glabrous. *Lateral sepals* free, oblique, 3–16 by 1.5–5 mm, index 1.5–3.5; otherwise as the median sepal. *Petals* oblique, (ob)ovate to elliptic to (inverted) triangular, 0.7–2.2 by 0.5–2 mm, index 0.4–2, tip truncate to obtuse; margins glabrous, erose or partly denticulate;

thin; surface glabrous. *Lip* approx. straight or curved, general outline ovate to elliptic or approx. orbicular, 1–3 by 0.7–2.2 mm, index 0.8–1.5 (not spread), tip rounded to obtuse; margins finely papillose to ciliate; thick; surface finely papillose; adx. with a distinct basal concavity, basal teeth converging, together forming a transverse ridge with a notch half-way, basal part of the lip approx. flat to distinctly convex, gradually passing into the approx. flat or slightly convex top part of the lip; abx. with an inconspicuous, truncate median ridge. *Column* from ovary to the tip of the rostellum 0.8–2 mm; rostellum distinctly protruding; stigma orbicular, protruding at its base or not; column-foot with a distinct, straight to distinctly upwards pointing, rounded central knob above the attachment of the lip. *Anther* abx. with a ridge towards its tip; front margin not protruding.

Notes – 1. The differences from *Bulbophyllum intersitum*, *B. minutipetalum*, *B. octarhenipetalum*, *B. plicatum* and *B. santoense* are given under those species.

2. *Bulbophyllum discolor* shows extensive variability in the size and the shape of the vegetative parts, in the sepals (acute to caudate), the shape of the petals, and the structure of the lip. With the material available at present, two subspecies can be distinguished on account of the shape of the lip, combined with the size of the flower parts. However, more material of subsp. *cubitale* may show either that two distinct species should be recognized, or that the two subspecies should be synonymized because intermediates exist. Now, only a single specimen (Gyldenstolpe s.n., 10/1951; here included in subsp. *discolor*; measurements between brackets) is somewhat intermediate between the two: in the size of the flowers it approaches subsp. *cubitale*, whereas the shape of the lip is more similar to subsp. *discolor*. The specimen originates from an area where both subspecies occur.

#### KEY TO THE SUBSPECIES

- 1a. Lip (widely) ovate to elliptic in outline. Median sepal (4–)6–16 mm long  
a. subsp. **discolor**  
 b. Lip approx. orbicular in outline. Median sepal 3–4.3 mm long . **b. subsp. *cubitale***

**a. subsp. *discolor*** – Fig. 111a–n; Plate 5c.

*Bulbophyllum discolor* Schltr., Fedde, Rep. Beih. 1 (1913) 790; 21 (1928) f. 1015. — Type: Schlechter 20248 (B, †). Neotype: Jongejan 747 (L).

*Sepals* acuminate to caudate, the median (4–)6–20 mm long. *Petals* 0.8–2.2 mm long. *Lip* (1–)1.3–3 mm long, ovate to elliptic in outline.

Colours – Sepals white, greenish yellow or pinkish purple, often with purple veins and/or tip, or sepals entirely (dark) purple. Petals white or yellowish, vein and/or margins purple, or entirely purple. Lip cream-coloured to orange, often with purple veins, or entirely purple.

Ecology – Epiphyte in primary forest. Alt. 2000–3000 m asl. Flowering 1–7, 9–12.

Distribution – INDONESIA & PAPUA NEW GUINEA. New Guinea (central mountain range from Sudirman Mts to Milne Bay Prov. Also Saruwaged Mts; Huon Peninsula).

**b. subsp. *cubitale*** J.J. Vermeulen, *subsp. nov.* – Fig. 111o–q.

*Bulbophyllum discolor* subsp. *cubitale* a subsp. typica sepalis brevioribus labello rotundo distinguendum. — Typus: Jongejan 3230 (L).

*Sepals* acute to very shortly acuminate, the median 3–4.3 mm long. *Petals* 0.7–0.9 mm long. *Lip* 1–1.3 mm long, approx. orbicular in outline.

Colours – Sepals whitish with dark purple veins. Petals white with a purple vein. Lip purple.

Ecology – Epiphyte in primary forest. Also found in an isolated tree. Alt. 2100–2500 m asl. Flowering observed in 9.

Distribution – PAPUA NEW GUINEA. New Guinea (central mountain range: Eastern Highlands Prov.; Wharton Ra.).

Note – The name has been derived from the Latin ‘cubital’, cushion, and refers to the shape of the lip.

## 82. *Bulbophyllum hiljeae* J.J. Vermeulen – Fig. 112.

*Bulbophyllum hiljeae* J.J. Vermeulen, *Orchideeën* 54 (1992) 201. — Type: Jongejan 1097 (L).

*Rhizome* creeping, 1.5–2 mm diam. *Pseudobulbs* ovoid, 0.5–0.7 cm apart, 1.4–3 by 0.5–0.7 cm, hardly flattened. *Petiole* 7–14 mm. *Leaf blade* elliptic, 6.3–7 by 1.9–2.3 cm, index 2.7–3.7, tip acuminate. *Inflorescence* pendulous, 35–47 cm, 1-flowered. *Peduncle* 22–35 cm; bracts c. 5, the longest 7–8 mm. *Floral bracts* tubular, 6–7 mm, tip acuminate. *Pedicel and ovary* 30–45 mm, with the node 4.5–6 mm from the floral bract. *Flowers* moderately opening. *Median sepal* ovate, 65–70 by 7–8 mm, index 8.8–9.3, tip caudate; thin; glabrous. *Lateral sepals* free, 70–85 by 8–9.5 mm, index 8.7–9; otherwise as the median sepal. *Petals* oblique, ovate, 1.2–1.5 by 1–1.2 mm, index 1.2–1.3, tip acute; thin; glabrous. *Lip* slightly curved, general outline ovate, c. 15 by 2.5–2.7 mm, index 5–5.6 (not spread), tip approx. acute; margins approx. glabrous; thick; adx. with a distinct basal concavity, basal teeth somewhat converging, not touching at the tip, basal part of the lip slightly concave, with an inconspicuous median ridge, surface glabrous, gradually passing into the top part of the lip, top part of the lip with a distinct, rounded median crest, surface somewhat transversely wrinkled; abx. approx. without a median ridge, surface slightly papillose towards the base, transversely wrinkled towards the tip. *Column* from ovary to the tip of the rostellum c. 3 mm; rostellum distinctly protruding; stigma elliptic, not protruding at its base; column-foot with a distinct, approx. straight, rounded central knob above to the attachment of the lip. *Anther* abx. with a ridge towards its tip; front margin somewhat protruding.

Colours – Sepals white with thin, pinkish purple veins. Lip white, slightly cream-coloured adaxially towards its base. Column pale yellow.

Ecology – Epiphyte in primary forest, near the forest floor. Alt. c. 2000 m asl. Flowering (?) (all from two records).

Distribution – PAPUA NEW GUINEA. New Guinea (Milne Bay Prov.).

Note – The differences from *Bulbophyllum lophoton* are given under that species.

## 83. *Bulbophyllum inciferum* J.J. Vermeulen, *spec. nov.* – Fig. 113.

*Bulbophyllum inciferum* in sect. *Peltopode* labelli basi adaxialiter incrassitudine circa inciformi argute delimitata insigniter proprium. — Typus: Carr 10588 (holo L, iso BM, CANB, K, LAE).

*Rhizome* creeping, 0.8–1 mm diam. *Pseudobulbs* ovoid, 0.2–0.4 cm apart, 0.3–0.9 by 0.15–0.25 cm, not or hardly flattened. *Petiole* 6–15 mm. *Leaf blade* elliptic, 2.7–9



by 0.15–0.3 cm, index 18–50, tip acute. *Inflorescence* 5–15 cm, 1-flowered. *Peduncle* 3.5–11 cm; bracts c. 2, the longest 2.8–3.5 mm. *Floral bracts* tubular, 3–4 mm, tip acuminate. *Pedicel and ovary* 6–16 mm, with the node 1.5–1.8 mm from the floral bract. *Flowers* moderately opening. *Median sepal* ovate, 10–22 by 3–4 mm, index 3–5.5, tip long acuminate to caudate; thin; glabrous. *Lateral sepals* free, oblique, 15–26 by 3.5–4.5 mm, index 3.7–7.4; otherwise as the median sepal. *Petals* obovate, c. 0.9 by 0.7 mm, index c. 1.3, tip obtuse; thin; glabrous. *Lip* approx. straight (?), general outline ovate, 4.8–7 by 2–3 mm, index 2.2–2.6 (not spread), tip approx. acute to shortly acuminate; rather thin; glabrous; adx. with a distinct basal concavity, basal teeth converging, together forming a transverse ridge, fused to a high, sharply outlined, approx. box-shaped callus, top part of the lip approx. flat; abx. without a median ridge. *Column* from ovary to the tip of the rostellum 1.8–2 mm; rostellum distinctly protruding; stigma slit-like, not protruding at its base; column-foot with a small, slightly upwards pointing, obtuse central knob above the attachment of the lip. *Anther* abx. with a ridge towards its tip; front margin not protruding.

Colours – Sepals ochre, suffused with purple towards the tip. Petals white. Lip ochre, often suffused with purple; callus purple, with a white crest. Column white.

Ecology – Epiphyte in forest. Alt. c. 2000 m asl. Flowering observed in 12.

Distribution – PAPUA NEW GUINEA. New Guinea (central mountain range: Owen Stanley Ra.).

Note – Characterized by the approx. box- or anvil-shaped callus on the adaxial side of the lip, at its base (hence the name: the Latin ‘incus’, meaning anvil).

#### 84. *Bulbophyllum intersitum* J.J. Vermeulen, *spec. nov.* – Fig. 114; Plate 5d.

*Bulbophyllum intersitum* *B. discolori* simillimum, a labelli indice differt: *B. discolor* usque ad 1.5, *B. intersitum* plus quam 1.8. — Typus: Jongejan 795 (L).

*Rhizome* creeping, 0.8–1.2 mm diam. *Pseudobulbs* ovoid, 0.2–0.7 cm apart, 0.3–0.9 by 0.2–0.4 cm, not or hardly flattened. *Petiole* 1–10 mm. *Leaf blade* elliptic to obovate, 0.6–4 by 0.2–0.7 cm, index 2.4–14, tip acute. *Inflorescence* 4.5–8 cm, 1-flowered. *Peduncle* 3.5–6.5 cm; bracts c. 2, the longest 1.8–3 mm. *Floral bracts* tubular, 1.5–3 mm, tip acute to acuminate. *Pedicel and ovary* 3.5–12 mm, with the node 1–2.5 mm from the floral bract. *Flowers* moderately opening. *Median sepal* ovate, 6–24 by 1.5–2.8 mm, index 3.5–8.6, tip long acuminate to caudate; margins glabrous to finely ciliate; thin; surface glabrous. *Lateral sepals* free (sometimes somewhat adherent along their lower margins), oblique, 8–29 by 1.5–4 mm, index 2.3–8.3; otherwise as the median sepal. *Petals* ovate to elliptic, 0.6–1.5 by 0.8–1.5 mm, index 0.4–1.3, tip rounded to acute; margins glabrous to erose; thin; surface glabrous. *Lip* somewhat curved at the base, general outline ovate to triangular, often somewhat tapering towards the tip, 2.5–4.5 by 1–2.3 mm, index 1.8–2.9 (not spread), tip acute; margins finely papillose to ciliate; rather thick; surface glabrous or finely papillose locally; adx. with a distinct basal concavity, basal teeth converging, together forming a transverse ridge with a deep notch half-way, top part of the lip flat or convex; abx. with an inconspicuous, truncate median ridge. *Column* from ovary to the tip of the rostellum 1–1.8 mm; rostellum distinctly protruding; stigma obovate, slightly protruding at its base or not; column-foot with a distinct, distinctly upwards pointing, rounded central knob above the attachment of the lip. *Anther* abx. with a wide ridge towards its tip; front margin not protruding.

Colours – Sepals and petals white to pale green, with dull red to purple veins and margins. Lip suffused with dull red or purple.

Ecology – Epiphyte in primary forest. Alt. 1000–3300 m asl. Flowering observed in 2, 5, 8, 9, 12.

Distribution – PAPUA NEW GUINEA. New Guinea (central mountain range from East Sepik Prov. to Wharton Ra.).

Notes – 1. Similar to *Bulbophyllum discolor*. Diagnostic is the index of the lip: 1.5 or less in *B. discolor*, 1.8 or more in *B. intersitum*. The differences from *B. minutipetalum* and *B. octarrhenipetalum* are given under those species.

2. In some specimens the lateral sepals tend to be adherent along their lower margin. Most specimens have a lip with ciliate margins, in a few, however, the margins are finely papillose only.

3. The name refers to the fact that the species is morphologically somewhat intermediate between *Bulbophyllum discolor* and *B. octarrhenipetalum*: 'intersitus', meaning interposed.

### 85. *Bulbophyllum kenae* J.J. Vermeulen, *spec. nov.* – Fig. 115.

*Bulbophyllum kenae* in sect. *Peltopode* a labello adaxialiter fere omnino laeve abaxialiter pilis longis tecto insigniter proprium. — Typus: Cruttwell 3060 (leg. Kena) (L).

*Rhizome* creeping, c. 1 mm diam. *Pseudobulbs* ovoid, 0.2–0.5 cm apart, 0.4–1.2 by 0.2–0.3 cm, not or hardly flattened. *Petiole* 3–6 mm. *Leaf blade* elliptic, 2.5–6 by 0.2–0.3 cm, index 8–20, tip acute. *Inflorescence* 3–3.8 cm, 1-flowered. *Peduncle* c. 2 cm; bracts c. 2, the longest c. 2 mm. *Floral bracts* tubular, c. 2 mm, tip acuminate. *Pedicel and ovary* 7–9 mm, with the node 1.8–2 mm from the floral bract. *Flowers* moderately opening. *Median sepal* ovate, 12–12.5 by 2.5–3.5 mm, index 3.5–4.8, tip long acuminate; thin; glabrous. *Lateral sepals* free, 12–15 by 2.5–3.5 mm, index 4.3–4.8; otherwise as the median sepal. *Petals* triangular, 0.4–1.3 by 0.4–1 mm, index 1–1.3, tip obtuse; thin; glabrous. *Lip* curved, general outline ovate, 3.4–3.5 by 1 mm, index 3.4–3.5 (not spread), tip obtuse; margins long ciliate; thick; adx. with an inconspicuous basal concavity, approx. without basal teeth, top part of the lip with two rather inconspicuous, approx. parallel ridges, in between these ridges slightly more concave towards the tip, surface approx. glabrous except for a few long hairs close to the tip; abx. with an inconspicuous, truncate median ridge, surface with long hairs towards the margins. *Column* from ovary to the tip of the rostellum c. 1.3 mm; rostellum distinctly protruding; stigma elliptic, slightly protruding at its base; column-foot with an approx. straight, obtuse central knob above the attachment of the lip. *Anther* abx. without a ridge; front margin not protruding.

Colours – Sepals white at their base, often with purple spots, and (brownish) purple towards the tip. Lip purple.

Ecology – Epiphyte in primary forest. Alt. 2800–3100 m asl. Flowering observed in 1, 2.

Distribution – PAPUA NEW GUINEA. New Guinea (central mountain range: Western Highland Prov.; Eastern Highland Prov.).

Notes – 1. Characterized within sect. *Peltopus* by the lip, which is glabrous (except for the tip) adaxially, but densely hairy abaxially. This feature occurs in many species of sect. *Fruticicola* which, however, have a column of different shape.

2. The species has been named after the collector of the type specimen, Mr. Isaac Kena.

**86. *Bulbophyllum lophoton* J.J. Vermeulen, *spec. nov.* – Fig. 116.**

*Bulbophyllum lophoton* in sect. *Peltopode* a labello longe acuminato distaliter verrucoso latere adaxiali carina acuta insigniter proprium. — Typus: Jongejan 1369 (L).

*Rhizome* creeping, c. 2 mm diam. *Pseudobulbs* ovoid to lenticular, 1–3.5 cm apart, 0.7–1.7 by 0.9–1.2 cm, not or hardly flattened. *Petiole* 3–5 mm. *Leaf blade* elliptic to ovate, 3–5 by 1.7–2.2 cm, index 1.8–2.3, tip approx. acute. *Inflorescence* 4–9 cm, 1-flowered. *Peduncle* 1.3–5.5 cm; bracts c. 3, the longest 2.5–4 mm. *Floral bracts* tubular, c. 3.5 mm, tip acute. *Pedicel and ovary* 10–15 mm, with the node c. 2 mm from the floral bract. *Flowers* moderately opening. *Median sepal* ovate, 18–23 by 3.6–4 mm, index 4.5–6.2, tip long acuminate; rather thin; glabrous. *Lateral sepals* free, oblique, 2–2.4 by 4.3–5 mm, index 4–5.6; otherwise as the median sepal. *Petals* oblique, ovate to orbicular, 1–2.1 by 1 mm, index 1–2.1, tip obtuse; thin; glabrous. *Lip* curved at the base, general outline ovate, 8.5–10.5 by 2–2.8 mm, index 3.7–4.7 (not spread), tip long acuminate; margins erose; thick; adx. with a distinct basal concavity, basal teeth converging, not touching at the tip, basal part of the lip slightly concave, with two short, rounded, converging ridges, gradually passing into the top part of the lip, top part with a distinct, approx. sharp, erose median crest, surface glabrous but coarsely verrucose towards the tip; abx. approx. without a median ridge, surface somewhat wrinkled. *Column* from ovary to the tip of the rostellum c. 2 mm; rostellum distinctly protruding; stigma elliptic, not protruding at its base; column-foot with a distinct, upwards pointing, rounded acute central knob above the attachment of the lip. *Anther* abx. with a wide ridge; front margin not protruding.

Colours – Sepals and petals yellowish green, with or without purple veins. Lip yellow.

Ecology – Epiphyte in primary forest. Alt. 2200–2300 m asl. Flowering observed in 12.

Distribution – PAPUA NEW GUINEA. New Guinea (central mountain range: Bismarck Ra.).

Notes – 1. Differs from *Bulbophyllum hiljeae* in having shorter sepals as well as a lip with a verrucose tip.

2. The name has been derived from the Greek 'lophotos', crested.

**87. *Bulbophyllum loroglossum* J.J. Vermeulen, *spec. nov.* – Fig. 117.**

*Bulbophyllum loroglossum* in sect. *Peltopode* labello elongato plus minusve balteiformi insigniter proprium. — Typus: Jongejan 695 (leg. Schuiteman) (L).

*Rhizome* creeping, 1.6–2 mm diam. *Pseudobulbs* ovoid, 0.2–0.8 cm apart, 0.7–2 by 0.7–0.8 cm, hardly flattened. *Petiole* 8–18 mm. *Leaf blade* elliptic, 3–4.8 by 0.9–1.3 cm, index 2.8–4.2, tip obtuse. *Inflorescence* 11–15 cm, 1-flowered. *Peduncle* 5.5–8.5 cm; bracts c. 3, the longest c. 6 mm. *Floral bracts* tubular, 4–4.5 mm, tip acuminate. *Pedicel and ovary* 40–56 mm, with the node 4–5 mm from the floral bract. *Flowers* moderately opening. *Median sepal* ovate, 28–34 by 5–6 mm, index 4.6–6.8, tip sharply acute; margins finely papillose-erose; thin; surface glabrous. *Lateral sepals* free, 28–29 by 6–6.5 mm, index 4.3–4.8; otherwise as the median sepal. *Petals* oblique, ovate to orbicular, 4–5 by 4–4.5 mm, index 1–1.2, tip rounded to obtuse; margins erose or papillose; very thin; surface glabrous. *Lip* approx. straight, general outline approx. strap-shaped with a wider base, 16–21 by 3–4 mm, index 5.2–5.3 (not spread), tip obtuse to acute; margins finely irregularly ciliate, rather thin; surface approx. glabrous; adx. with a rather distinct basal concavity, basal teeth converging, together forming a transverse ridge, part of the lip con-

cave, gradually passing into the flat top part of the lip; abx. approx. without a median ridge. *Column* from ovary to the tip of the rostellum c. 2.2 mm; rostellum distinctly protruding; stigma approx. orbicular, protruding at its base; column-foot with a distinct, approx. straight, rounded central knob above the attachment of the lip. *Anther* abx. with a ridge; front margin somewhat protruding.

Colours – Sepals greenish or light yellow, with or without small purple dots. Lip cream-coloured to bright yellow.

Ecology – Epiphytic or as a semi-terrestrial, growing among moss, in deep shade. Alt. 3000–3100 m asl. Flowering observed in 8.

Distribution – PAPUA NEW GUINEA. New Guinea (central mountain range: Western Highland Prov.).

Note – Characterized by the long, strap-shaped lip (Greek: 'loron', strap and 'glossa', lip).

### 88. *Bulbophyllum minutipetalum* Schltr. – Fig. 118; Plate 6a.

*Bulbophyllum minutipetalum* Schltr., Fedde, Rep. Beih. 1 (1913) 761; 21 (1928) f. 962. — Type: Schlechter 18536 (B, †). Neotype: Jongejan 1739 (L).

? *Bulbophyllum blepharadenium* Schltr., Fedde, Rep. Beih. 16 (1919) 121. — Type: Kempter s.n. (B, †).

? *Bulbophyllum squamipetalum* Schltr., Fedde, Rep. Beih. 16 (1919) 126. — Type: Kempter s.n. (B, †).

*Rhizome* creeping, 2–3 mm diam. *Pseudobulbs* approx. cylindrical, 0.4–2 cm apart, 1.5–5.5 by 0.3–0.5 cm, not or hardly flattened. *Petiole* 7–28 mm. *Leaf blade* elliptic to obovate, 2.8–17 by 0.7–3 cm, index 3–10, tip acute to acuminate. *Inflorescence* 8–11 cm, 1-flowered. *Peduncle* 2.5–5 cm; bracts c. 2, the longest 4–7 mm. *Floral bracts* tubular, 5–6 mm, tip acuminate. *Pedicel and ovary* 14–30 mm, with the node 2.2–3.5 mm from the floral bract. *Flowers* moderately opening. *Median sepal* ovate, 25–48 by 3.5–9 mm, index 4–10.5, tip caudate; margins finely papillose to ciliate; thin; adx. glabrous or pubescent; abx. glabrous. *Lateral sepals* free, oblique, 25–48 by 4–8 mm, index 4–9, upper margin often approx. glabrous; otherwise as the median sepal. *Petals* oblique, ovate, 0.5–1 by 0.6–1.4 mm, index 0.4–1.7, tip obtuse to acute; margins glabrous or erose; thin; surface glabrous. *Lip* curved, general outline approx. ovate, 4–6 by 2.8–4 mm, index 0.9–2 (not spread), tip obtuse to acuminate; margins finely papillose or ciliate; rather thick; adx. with a distinct basal concavity, basal teeth converging, together forming a transverse ridge with a slit or a notch half-way, basal part of the lip slightly concave because of the somewhat upwards folded margins, either gradually, or with a fold passing into the flat or somewhat convex top part of the lip, surface papillose around the basal teeth and towards the margins, otherwise approx. glabrous; abx. with an inconspicuous, truncate median ridge, surface somewhat papillose. *Column* from ovary to the tip of the rostellum 1.8–2.5 mm; rostellum distinctly protruding; stigma elliptic, not protruding at its base; column-foot with a distinct, high, distinctly upwards pointing, rounded central knob above the attachment of the lip. *Anther* abx. with a wide ridge; front margin not protruding.

Colours – Sepals white or cream-coloured. Lip white, cream-coloured or greenish.

Ecology – Epiphyte in primary forest, often near the forest floor in deep shade. Possibly in secondary forest as well. Alt. 1100–2000 m asl. Flowering 3, 7–11.

Distribution – PAPUA NEW GUINEA. New Guinea (Western to Eastern Highlands Prov.; Milne Bay Prov. Also in mountain ranges N of Sepik R.).

Notes – 1. Differs from *Bulbophyllum discolor* as well as *B. intersitum* in having a lip with the margins folded upwards in such a way that the basal part of the lip is more or less concave. The same more or less holds for *B. octarrhenipetalum*; see, however, the note under the latter species. *Bulbophyllum plicatum* is distinctly smaller in all parts. The diagnostic differences from *B. brachypetalum*, *B. calviventer* and *B. santoense* are given under those species.

2. *Bulbophyllum minutipetalum* is very variable. A specimen with the sepals pubescent adaxially has been illustrated; most specimens, however, have sepals which are glabrous adaxially. The lip shows a distinct variability in general aspect. This is because in some specimens the lip is curved close to its base, whereas in others it is somewhere half-way. Although the lip has a similar structure in all specimens, the general outline is highly influenced by this difference.

3. The types of *Bulbophyllum blepharadenium* and *B. squamipetalum* are lost. The descriptions are not sufficiently clear to establish their identity beyond any doubt, but they probably belong here.

### 89. *Bulbophyllum octarrhenipetalum* J.J. Smith – Fig. 119.

*Bulbophyllum octarrhenipetalum* J.J. Smith, Fedde, Rep. 12 (1913) 400. — Type: Gjellerup 1090 (holo BO, iso L).

*Bulbophyllum quadrans* J.J. Smith, Nova Guinea 12, 4 (1916) 401. — Syntypes: Janowsky 368 (BO), 418 (BO).

*Bulbophyllum longipiliferum* J.J. Smith Bot. Jahrb. 66 (1934) 204. — Type: Mayr 539 (BO, L).

*Rhizome* creeping, 1.2–1.5 mm diam. *Pseudobulbs* ovoid, 0.2–0.6 cm apart, 1.1–2.5 by 0.3–0.5 cm, not or hardly flattened. *Petiole* 4–15 mm. *Leaf blade* elliptic to obovate, 3.3–7.5 by 0.8–1.4 cm, index 3.9–7.5, tip acute. *Inflorescence* 4–9 cm, 1-flowered. *Peduncle* 2–3 cm; bracts 2–3, the longest 3.5–5 mm. *Floral bracts* tubular, c. 3 mm, tip obtuse to acute. *Pedicel and ovary* 11–23 mm, with the node 1.7–3.5 mm from the floral bract. *Flowers* moderately opening. *Median sepal* ovate, 6–37 by 3–7 mm, index 1.2–12.3, tip short acuminate to caudate; margins glabrous to finely ciliate; thin; adx. glabrous to slightly pubescent; abx. glabrous. *Lateral sepals* free, oblique, 6–37 by 2.5–6 mm, index 1.5–15, tip acute to caudate; otherwise as the median sepal. *Petals* ovate to triangular, 0.4–1.3 by 0.9–2.5 mm, index 0.3–0.7, tip rounded to obtuse; margins glabrous to deeply lacerate; thin; surface glabrous. *Lip* approx. straight or somewhat curved, general outline approx. orbicular, ovate, elliptic, or triangular, 3.5–6.5 by 1.6–6 mm, index 1–3 (not spread), tip rounded to approx. acuminate; margins finely papillose; rather thick; surface approx. glabrous; adx. with a distinct basal concavity, basal teeth converging, together forming a transverse ridge with a notch half-way, basal part of the lip convex to slightly concave, gradually passing into the flat or convex top part of the lip; abx. with or without an inconspicuous, truncate median ridge. *Column* from ovary to the tip of the rostellum 1.5–1.8 mm; rostellum distinctly protruding; stigma orbicular, (slightly) protruding at its base; column-foot with a distinct, distinctly upwards pointing, rounded, central knob above the attachment of the lip. *Anther* abx. with a wide ridge; front margin not protruding.

*Colours* – Sepals and petals white or cream-coloured. Lip white or purple.

*Ecology* – Epiphyte in primary forest. Alt. 1600–2300 m asl. Flowering 4–8, 12.

*Distribution* – INDONESIA. New Guinea (Cendrawasih Peninsula; Yaramaniapuka Ra.).

Notes – 1. Differs from *Bulbophyllum discolor* as well as *B. intersitum* in having larger vegetative parts, which is best expressed in the length of the pseudobulbs as well as the width of the leaves. However, some overlap exists, and additional differences are needed. *Bulbophyllum discolor* always has a shorter lip, and *B. intersitum* generally (but not always) has a ciliate lip. In combination these characters sufficiently define the three species.

*Bulbophyllum minutipetalum* differs in having larger, cylindrical pseudobulbs, and in the lip which has a concave basal part. However, Janowsky 368 and 418, the syntypes of *B. quadrans* also have a lip which is slightly concave towards its base. These two specimens differ from *B. minutipetalum* in having approx. acute, not caudate, sepals.

The differences from *Bulbophyllum artostigma* and from *B. patella* are given under those species.

2. As considered here, *Bulbophyllum octarrhenipetalum* is an extremely variable species. When looking at the shape of the lip and the sepals, it seems hardly possible that the types of *B. quadrans* and *B. longipiliferum* (see Fig. 119) belong to a single species. However, the type of *B. octarrhenipetalum* is perfectly intermediate. The sample comprises numerous flowers, presumably of different plants. Some of these are closer to *B. quadrans*, whereas others approach *B. longipiliferum*. The remaining morphological gaps between the three specimens are too insignificant to keep them as separate species here.

## 90. *Bulbophyllum origami* J.J. Vermeulen, *spec. nov.* – Fig. 120.

*Bulbophyllum origami* in sect. *Peltopode* labello medio itinere argute retrorse plicato adaxialiter carina magna retrorsa insigniter proprium. — Typus: Reeve 748 (holo L; iso K).

*Rhizome* creeping, 0.8–1.2 mm diam. *Pseudobulbs* ovoid, 0.3–0.7 cm apart, 0.3–0.8 by 0.2–0.4 cm, not or hardly flattened. *Petiole* 0.8–4 mm. *Leaf blade* elliptic, 0.8–2.5 by 0.3–0.5 cm, index 2.6–6.3, tip obtuse to acute. *Inflorescence* 3–7.5 cm, 1-flowered. *Peduncle* 1.6–5.5 cm; bracts 2–3, the longest 2–3.5 mm. *Floral bracts* tubular, 1.5–2 mm, tip acute to acuminate. *Pedicel and ovary* 3.5–13 mm, with the node 0.8–2 mm from the floral bract. *Flowers* moderately opening. *Median sepal* ovate, 9.5–13 by 4.5–6 mm, index 1.7–2.9, tip short acuminate; margins approx. glabrous to finely papillose; thin; surface glabrous. *Lateral sepals* oblique, 10–14 by 5 mm, index 2–2.8, otherwise as the median sepal. *Petals* ovate, 0.5–0.8 by 0.8–1 mm, index 0.6–0.8, tip rounded to acute; thin; glabrous. *Lip* strongly curved just above the base and sharply folded approx. half-way so that the top part (almost) touches the basal part again, general outline crescent-shaped with a protrusion on the concave side, 3.5–4 by 3.5–4 mm, index 1–1.4 (not spread), tip rounded; margins finely papillose to ciliate; rather thin; surface glabrous; adx. with the basal concavity no more than a shallow impression, basal part of the lip with a distinct, backwards projecting, high, obtuse median ridge, passing with a sharp fold into the slightly convex top part of the lip; abx. approx. without a median ridge. *Column* from ovary to the tip of the rostellum 1.5–1.9 mm; rostellum distinctly protruding; stigma slit-like, slightly protruding at its base; column-foot with a small, approx. straight, obtuse central knob above the attachment of the lip. *Anther* abx. with a wide ridge; front margin hardly protruding.

*Colours* – Sepals translucent white or very pale greenish, veins and margins dark purple. Lip white or yellow, median ridge purple.

Ecology – Epiphyte in primary forest. Alt. 2000–2200 m asl. Flowering observed in 2, 10.

Distribution – INDONESIA & PAPUA NEW GUINEA. New Guinea (central mountain range: Jayawijaya Mts; Southern Highlands Prov.; Owen Stanley Ra.).

Notes – 1. Differs from *Bulbophyllum ortalis* in having a lip which is sharply folded backwards half-way, so that base and top touch.

2. The name has been given because of the intricately folded lip, reminding of Origami, the Japanese art of folding paper into all kinds of objects.

### 91. *Bulbophyllum ortalis* J.J. Vermeulen, *spec. nov.* – Fig. 121.

*Bulbophyllum ortalis* in sect. *Peltopode* labello medio itinere reflexo nec argute plicato adaxialiter carina magna basiscopica insigniter proprium. — Typus: Jongejan 1275 (L).

*Rhizome* creeping, 0.8–1.2 mm diam. *Pseudobulbs* ovoid to ellipsoid, 0.2–0.4 cm apart, 0.5–0.9 by 0.2–0.6 cm, not or hardly flattened. *Petiole* 2–5 mm. *Leaf blade* elliptic, 0.9–3.5 by 0.4–0.7 cm, index 2–5, tip acute. *Inflorescence* 7–9 cm, 1-flowered. *Peduncle* 5.5–7 cm; bracts c. 3, the longest c. 4 mm. *Floral bracts* tubular, 1.8–2 mm, tip acuminate. *Pedicel and ovary* 10–13.5 mm, with the node 1.3–1.8 mm from the floral bract. *Flowers* moderately opening. *Median sepal* ovate, 12–22 by 4.5–6 mm, index 2–4.4, tip long acuminate; margins finely papillose; thin; surface glabrous. *Lateral sepals* free, oblique, 12–24 by 5–6 mm, index 2–5; otherwise as the median sepal. *Petals* ovate, c. 0.6–1.2 by 0.8–1 mm, index c. 0.6–1.3, tip obtuse to acute; thin; glabrous. *Lip* distinctly curved, general outline subtriangular with a protrusion on the longest side, 3–3.5 by 3 mm, index 1–1.2 (not spread), tip rounded; margins locally slightly papillose or with long papillae; rather thin; adx. with the basal concavity no more than a impression, basal part of the lip with a distinct, backwards projecting, high, obtuse, glabrous median ridge, passing approx. gradually into the top part of the lip, top part of the lip convex, approx. glabrous to densely covered with elongated papillae; abx. approx. without a median ridge, surface papillose towards the tip. *Column* from ovary to the tip of the rostellum 1.3–2 mm; rostellum distinctly protruding; stigma slit-like, slightly protruding at its base; column-foot with a small, sharply upwards pointing, obtuse central knob above the attachment of the lip. *Anther* abx. with a ridge; front margin protruding.

Colours – Sepals yellow or yellowish brown, veins and margins reddish purple. Petals white. Lip yellow or yellowish brown at the base, stained with purple, top part often bright yellow.

Ecology – Epiphyte. Alt. 1700–2000 m asl. Flowering 2, 4, 10–12.

Distribution – PAPUA NEW GUINEA. New Guinea (central mountain range: Southern Highlands Prov.; Owen Stanley Ra.).

Notes – 1. The differences from *Bulbophyllum origami* are mentioned under that species.

2. Some specimens, e.g. Reeve 139, differ from the illustrated one in having an almost glabrous top part of the lip. Otherwise they are not different.

3. The name has been derived from the Latin 'ortalis', a young bird. The lip, which moves up and down very easily, is somewhat reminiscent of a young chicken picking grains.

**92. *Bulbophyllum patella* J.J. Vermeulen, *spec. nov.* – Fig. 122.**

*Bulbophyllum patella* in sect. *Peltopode* labello lato elliptico vel ovato plus minusve concavo notatus. — Typus: Jongejan 1580 (L).

*Rhizome* creeping, 1.8–3 mm diam. *Pseudobulbs* ovoid, 0.4–0.6 cm apart, 0.8–1.8 by 0.4–0.7 cm, not or hardly flattened. *Petiole* 3–25 mm. *Leaf blade* elliptic, 2.1–7 by 0.8–1.5 cm, index 2.1–7.5, tip acute. *Inflorescence* 6.5–9 cm, 1-flowered. *Peduncle* 3.5–6.8 cm; bracts 2–3, the longest 2–5 mm. *Floral bracts* tubular, 3–3.5 mm, tip acuminate. *Pedicel and ovary* 16–35 mm, with the node 2.2–3 mm from the floral bract. *Flowers* moderately opening. *Median sepal* elliptic to obovate, 10–18 by 5.5–10 mm, index 1.3–2, tip (sub)acute; thin; glabrous. *Lateral sepals* free, oblique, ovate to elliptic, 11–21 by 4.4–8 mm, index 1.6–2.7; otherwise as the median sepal. *Petals* sometimes approx. absent, if present triangular, 0.2–0.6 by 0.6–1 mm, index 0.2–1, tip rounded to acute; thin; glabrous. *Lip* curved at the base, general outline ovate to elliptic, 8–12.5 by 4.5–8.5 mm, index 1.2–1.8 (not spread), tip rounded; rather thin; glabrous; adx. with a distinct basal concavity, basal teeth converging, not touching at the tip, top part of the lip flat or concave; abx. approx. without a median ridge. *Column* from ovary to the tip of the rostellum 2–2.5 mm; rostellum distinctly protruding; stigma orbicular, distinctly protruding at its base; column-foot with a distinct, distinctly upwards pointing, rounded central knob above the attachment of the lip. *Anther* abx. with a wide ridge; front margin protruding.

Colours – Plant green. Sepals bright yellow to orange, sometimes with purple veins. Lip bright yellow, generally with a purple median line. Column-foot white.

Ecology – Epiphyte in (low and open) primary forest. Also found as a terrestrial, among grass on clay soil on a roadside. Alt. 1600–2500 m asl. Flowering observed in 1, 2, 7, 10, 11.

Distribution – PAPUA NEW GUINEA. New Guinea (central mountain range: Western and Southern Highlands Prov.).

Notes – 1. Specimens of *Bulbophyllum octarrhenipetalum* with short and wide sepals and an elliptic lip differ in having a smaller lip with a convex top part.

2. The name has been derived from the Latin ‘patella’, a small pan, referring to the shape of the lip.

**93. *Bulbophyllum peltopus* Schltr. – Fig. 123.**

*Bulbophyllum peltopus* Schltr., Fedde, Rep. Beih. 1 (1913) 761; 21 (1928) f. 961. — Type: Schlechter 19709 (holo B, †; iso BM, K).

*Bulbophyllum planilabre* Schltr., Fedde, Rep. Beih. 1 (1913) 760; 21 (1928) f. 960. — Type: Schlechter 18585 (holo B, †; iso AMES, L).

*Rhizome* creeping, 2–3 mm diam. *Pseudobulbs* ovoid, 0.4–2 cm apart, 1.4–3.4 by 0.5–1 cm, not or hardly flattened. *Petiole* 10–20 mm. *Leaf blade* elliptic to obovate, 4–11 by 1.1–2.5 cm, index 2.3–10.5, tip acute to acuminate. *Inflorescence* 16–31 cm, 1-flowered. *Peduncle* 11–21 cm; bracts 3–4, the longest 6–9 mm. *Floral bracts* tubular, 5–7 mm, tip acute to acuminate. *Pedicel and ovary* 22–42 mm, with the node 3.2–7 mm from the floral bract. *Flowers* widely opening. *Median sepal* ovate, 29–55 by 5–9 mm, index 4.1–8.7, tip caudate; thin; glabrous. *Lateral sepals* free, oblique, 31–72 by 4.5–8.5 mm, index 4.7–10; otherwise as the median sepal. *Petals* elliptic to (ob)ovate, 2.2–5 by 0.8–1.5 mm,



index 2–5, tip rounded to acute; (rather) thin; glabrous. *Lip* approx. straight, general outline ovate to elliptic, 8–14 by 4–7 mm, index 1.7–2.4 (not spread), tip widely rounded; thick; glabrous; adx. with a distinct basal concavity, basal teeth converging, together forming a transverse ridge with a deep slit half-way, basal part of the lip widely concave, gradually passing into the slightly convex top part of the lip; abx. without a median ridge. *Column* from ovary to the tip of the rostellum 2–3 mm; rostellum distinctly protruding; stigma elliptic, not or slightly protruding at its base; column-foot with a distinct, approx. straight to somewhat upwards pointing, rounded central knob above the attachment of the lip. *Anther* abx. with a weak ridge; front margin hardly protruding.

Colours – Sepals white to bright yellow, often with pink or purple veins towards the base. Petals white or yellowish, sometimes with pink margins. Lip white or yellow, suffused with pink or purple, or entirely purple. Column white. Anther purple.

Ecology – Epiphyte in primary forest. Alt. 200–3100 m asl. Flowering 1, 2, 4, 6, 11, 12.

Distribution – INDONESIA & PAPUA NEW GUINEA. New Guinea (central mountain range from Sudirman Mts to Wharton Ra.).

Notes – 1. Characterized by the shape of the lip, which is straight, elliptic or ovate and widely concave in the basal half. *Bulbophyllum alveatum* and *B. rhodoleucum* differ in having a lip with a (sub)acute tip. *Bulbophyllum ankylochele* may have a similarly rounded lip which, however, is always somewhat recurved at the base and is much less concave adaxially. Compared to all species mentioned except *B. rhodoleucum*, *B. peltopus* has distinctly longer petals.

2. Schlechter's figure of *Bulbophyllum planilabre* shows the lip in both adx. and abx. view with a slight notch in the margins, approx. half-way. The figure of the lip in lateral view does not show these notches, and it is assumed that they are caused by artificially spreading of the lip. It was not possible to check the isotype specimens of *B. planilabre* for this feature: all the lips are broken off.

#### 94. *Bulbophyllum plicatum* J.J. Vermeulen, *spec. nov.* – Fig. 124.

*Bulbophyllum plicatum* *B. discolori* quod labellum ad basin concavum distinguendum. — Typus: Reeve 1050 (L).

*Rhizome* creeping, 0.8–1 mm diam. *Pseudobulbs* ovoid, 0.2–0.5 cm apart, 0.4–0.7 by 0.2–0.3 cm, not or hardly flattened. *Petiole* 1–2 mm. *Leaf blade* elliptic, 0.8–1.4 by 0.3–0.5 cm, index 2.6–2.8, tip acute. *Inflorescence* 1.8–2.3 cm, 1-flowered. *Peduncle* 1–1.5 cm; bracts c. 3, the longest c. 1.8 mm. *Floral bracts* tubular, c. 2 mm, tip acuminate. *Pedicel and ovary* c. 5 mm, with the node c. 1 mm from the floral bract. *Flowers* moderately opening. *Median sepal* ovate to elliptic, c. 4 by 2 mm, index c. 2, tip acute; thin; glabrous. *Lateral sepals* free, oblique, ovate, c. 3.7 by 2 mm, index 1.7–1.8; otherwise as the median sepal. *Petals* elliptic, c. 0.4 by 0.9 mm, index 0.4–0.5, tip truncate; thin; glabrous. *Lip* approx. straight, general outline ovate, c. 2 by 1.7 mm, index c. 1.2 (not spread), tip shortly acuminate; margins irregularly papillose; rather thick; surface finely papillose locally; adx. with a distinct basal concavity, basal teeth converging, together forming a transverse ridge with a deep notch half-way, basal part of the lip concave because of the sharply upwards folded margins which project as two points, passing with a fold into the approx. flat top part of the lip; abx. approx. without a median ridge. *Column* from ovary to the tip of the rostellum c. 1 mm; rostellum distinctly protruding; stigma orbicular, protruding at its

base; column-foot with a distinct, distinctly upwards pointing, rounded central knob above the attachment of the lip. *Anther* abx. with an inconspicuous ridge; front margin somewhat protruding. *Pollinia* (not seen).

Colours – Sepals whitish, yellow at the tip, veins somewhat pink in young flowers. Lip whitish, veins and upturned folds pinkish red.

Ecology – Epiphyte. Alt. above c. 1800 m asl. Flowering observed in 3.

Distribution – PAPUA NEW GUINEA. New Guinea (Saruwaged Mts).

Notes – 1. *Bulbophyllum plicatum* looks most like a small form of *B. discolor*. It has been kept as a separate species because of the shape of the lip: the margins are sharply folded upwards towards the base, thus forming a projecting corner at each side of the lip. The area in between is distinctly concave. *Bulbophyllum discolor* has a lip which is flat or convex towards the base. Besides, a shortly acuminate lip, as occurs in *B. plicatum*, has not been observed in *B. discolor*.

*Bulbophyllum minutipetalum* differs in being larger in all parts. *Bulbophyllum santonse* differs in having larger pseudobulbs and leaves, as well as in having a flat or slightly convex basal part of the lip.

2. The name refers to the shape of the lip: 'plicatus' = folded.

#### 95. *Bulbophyllum ptychantyx* J.J. Vermeulen, *spec. nov.* – Fig. 125.

*Bulbophyllum ptychantyx* in sect. *Peltopode* labelli marginibus super laterem adaxialem involutis insigniter proprium. — Typus: Cruttwell 3339 (L).

*Rhizome* creeping, c. 1.5 mm diam. *Pseudobulbs* ovoid, c. 0.4 cm apart, 1.2–2 by 0.5–0.8 cm, not or hardly flattened. *Petiole* c. 7 mm. *Leaf blade* elliptic, 6.5–12.5 by 1 cm, index c. 6.5, tip acute. *Inflorescence* c. 13 cm, 1-flowered. *Peduncle* c. 7 cm; bracts 3, the longest c. 6 mm. *Floral bracts* tubular, 6–7 mm, tip acuminate. *Pedicel and ovary* 17–20 mm, with the node 4–6 mm from the floral bract. *Flowers* moderately opening. *Median sepal* ovate, 50–80 by 6–9 mm, index 6–14, tip caudate; margins finely ciliate; rather thin; surface glabrous. *Lateral sepals* free, oblique, 55–80 by 6.5–9 mm, index 7–14; otherwise as the median sepal. *Petals* rhombiform, c. 0.6 by 1.2 mm, index c. 0.5, tip acute; rather thick; glabrous. *Lip* curved at the base, general outline ovate, 9–10 by 4–5 mm, index 2–2.3 (not spread), tip obtuse to subacute; thick; adx. with a distinct basal concavity, basal teeth converging, not touching at the tip, together forming a transverse ridge, basal part of the lip concave, margins and surface glabrous, passing into the top part of the lip with a transverse ridge which in front ends in 3 short longitudinal ridges, top part of the lip with the margins sharply folded over the adaxial side and covering most of it, margins and surface distinctly papillose-pilose; abx. without a median ridge. *Column* from ovary to the tip of the rostellum 2–3 mm; rostellum distinctly protruding; stigma orbicular, protruding at its base; column-foot with a distinct, distinctly upwards pointing, rounded central knob above the attachment of the lip. *Anther* abx. with a wide ridge on which a rounded crest towards its base; front margin somewhat protruding.

Colours – Pseudobulbs pale green. Leaves medium green. Sepals cream-coloured or straw yellow, with purple veins and sometimes with a purple tip. Lip purple, adx. with or without a white median line, sometimes white abaxially.

Ecology – Epiphyte. Alt. 2500–3000 m asl. Flowering observed in 1, 4 (in greenhouse in Europe), 11.

Distribution – PAPUA NEW GUINEA. New Guinea (Saruwaged Mts, Huon Peninsula).

Notes – 1. Characterized by the lip, which has the margins folded over the adaxial surface in its top part.

2. The name refers to this diagnostic character: ‘ptychos’ = fold, and ‘antyx’ = margin.

**96. *Bulbophyllum reevei* J.J. Vermeulen – Fig. 126; Plate 6b.**

*Bulbophyllum reevei* J.J. Vermeulen, *Blumea* 36 (1992) 479. — Type: Jongejan 1276 (L).

*Rhizome* creeping, 2–3 mm diam. *Pseudobulbs* ovoid, 0.2–0.7 cm apart, 1.2–5 by 0.4–1.1 cm, hardly flattened. *Petiole* 12–27 mm. *Leaf blade* elliptic to obovate, 5.5–13 by 2–4.2 cm, index 2.2–5.5, tip obtuse to acute. *Inflorescence* 9.5–33 cm, 1-flowered. *Peduncle* 3.5–26 cm; bracts 3–5, the longest 6–15 mm. *Floral bracts* tubular, 6–13 mm, tip acuminate. *Pedicel and ovary* 8–40 mm, with the node 4–8 mm from the floral bract. *Flowers* moderately opening. *Median sepal* ovate, 50–115 by 5–12 mm, index 4.8–12.5, tip caudate; margins approx. glabrous to finely papillose; rather thin; adx. glabrous; abx. glabrous or finely hirsute. *Lateral sepals* free, oblique, 45–130 by 6–16 mm, index 5–14.5, margins glabrous; otherwise as the median sepal. *Petals* oblique, (transversely semi-) elliptic, (ob)ovate, or triangular, 0.2–1 by 1–1.2 mm, index 0.2–1, tip rounded to acute; margins glabrous to erose; rather thin; surface glabrous. *Lip* approx. straight, general outline obovate, 6.5–15 by 5–9 mm, index 1.2–2.2 (not spread; cauda excluded), tip caudate (cauda 4.5–27 mm); margins glabrous or finely papillose to shortly ciliate; thick; adx. with a distinct basal concavity, basal teeth converging, together forming a transverse ridge with a deep slit half-way, top part of the lip with a low central callus, slightly convex or approx. flat (or concave because of upturned margins), approx. glabrous; abx. generally with a obtuse median ridge towards the tip, surface partly or entirely papillose-hirsute. *Column* from ovary to the tip of the rostellum 3–3.5 mm; rostellum distinctly protruding; stigma elliptic, hardly protruding at its base; column-foot with a distinct, distinctly upwards pointing central knob above the attachment of the lip. *Anther* abx. with a wide ridge; front margin not protruding.

Colours – Sepals cream-coloured or pale greenish, usually heavily suffused with purple, in particular around the veins and margins; or sepals entirely purple, with a yellow tip. Petals white. Lip white or yellow, often suffused with purple, or with a purple median line and tip.

Ecology – Epiphyte in primary forest, often growing near the forest floor in deep shade. Alt. 2100–3100 m asl. Flowering 1–4, 7, 10–12.

Distribution – INDONESIA & PAPUA NEW GUINEA. New Guinea (central mountain range from Sudirman Mts to Owen Stanley Ra.).

Notes – 1. Characterized by the obovate lip ending in a long cauda. The differences between *Bulbophyllum reevei* and *B. systemochilum* are given under the latter species.

2. The species shows some variability: the specimen Brass 11501, the only one from Irian Jaya, differs from the other specimens in having a shorter inflorescence as well as a lip which has the margins turned upwards towards the tip.

**97. *Bulbophyllum rhodoleucum* Schltr. – Fig. 127; Plate 6c.**

*Bulbophyllum rhodoleucum* Schltr., *Fedde, Rep. Beih.* 1 (1913) 762; 21 (1928) f. 963. — Type: Schlechter 18745 (holo B, †; iso AMES, BO, L).

*Rhizome* creeping, 2.5–5 mm diam. *Pseudobulbs* ovoid, 0.7–3 cm apart, 2.2–5.5 by 0.5–1.6 cm, not or hardly flattened. *Petiole* 6–32 mm. *Leaf blade* elliptic to obovate, 6–16 by 1–4 cm, index (2–)3–8, tip acute. *Inflorescence* 4.2–9 cm, 1-flowered. *Peduncle* 1.8–5.5 cm; bracts c. 3, the longest 4.5–12 mm. *Floral bracts* tubular, 4.5–11 mm, tip acuminate. *Pedicel and ovary* 13–32 mm, with the node 2–5 mm from the floral bract. *Flowers* moderately opening. *Median sepal* ovate, 14–57 by 5–10 mm, index 3–6, tip long acuminate to caudate; margins often slightly erose; thin; surface glabrous. *Lateral sepals* free, oblique, 15–57 by 5–10 mm, index 3–6, lower margin often finely papillose; otherwise as the median sepal. *Petals* oblique, ovate to triangular, 0.5–2.2 by 0.5–1 mm, index 0.6–3.6, tip obtuse to acuminate; thin; glabrous. *Lip* almost straight or curved at the base, general outline ovate to subtriangular, 7–16 by 4–7.5 mm, index 1.7–2.5 (not spread), tip (sub) acute; margins partly or entirely finely papillose; thick; adx. with an inconspicuous basal concavity, basal teeth converging, not touching at the tip, together forming a transverse ridge, basal part of the lip concave, often slightly papillose, gradually passing into the approx. flat and often finely transversely wrinkled top part of the lip; abx. with an inconspicuous, retuse median ridge, surface glabrous or finely papillose towards the margins. *Column* from ovary to the tip of the rostellum 2–4 mm; rostellum distinctly protruding; stigma orbicular, slightly protruding at its base; column-foot with a distinct, straight, rounded central knob above the attachment of the lip. *Anther* abx. with a ridge towards its tip; front margin protruding.

Colours – Sepals white, cream-coloured, greenish yellow, or pink, often with pink or purple veins, sometimes purple at the tip, or entirely purple. Lip (pinkish or brownish) purple, sometimes orange, white or yellow towards the base.

Ecology – Epiphyte in primary forest, usually near the forest floor. Also found as a lithophyte on rock faces, or as a terrestrial among moss. Usually growing in deep shade. Alt. 1800–2800 m asl. Flowering 4, 7–12.

Distribution – INDONESIA & PAPUA NEW GUINEA. New Guinea (central mountain range from Sudirman Mts to Owen Stanley Ra.); New Britain; New Ireland.

Note – The differences from *Bulbophyllum alveatum* and *B. ankylochele* are given under the latter species. The differences from *B. brassii*, as well as *B. peltopus* are given under those respective species.

## 98. *Bulbophyllum santoense* J.J. Vermeulen, *spec. nov.* – Fig. 128.

*Bulbophyllum santoense* a *B. minutipetalo* pseudobulbis latioribus floribus minoribus differt. — Typus: Cribb & Wheatley 87 (K).

*Bulbophyllum minutipetalum* auct. non Schltr.: Lewis & Cribb, Orch. Vanuatu (1989) 127.

*Rhizome* creeping, 1.5–2 mm diam. *Pseudobulbs* ovoid, 0.4–1.2 cm apart, 0.8–1.8 by 0.4–0.7 cm, only slightly flattened. *Petiole* 4–12 mm. *Leaf blade* elliptic, 2.8–8.5 by 1–1.5 cm, index 2.8–6, tip obtuse to acute. *Inflorescence* 4–7 cm, 1-flowered. *Peduncle* 2.5–5 cm; bracts c. 2, the longest 3–4 mm. *Floral bracts* tubular, c. 3 mm, tip acuminate. *Pedicel and ovary* c. 12 mm, with the node c. 2 mm from the floral bract. *Flowers* moderately opening. *Median sepal* ovate, c. 11 by 3.5 mm, index c. 3, tip long acuminate; margins finely papillose; thin; surface glabrous. *Lateral sepals* free, oblique, c. 12 by 4 mm, index c. 3, margins approx. glabrous; otherwise as the median sepal. *Petals* oblique, semi-

circular, c. 0.7 by 1 mm, index 0.7, tip rounded; thin; glabrous. *Lip* curved, general outline approx. ovate, c. 2.3 by 2.5 mm, index c. 0.9 (not spread), tip subacute; margins finely papillose; rather thick; adx. with a distinct basal concavity, basal teeth converging, together forming a transverse ridge with a slit half-way, basal part of the lip approx. flat or slightly convex, passing with a fold into the approx. flat top part of the lip, surface slightly papillose around the basal teeth and towards the margins, otherwise approx. glabrous; abx. with an inconspicuous, truncate median ridge, surface somewhat papillose. *Column* from ovary to the tip of the rostellum 1.8 mm; rostellum distinctly protruding; stigma elliptic, not protruding at its base; column-foot with a distinct, distinctly upwards pointing, rounded central knob above the attachment of the lip. *Anther* (not seen). *Pollinia* (not seen).

Colours – Sepals and petals yellow. Lip darker yellow.

Ecology – Found as an epiphyte on a ridge top. Alt. 1500–1600 m asl. Flowering observed in 10.

Distribution – VANUATU. Espiritu Santo.

Notes – 1. *Bulbophyllum minutipetalum* has thinner pseudobulbs and larger flowers, as well as a lip with a more or less concave basal part. *Bulbophyllum discolor* and *B. intersitum* differ in having smaller pseudobulbs and narrower leaves.

2. Named after the island on which the type specimen has been collected.

### 99. *Bulbophyllum scutiferum* J.J. Vermeulen, *spec. nov.* – Fig. 129.

*Bulbophyllum scutiferum* a *B. cycloglossum* in floribus maioribus, labello cavitate basali inconspicuo et ad basin recurvato differt. — Typus: Brass 9370 (holo AMES, iso L).

*Rhizome* creeping, 0.8–1.2 mm diam. *Pseudobulbs* ovoid, 0.1–0.7 cm apart, 0.3–0.8 by 0.2–0.3 cm, not or hardly flattened. *Petiole* 1.5–4 mm. *Leaf blade* elliptic to obovate, 0.5–2.8 by 0.25–0.5 cm, index 1.3–7, tip obtuse to acute. *Inflorescence* 3.5–9 cm, 1-flowered. *Peduncle* 2–6 cm; bracts c. 3, the longest 1–3.2 mm. *Floral bracts* tubular, 1–2.5 mm, tip acute. *Pedicel and ovary* 8–17 mm, with the node 1–2.5 mm from the floral bract. *Flowers* moderately opening. *Median sepal* elliptic, 4.5–11.5 by 2.5–4.5 mm, index 1.8–3.8, tip acute; thin; glabrous. *Lateral sepals* free, ovate to elliptic, 4–13.5 by 2–4.5 mm, index 2–3.6; otherwise as the median sepal. *Petals* triangular, c. 0.3 by 0.5 mm, index c. 0.6, tip subacute; thin; glabrous. *Lip* curved at the base, general outline obovate, 1.8–3 by 1–3 mm, index 1–2 (not spread), tip broadly rounded; rather thick; glabrous; adx. with a rather inconspicuous basal concavity, basal teeth converging, together forming a transverse ridge, basal part of the lip slightly concave, passing with an inconspicuous, v-shaped transverse ridge into the top part of the lip, top part of the lip slightly convex, with a median furrow; abx. without a median ridge. *Column* from ovary to the tip of the rostellum 1.4–2.7 mm; rostellum distinctly protruding; stigma ovate, slightly protruding at its base; column-foot with a small, approx. straight, obtuse central knob above the attachment of the lip. *Anther* abx. with a ridge towards its base; front margin somewhat protruding.

Colours – Flowers yellowish, sometimes mottled with purple.

Ecology – Epiphyte in primary forest. Alt. 2300–3300 m asl. Flowering observed in 8, 10, 12.

Distribution – INDONESIA & PAPUA NEW GUINEA. New Guinea (central mountain range, locally from Sudirman Mts to Wharton Ra.).

Notes – 1. *Bulbophyllum cycloglossum* differs in having a smaller lip, which is not recurved at the base. *Bulbophyllum patella* has a larger lip (also when compared to the length of the sepals), and an upwards pointing central knob on the column-foot.

2. The name has been derived from the Latin 'scutum', a shield, referring to the shape of the lip.

#### 100. *Bulbophyllum subapetalum* J.J. Smith – Fig. 130.

*Bulbophyllum subapetalum* J.J. Smith, Meded. Herb. Leiden 23 (1915) 23. — Type: Janowsky 411 (holo BO, iso L).

*Rhizome* patent or pendulous, up to 50 cm long, 2–3 mm diam. *Pseudobulbs* approx. cylindrical, 2.5–4.5 cm apart, 1–1.6 by 0.2–0.35 cm, not flattened; new shoots arising just below the tip of the pseudobulb. *Petiole* 2–4 mm. *Leaf blade* ovate, 4.8–9 by 0.6–1.4 cm, index 4.5–9, tip acute. *Inflorescence* 2.2–3 cm, 1-flowered. *Peduncle* 0.5–1 cm; bracts 2–3, the longest 3.5–4 mm. *Floral bracts* tubular, 3–3.5 mm, tip acuminate. *Pedicel and ovary* 7–10 mm, with the node 2–2.5 mm from the floral bract. *Flowers* widely opening. *Median sepal* ovate, 8–18 by 2.3–4.5 mm, index 3.4–4.8, tip long acuminate to caudate; margins finely ciliate; thin; surface glabrous. *Lateral sepals* free, oblique, 8–18 by 2.5–4.5 mm, index 3.2–4.5; otherwise as the median sepal. *Petals* ovate, 0.3–0.4 by 0.5–0.8 mm, index 0.4–0.8, tip apiculate; thin; glabrous. *Lip* slightly curved, general outline ovate, 2–4.5 by 0.9–2.3 mm, index 1.9–2.9 (not spread), tip a thick, cylindrical, obtuse appendage of 0.8–1.5 mm long; thick; glabrous; adx. with a distinct basal concavity, basal teeth converging, together forming a transverse ridge, basal part of the lip concave, with a rather distinct, loop-shaped callus, passing with a transverse ridge (= the front edge of the loop) into the top part of the lip, top part of the lip convex but with a transverse impression in front of the loop; abx. with an inconspicuous, truncate median ridge. *Column* from ovary to the tip of the rostellum 0.8–1.5 mm; rostellum distinctly protruding; stigma slit-like, slightly protruding at its base or not; column-foot with a distinct, approx. straight, obtuse central knob above the attachment of the lip. *Anther* abx. with a ridge towards its tip; front margin protruding.

Colours – Sepals and petals yellow. Lip yellow, near the base red towards the margins; tip of the lip blue (correct?) (colours according to the collector, fide J.J. Smith).

Ecology – Epiphyte in primary forest. Alt. (?) m asl. Flowering observed in 5, 6.

Distribution – INDONESIA. New Guinea (Yaramaniapuka Ra.).

Notes – 1. Well characterized by the thick, obtuse, cylindrical appendage at the tip of the lip.

2. The long pendulous habit, as well as the new shoots arising almost from the top of the pseudobulbs, are features which do not occur elsewhere within sect. *Peltopus*, but which are widespread in sections *Fruticicola* and *Epibulbon*. However, the structure of the tip of the column, as well as of the column-foot and the lip, make the species fit in sect. *Peltopus*.

#### 101. *Bulbophyllum systemochilum* J.J. Vermeulen, *spec. nov.* – Fig. 131.

*Bulbophyllum systemochilum* in sect. *Peltopode* labello longe acuminato adaxialiter sine callo humili distaliter manifeste convexo insigniter proprium. — Typus: Brass 9110 (AMES).

*Rhizome* creeping, 1–2.5 mm diam. *Pseudobulbs* ovoid, 1–2.5 cm apart, 0.7–1.8 by 0.3–0.5 cm, hardly flattened. *Petiole* 3–6 mm. *Leaf blade* elliptic, 20–52 by 0.3–0.6 cm, index 5.5–9, tip acute. *Inflorescence* 13.5–22 cm, 1-flowered. *Peduncle* 10–16 cm; bracts 4–5, the longest 7–9 mm. *Floral bracts* tubular, 6–8 mm, tip acute. *Pedicel and ovary* 12–18 mm, with the node 3.5–4 mm from the floral bract. *Flowers* moderately opening. *Median sepal* ovate, 28–48 by 6–8 mm, index 3.5–8, tip caudate; rather thin; glabrous. *Lateral sepals* free, oblique, 32–46 by 6–9 mm, index 3.8–5.3; otherwise as the median sepal. *Petals* oblique, ovate to triangular, 0.8–1.2 by 0.8–1.2 mm, index c. 1, tip obtuse to acute; thin; glabrous. *Lip* approx. straight, general outline elliptic or slightly obovate, 15–20 by 3.4–4.5 mm, index 3.7–4.6 (not spread), tip long acuminate; thick; approx. glabrous; adx. with a distinct basal concavity, basal teeth converging, together forming a transverse ridge with a deep slit half-way, basal part of the lip with two short, rounded ridges, gradually passing into the convex top part of the lip; abx. approx. without a median ridge. *Column* from ovary to the tip of the rostellum 2–3 mm; rostellum distinctly protruding; stigma elliptic, slightly protruding at its base; column-foot with a distinct, somewhat upwards pointing, rounded central knob above the attachment of the lip. *Anther* abx. with a ridge towards its tip; front margin protruding. *Pollinia* (not seen).

Colours – Sepals pale purple with darker veins, or entirely dark purple. Lip purple, with or without a yellow tip.

Ecology – Terrestrial, found among moss in open thickets. Alt. c. 3200 m asl. Flowering 8 (all from two records).

Distribution – INDONESIA. New Guinea (Sudirman Mts).

Notes – 1. *Bulbophyllum reevei* differs in having a wider lip which is less convex in the top half, and which has a central callus adaxially. *Bulbophyllum aechmophorum* has a sub-acute lip with a less convex top part.

2. The name has been derived from the Greek ‘systemos’, tapering, and ‘cheilos’, lip.

## 102. *Bulbophyllum thelantyx* J.J. Vermeulen, *spec. nov.* – Fig. 132.

*Bulbophyllum thelantyx* in sect. *Pelopode* rhizomate patenti et labelli marginibus papillois vel ciliatis insigniter proprium. — Typus: Jongejan 706 (L).

*Rhizome* patent, up to 8 cm long, c. 1.5 mm diam. *Pseudobulbs* ovoid, 0.2–0.4 cm apart, 2–3 by 0.4–0.6 cm, not or hardly flattened. *Petiole* 3–7 mm. *Leaf blade* ovate to elliptic, 4.5–5.6 by 0.5–0.9 cm, index 5.5–12, tip acute. *Inflorescence* 4.5–7 cm, 1-flowered. *Peduncle* 3–4.3 cm; bracts c. 2, the longest 3–4.5 mm. *Floral bracts* tubular, 2.2–3.8 mm, tip approx. acute. *Pedicel and ovary* 9–13 mm, with the node 1.3–2.5 mm from the floral bract. *Flowers* moderately opening. *Median sepal* ovate, 9–17 by 5–7 mm, index 1.8–2.6, tip acute to shortly acuminate; margins finely ciliate; thin; surface glabrous. *Lateral sepals* free, oblique, 10–20 by 4–6 mm, index 2.2–3.3, margins glabrous; otherwise as the median sepal. *Petals* triangular, 0.6–1.2 by 0.4–0.8 mm, index c. 1.5, tip acute; margins erose; thin; surface glabrous. *Lip* curved, general outline ovate, 2.5–6 by 2.2–3.5 mm, index 1.1–1.7 (not spread), tip rounded; margins papillose or ciliate; rather thick; adx. with an inconspicuous basal concavity, basal teeth converging, together forming a transverse ridge, with a notch half-way, top part of the lip concave because of the distinctly upwards curved margins, median strip glabrous, papillose or ciliate towards the

margins; abx. approx. without a median ridge, surface glabrous. *Column* from ovary to the tip of the rostellum 1.4–2 mm; rostellum distinctly protruding; stigma slit-like, slightly protruding at its base; column-foot with a distinct, somewhat upwards pointing, obtuse central knob above the attachment of the lip. *Anther* abx. with an inconspicuous ridge; front margin not protruding.

Colours – Sepals yellow, sometimes with red or purple veins. Petals pale yellow. Lip yellow, sometimes with a red tip, or entirely dark red.

Ecology – Epiphyte in primary forest, near the forest floor. Alt. 1800–3000 m asl. Flowering observed in 1, 11, 12.

Distribution – PAPUA NEW GUINEA. New Guinea (central mountain range: Lake Kapiago to Bismarck Ra.).

Notes – 1. Within sect. *Peltopus* well characterized by having a patent, not a creeping rhizome, combined with the distinctly papillose or ciliate margins of the lip.

2. The name has been derived from the Greek ‘thele’, nipple, and ‘antix’, edge or rim. The name refers to the papillose or ciliate margins of the lip.

### Section *Uncifera*

*Bulbophyllum* sect. *Uncifera* Schltr., Fedde, Rep. Beih. 1 (1912) 696 & 738. — Lectotype species: *Bulbophyllum ochroleucum* Schltr.

*Bulbophyllum* sect. *Manobulbon* Schltr., Fedde, Rep. Beih. 1 (1912) 696 & 732. — Lectotype species: *Bulbophyllum cylindrobulbum* Schltr.

*Bulbophyllum* sect. *Diceras* Schltr., Fedde, Rep. Beih. 1 (1912) 696 & 739. — Lectotype species: *Bulbophyllum diceras* Schltr. (= *Bulbophyllum posticum* J.J. Smith).

*Bulbophyllum* subgen. *Harpobrachium* Schltr., Fedde, Rep. Beih. 1 (1912) 696; P. Royen, Alpine Fl. New Guinea 2 (1979) 170. — Lectotype species: *Bulbophyllum manobulbon* Schltr. (design. P. Royen).

*Rhizome* creeping (Series A), or patent to pendulous (Series B); rhizome scales shorter or longer than the internodes they cover. *Roots* sprouting along the entire rhizome; or below the older pseudobulbs only in case the rhizome is pendulous. *Inflorescence* with 1 or more flowers. *Median sepal*: tip acute to caudate. *Petals* distinct, not very small. *Lip* not divided into lobes; lip above the ligament without a concavity with two teeth in front. *Column*: rostellum not protruding in lateral view; base of the stigma not or hardly protruding in lateral view, without teeth; column-foot without accessories. *Stelidia* present but sometimes inconspicuous, with a distinct, approx. downwards directed, straight or recurved, semi-elliptic, generally rounded tooth along their lower margin, very close to the tip. *Pollinia* 2 or 4, if 4 the inner pair half as long as the outer pair or less, rarely slightly more than half as long as the outer pair (*bigibbum*). *Stipes* absent.

Notes – 1. Section *Uncifera* is characterized by the peculiar, often hooked tooth along the lower margin of the stelidia, close to their tip. Although at first sight this tooth may be confused with the various ornaments occurring along the lower margin of the stelidia in other sections, it is very characteristic at closer scrutiny. To get familiar with this character one is advised to compare the plates of the various species of this section.

2. Comparatively this section is poorly resolved into species. Only *Bulbophyllum cavibulbum*, *B. exiguum* and *B. posticum* are characterized by unique features. The others are



mainly characterized by combinations of states of a small number of characters: rhizome creeping or hanging, inflorescence with 1 or with 2 to many flowers; pollinia 2 or 4. The demarcations between the species thus characterized are further obscured by the extreme variability of *B. cylindrobulbum* and *B. ochroleucum*.

KEY TO THE SPECIES OF SECTION UNCIFERA

- 1a. Length of the median sepal 1.5 times the length of the lip or shorter (remove both parts from the flower for comparison, and do not stretch the lip artificially!)
  - 104. *B. exiguum***
- b. Length of the median sepal 1.8 times the length of the lip or longer . . . . . 2
- 2a. Lip adaxially near the base with 2 distinct, erect, slender, more or less curved teeth
  - 110. *B. posticum***
- b. Lip adaxially near the base with or without two rounded knobs . . . . . 3
- 3a. Rhizomes creeping over the substratum. Most of the rhizome nodes in between the pseudobulbs with roots sprouting from them (Series A, 104. *B. exiguum* included) . . . . . 4
- b. Rhizomes erect to pendulous, growing away from the substratum. Rhizome nodes in between the pseudobulbs without roots (more recently developed shoots often without any roots at all) (Series B, 110. *B. posticum* included) . . . . . 8
- 4a. Inflorescence with 3 flowers or more . . . . . **103. *B. cylindrobulbum***
- b. Inflorescence with 1 or 2 flowers . . . . . 5
- 5a. Pedicel and ovary 4 mm or shorter . . . . . 6
- b. Pedicel and ovary longer than 4 mm . . . . . 7
- 6a. Inflorescence with 1 flower; peduncle longer than 10 mm . . . . . **105. *B. laxum***
- b. Either inflorescence with 2 flowers; or inflorescence with one flower but then peduncle shorter than 5 mm . . . . . **103. *B. cylindrobulbum***
- 7a. (5) Pollinia 4 (take care to check a fully developed flower and look carefully at a magnification of  $\times 30$  or more: the inner pair may be small and thin)
  - 103. *B. cylindrobulbum***
- b. Pollinia 2 . . . . . **106. *B. manobulbum***
- 8a. (3) Sepals long-acuminate to caudate . . . . . **108. *B. cavibulbum***
- b. Sepals rounded to acute, or apiculate . . . . . 9
- 9a. All inflorescences with 1 flower; no aborted second flower protruding from the floral bract . . . . . **107. *B. bigibbum***
- b. At least one inflorescence with 2 flowers or more present; or all inflorescences with 1 flower, but then an aborted second flower is protruding from the floral bract
  - 109. *B. ochroleucum***

**Series A**  
Rhizomes creeping.

**103. *Bulbophyllum cylindrobulbum* Schltr. — Figs. 133, 134; Plate 6d.**

- Bulbophyllum cylindrobulbum* Schltr. in Schum. & Laut., Nachtr. (1905) 200; Fedde, Rep. Beih. 1 (1913) 737; 21 (1928) f. 924. — Type: Schlechter 13999 (B, †). Neotype: Reeve 1015 (K, L).
- Bulbophyllum microcharis* Schltr. in Schum. & Laut., Nachtr. (1905) 209; Fedde, Rep. Beih. 1 (1913) 732; 21 (1928) f. 914. — Type: Schlechter 14472 (B, †).
- Bulbophyllum govidjoae* Schltr., Fedde, Rep. Beih. 1 (1913) 734; 21 (1928) f. 918. — Type: Schlechter 19749 (B, †).
- Bulbophyllum imitans* Schltr., Fedde, Rep. Beih. 1 (1913) 734; 21 (1928) f. 919. — Type: Schlechter 19771 (B, †).
- Bulbophyllum pallidiflavum* Schltr., Fedde, Rep. Beih. 1 (1913) 735; 21 (1928) f. 920. — Type: Schlechter 16475 (holo B, †; iso E, K, L, NY, S).
- Bulbophyllum uduense* Schltr., Fedde, Rep. Beih. 1 (1913) 735; 21 (1928) f. 921. — Type: Schlechter 19904 (holo B, †; iso AMES, BO, L).
- Bulbophyllum kempterianum* Schltr., Fedde, Rep. Beih. 1 (1913) 736; 21 (1928) f. 922. — Type: Schlechter 19037 (B, †).
- Bulbophyllum ferruginescens* Schltr., Fedde, Rep. Beih. 1 (1913) 736; 21 (1928) f. 923. — Syntypes: Schlechter 17352, 18989 (B, †; iso BM, K), 19119 (B, †).
- Bulbophyllum perlongum* Schltr., Fedde, Rep. Beih. 1 (1913) 737; 21 (1928) f. 925. — Type: Schlechter 18701 (B, †).
- Bulbophyllum remotum* J.J. Smith, Nova Guinea 12, 1 (1913) 87. — Type: Gjellerup 563 (BO).
- Bulbophyllum angiose* J.J. Smith, Nova Guinea 12, 4 (1916) 403. — Type: Gjellerup 1119 (BO).
- Bulbophyllum constrictilabre* J.J. Smith, Nova Guinea 12, 4 (1916) 405. — Syntypes: Pulle 887 (BO, K, L), 940 (BO, K, L, U), 940a (L).
- Bulbophyllum longiserpens* Schltr., Engl., Bot. Jahrb. 58 (1923) 138. — Type: Ledermann 11017 (B, †).
- Bulbophyllum sculptum* J.J. Smith, Nova Guinea 14, 3 (1929) 464. — Type: Lam 1767 (BO).
- Bulbophyllum acutibrachium* J.J. Smith, Nova Guinea 14, 3 (1929) 466. — Type: Lam 1952 (BO, L).
- Bulbophyllum disjunctibulbum* J.J. Smith, Nova Guinea 14, 3 (1929) 467. — Type: Lam 1541 (L).
- Bulbophyllum subalpinum* P. Royen, Alpine Fl. New Guinea 2 (1979) 180. — Type: Brass 9229 (AMES, BM, BO, L).
- Bulbophyllum cordilabium* P. Royen, Alpine Fl. New Guinea 2 (1979) 185. — Type: ANU 7277 (Wade) (AMES, CANB, L, LAE).

*Rhizome* creeping, 0.4–5.5 mm diam. *Roots* present along the entire rhizome. *Pseudobulbs* orbicular, ovoid, ellipsoid, or cylindrical, 0.6–30 cm apart, 0.3–6 by 0.2–1.2 cm, not to moderately flattened. *Petiole* 8–130 mm. *Leaf blade* ovate to elliptic, 0.6–17 by 0.3–5 cm, index 2–17, tip rounded to acute. *Inflorescences* single, or few to many together on a short sympodium, 0.8–28 cm, 1–25-flowered. *Peduncle* 0.3–16 cm; bracts 3–7, the longest 1.8–13 mm. *Rachis*, if present, erect or arching, 0.15–13 cm. *Floral bracts* ovate to elliptic, 2–10 mm, tip obtuse to acute. *Pedicel and ovary* 1.7–15 mm, with the node 0.3–3.2 mm from the floral bract. *Flowers* scattered, 1 to many open at the time, moderately to widely opening. *Median sepal* ovate to elliptic, 4–14(–18) by 1.5–4 mm, index 1.8–5.5, tip acute; (rather) thin; glabrous. *Lateral sepals* oblique, 4.2–15(–18) by 1.8–3.6 mm, index 2–6, otherwise as the median sepal. *Petals* oblique, ovate to elliptic, 1.6–5 by 1.2–2.8 mm, index 1.1–2.5, tip rounded to acute; margins glabrous to finely papillose or erose; thin; surface glabrous; adx. somewhat papillose towards the tip or not. *Lip* (moderately) curved, general outline ovate, elliptic, or almost rectangular, (slightly)

constricted approx. half-way, 1.5–5 by 0.8–2 mm, index 1.3–2.8 (not spread), tip obtuse to acute; (rather) thick; glabrous; adx. concave and with 2 inconspicuous to distinct knobs near the base, with or without 2 inconspicuous to distinct ridges converging in front, often convex towards the tip, abx. with an inconspicuous to distinct, retuse median ridge. *Column* from ovary to the tip of the stelia 0.8–2.2 mm; stigma not or hardly protruding at its base, slit-like. *Stelidia* absent or inconspicuous, if present semi-elliptic to triangular, tip rounded to acute; upper margin often erose, or with a an inconspicuous to distinct, rounded to acute tooth along the upper margin. *Anther* abx. with a ridge towards its base; front margin protruding. *Pollinia* 4, rarely 2; the inner pair c. half as long as the outer pair or less, sometimes inconspicuous.

Colours – Flowers generally (pale or greenish) yellow, sometimes white, or orange or brownish yellow, or suffused with red, or entirely dark red or (red-)purple.

Ecology – Epiphyte in primary forest, isolated trees or montane shrubbery. Also observed in secondary forest, in a coconut palm, or as a terrestrial on the sandy shore of a lake. Alt. 0–3200 m, most records higher than 1000 m alt. Flowering 7–9 in lowland areas, less seasonal at higher altitudes, all year round above 2000 m alt.

Distribution – INDONESIA & PAPUA NEW GUINEA. Biak; New Guinea (widespread but not in the southern lowlands); New Britain. – SOLOMON ISLANDS. New Georgia; San Cristobal.

Notes – 1. In this species the size of all parts, the number of flowers per inflorescence, the index of the sepals, as well as the outline of the lip are subject to variability. Several different entities can be recognized. However, these entities are all linked by intermediate specimens. Besides, a number of specimens remain which cannot be assigned to any entity because they are extreme in one or a few characters, such as the length of the inflorescence or the size of the flowers. Therefore the entities have not been given any taxonomical status. The following can be recognized:

- a. Entity '*cylindrobulbum*': Plants medium-sized to large. Rhizome 2–5.5 mm diam. Pseudobulbs 2–5.5 cm long, cylindrical. Leaves 6–15 cm long. Inflorescence 7–20 cm long, sturdy, 12–25-flowered. *Rachis* straight. Sepals 4.5–8 mm long, index 1.8–2.8. Lip slightly constricted approx. half-way. The types of *Bulbophyllum cylindrobulbum* and *B. kempterianum* belong here. See Fig. 133.
- b. Entity '*remotum*': Plants medium-sized to large. Rhizome 1.2–5.5 mm diam. Pseudobulbs 2.5–5.5 cm long, cylindrical. Leaves 3–17 cm long. Inflorescence 3.5–8 cm long, slender, 3–9-flowered. *Rachis* flexuous. Sepals 4–8 mm long, index 2–3.6. Lip slightly constricted approx. half-way. The types of *Bulbophyllum remotum*, *B. angiense*, *B. pallidiflavum* and *B. uduense* belong here. See Fig. 134d.
- c. Entity '*constrictilabre*': Plants small to medium sized. Rhizome 0.6–2 mm diam. Pseudobulbs 0.4–3 cm long, orbicular or ovoid to cylindrical. Leaves 1.2–10 cm long. Inflorescence 1.6–9 cm long, slender, 2–6 flowered. *Rachis* straight or flexuous. Sepals 4–14 mm long, index 1.8–5.5. Lip moderately to distinctly constricted half-way. The types of *Bulbophyllum constrictilabre*, *B. govidjoae*, *B. imitans*, *B. acutibrachium*, *B. subalpinum* and *B. cordilabium* belong here. See Fig. 134a, c, e, h, i, k.

J.J. Smith's illustration of *Bulbophyllum acutibrachium* is inaccurate in the shape of the teeth along the lower margins of the stelia. These are rounded, not acute as drawn by him. Van Royen's drawings of the lip of *B. cordilabium* are inaccurate as a result of wrong interpretation of shrivelled herbarium material.

d. Entity '*microcharis*': Plants small. Rhizome 0.4–0.8 mm diam. Pseudobulbs 0.4–0.7 cm long, orbicular to ovoid. Leaves 0.6–1.3 cm long. Inflorescence 0.8–1.3 cm long, slender or sturdy, 1–3-flowered. Rachis straight or flexuous. Sepals 4.2–5 mm long, index 2–2.3. Lip moderately to distinctly constricted approx. half-way. The type of *Bulbophyllum microcharis* belongs here. See Fig. 134b, f, g, j.

The type material of *Bulbophyllum ferruginescens* and *B. longiserpens* is intermediate between entity a and b, the latter is aberrant in having a rather long but lax inflorescence.

The type of *Bulbophyllum sculptum* is intermediate between c and d.

The type of *Bulbophyllum perlongum* (Schlechter 18701, not seen) fits more or less in entity a or b but has an extremely long inflorescence and very large flowers (sepals c. 18 mm long). However, it is linked to the bulk of the material by the specimen Brass 10267, which has sepals of 14 mm long and which otherwise best fits into entity c.

The type of *Bulbophyllum disjunctibulbum* (Lam 1541) is, apart from its rather long inflorescence, different in having almost triangular sepals.

2. Most specimens have 4 pollinia per flower. However, in specimens fitting into entity b, the inner pair may be thin and difficult to observe. In a single specimen only 2 pollinia were found.

In specimens of entity c and d 4 distinct pollinia are always present. Specimens occur within these entities which are rather similar to *Bulbophyllum manobulbon*, which is characterized by having only 2 pollinia per flower.

3. The delimitation between *Bulbophyllum cylindrobulbum* and *B. ochroleucum* may in some cases be problematical; read also note 4 under the latter species.

#### 104. *Bulbophyllum exiguum* F. Muell. – Fig. 135.

*Bulbophyllum exiguum* F. Muell., *Fragm. Phyt. Austr.* 2 (1860) 72; Dockrill, *Austr. Indig. Orch.* 1 (1969) 576. – *Dendrobium exiguum* (F. Muell.) F. Muell., *Fragm. Phyt. Austr.* 5 (1865) 95. – *Phyllorchis exigua* (F. Muell.) O. Kuntze, *Rev. Gen. Pl.* 2 (1891) 677 (incorrect name). — Syntypes: Shepherd s.n. (lecto MEL, designated by Clements, 1989, not seen), Woolls s.n. (not seen), Beckler s.n. (iso U).

*Dendrobium caleyi* Cunn., *Bot. Mag. Comp.* 2 (1837) 377, nom. prov.

*Rhizome* creeping, 0.5–1.2 mm diam. *Roots* present along the entire rhizome, but mainly under the pseudobulbs. *Pseudobulbs* orbicular to ovoid, 0.5–4 cm apart, 0.4–1 by 0.3–0.6 cm, not flattened. *Petiole* 0.8–5 mm. *Leaf blade* elliptic to obovate, 0.9–3.5 by 0.4–0.8 cm, index 2.2–7, tip (sub)acute. *Inflorescences* usually single, 2–5.5 cm, 2–4-flowered. *Peduncle* 1.6–3.5 cm; bracts 3–4, the longest 2–3 mm. *Rachis* erect to arching, 0.4–2 cm. *Floral bracts* ovate, c. 1.2 mm, tip acute to acuminate. *Pedicel and ovary* 4–9 mm, with the node 0.5–2 mm from the floral bract. *Flowers* scattered, approx. all open at the time, moderately opening. *Median sepal* ovate, 3–5 by 1–1.8 mm, index 2.2–3.5, tip acute; thin; glabrous. *Lateral sepals* oblique, ovate, 3–5 by 1.5–2.5 mm, index 1.8–2.3, otherwise as the median sepal. *Petals* oblique, ovate to elliptic, 1.8–2.5 by 1–1.5 mm, index 1.2–2.2, tip obtuse to subacute; margins glabrous or erose towards the tip, thin; surface glabrous. *Lip* curved at the base, general outline approx. ovate, slightly constricted in the basal half, 2.8–4 by 1.8–1.4 mm, index 2.5–3.5 (not spread), tip obtuse; rather thick; glabrous; adx. distinctly concave and often with an inconspicuous median ridge near

the base, slightly convex towards the tip, abx. with a distinct, retuse median ridge. *Column* from ovary to the tip of the stelia 1–1.4 mm; stigma not protruding at its base, obovate. *Stelidia* inconspicuous, triangular, tip acute. *Anther* abx. with a ridge towards its base; front margin somewhat protruding. *Pollinia* 2.

Colours – Sepals and petals pale green, yellowish or whitish. Lip pale yellow.

Ecology – Rainforest, more open (drier) forest, as an epiphyte or a lithophyte on sandstone rock. Alt. 0–1000 m asl. Flowering mainly 3–5 (After Dockrill, 1969).

Distribution – AUSTRALIA. Queensland (SE part); New South Wales.

Notes – 1. More information on this species can be found in Dockrill (1969), as well as in Clements (Austr. Orch. Research 1, 1989, 14–19). The data given here have been completed from these sources.

2. Well characterized by the lip which, compared with the length of the median sepal, is longer than in the other species of sect. *Uncifera*.

### 105. *Bulbophyllum laxum* Schltr. – Fig. 136.

*Bulbophyllum laxum* Schltr. in Schum. & Laut., Nachtr. (1905) 205; Fedde, Rep. Beih. 1 (1913) 733; 21 (1928) f. 915. — Type: Schlechter 13942 (holo B, †; iso BM, BO, K, P).

*Bulbophyllum trichopus* Schltr., Fedde, Rep. Beih. 1 (1913) 733; 21 (1928) f. 916. — Type: Schlechter 19870 (B, †).

*Rhizome* creeping, 0.5–1 mm diam. *Roots* present along the entire rhizome. *Pseudobulbs* ovoid to ellipsoid, 0.8–10 cm apart, 0.7–1.5 by 0.2–0.4 cm, hardly flattened. *Petiole* 1–2 mm. *Leaf blade* ovate to elliptic, 3–8.5 by 0.4–0.7 cm, index 6–15, tip obtuse to acute. *Inflorescences* usually single, rarely few together on a short sympodium, 1.5–3.5 cm, 1-flowered. *Peduncle* 1.1–2.8 cm; bracts 3–4, the longest 3–3.8 mm. *Floral bracts* elliptic, 2.5–3.5 mm, tip (sub)acute. *Pedicel and ovary* 2–3.2 mm, with the node 0.3–0.4 mm from the floral bract. *Flowers* moderately opening. *Median sepal* ovate, 3.8–5 by 1–2.2 mm, index 2.3–3.8, tip (sub)acute; thin; glabrous. *Lateral sepals* oblique, ovate, 3–5 by 1.2–2 mm, index 2.2–3.4, otherwise as the median sepal. *Petals* (hardly) oblique, ovate to elliptic, 1.5–2 by 0.6–0.9 mm, index 2–2.6, tip (sub)acute; thin; glabrous. *Lip* strongly curved, general outline ovate to approx. rectangular, often slightly constricted approx. half-way, 0.6–1.4 by 0.6–1.1 mm, index 1.6–1.8 (not spread), tip obtuse to acute; rather thick; glabrous; adx. moderately concave and with 2 very inconspicuous knobs near the base, slightly convex towards the tip, abx. with an inconspicuous, retuse median ridge. *Column* from ovary to the tip of the stelia 0.5–1 mm; stigma not protruding at its base, obovate. *Stelidia* inconspicuous, triangular, tip obtuse to acute; with an inconspicuous to distinct, obtuse to acute tooth along the upper margin. *Anther* abx. with an inconspicuous ridge towards its base; front margin protruding. *Pollinia* 4, sometimes 2; the inner pair, if present, less than half as long as the outer pair, often inconspicuous.

Colours – Flowers white.

Ecology – Epiphyte in primary forest. Alt. 200–1400 m asl. Flowering observed in 1, 6, 10.

Distribution – PAPUA NEW GUINEA. New Guinea (Ramu R. basin; Huon Peninsula; Wharton Ra.); Bougainville.

Note – Differs mainly from *B. manobulbon* by the longer peduncle, the much shorter pedicel plus ovary and the floral bract which is approx. as long as the pedicel plus ovary or

longer. Specimens of *B. cylindrobulbum* with a 1-flowered inflorescence always have a much shorter peduncle than specimens of *B. laxum* (3–5 mm and 11–28 mm respectively).

### 106. *Bulbophyllum manobulbum* Schltr. – Fig. 137.

*Bulbophyllum manobulbum* Schltr. in Schum. & Laut., Nachtr. (1905) 207; Fedde, Rep. Beih. 1 (1913) 733; 21 (1928) f. 917. — Type: Schlechter 15743 (B, †). Neotype: Schlechter 19005 (BM, K).

*Rhizome* creeping, 0.7–1.5 mm diam. *Roots* present along the entire rhizome. *Pseudobulbs* ovoid to ellipsoid, 1.5–21 cm apart, 0.8–3 by 0.3–1.5 cm, somewhat flattened. *Petiole* 1–6 mm. *Leaf blade* ovate to elliptic, 2–7 by 0.5–2 cm, index 2.8–6, tip obtuse to subacute. *Inflorescences* usually single, sometimes few together on a short sympodium, 1.5–2.8 cm, 1(–2)-flowered. *Peduncle* 0.6–1.0 cm; bracts 2–3, the longest 2–3 mm. *Rachis* if present erect, 0.1–0.2 cm. *Floral bracts* ovate, 2.5–3 mm, tip acute. *Pedicel and ovary* 4.5–10 mm, with the node 0.8–1.3 mm from the floral bract. *Flowers* open at the time (if 2 present), widely opening. *Median sepal* ovate to elliptic, 5.5–8 by 1.7–2.2 mm, index 3–4.2, tip acute; thin; glabrous. *Lateral sepals* slightly oblique, ovate, 6–7.5 by 1.7–2.2 mm, index 3.2–4.6, otherwise as the median sepal. *Petals* hardly oblique, ovate to elliptic, 3–3.8 by 1–1.6 mm, index 2.2–3.3, otherwise as the median sepal. *Lip* strongly curved, general outline ovate, sometimes slightly constricted approx. half-way, 1–1.4 by 1–1.2 mm, index c. 1.2 (not spread), tip obtuse to acute; rather thick; glabrous; adx. moderately concave and with 2 inconspicuous knobs near the base, with 2 inconspicuous ridges converging in front, abx. with an inconspicuous, retuse median ridge. *Column* from ovary to the tip of the stelia 0.8–1.2 mm; stigma hardly protruding at its base, slit-like. *Stelia* inconspicuous, triangular, tip acute; upper margin somewhat irregular. *Anther* abx. with a ridge towards its base; front margin hardly protruding. *Pollinia* 2.

*Colours* – Plant dark green. Sepals and petals pale yellow, either suffused with pale purple or not. Lip yellow, purplish towards the base.

*Ecology* – Epiphyte in primary forest. Also found in a rubber plantation. Alt. 500–1800 m asl. Flowering observed in 1, 3, 7, 9, 12.

*Distribution* – PAPUA NEW GUINEA. New Guinea (central mountain range: Western Highlands Prov. to Bismarck Ra. Also Finisterre Mts). – SOLOMON ISLANDS. New Georgia (?), Wickison 64b, sterile).

*Note* – The differences from *Bulbophyllum laxum* are mentioned under that species. Specimens of *B. cylindrobulbum* with a 1- or 2-flowered inflorescence differ from *B. manobulbum* by having 4, not 2, pollinia. See also note 2 under *B. cylindrobulbum*.

#### Series B

Rhizomes erect, patent or pendulous.

*Note* – The range covered by the measurements of the vegetative parts of the species included in this series represents only partly an existing variability.

Young plants start developing a cluster of relatively small shoots. They then produce one or more long ‘branches’ growing away from the substratum. These start which a number of very stout shoots. When the ‘branches’ have reached a certain length the size of the new shoots decreases quickly, and massive production of flowers starts.

It is difficult to find out which stage is represented by herbarium specimens, which generally consist of cut-off branches, or only parts of branches. The measurements of the vegetative parts in the descriptions simply represent the largest and the smallest measurement found.

**107. *Bulbophyllum bigibbum* Schltr. – Fig. 138.**

*Bulbophyllum bigibbum* Schltr., Bot. Jahrb. 58 (1923) 137. — Type: Ledermann 10123 (holo B, †; iso K, L).

*Rhizome* patent to pendulous, up to 30 cm long, 0.7–1 mm diam. *Roots* present only below the pseudobulbs, along the older parts of the rhizome. *Pseudobulbs* ovoid, 0.5–2 cm apart, 0.3–0.8 by 0.2–0.4 cm, not flattened. *Petiole* c. 1 mm. *Leaf blade* ovate to elliptic, 1–3 by 0.2–0.4 cm, index 4–10, tip acute. *Inflorescences* usually many together on a short sympodium, c. 1 cm, 1-flowered. *Peduncle* c. 0.2 cm; bracts c. 3, the longest c. 1.6–2 mm. *Floral bracts* tubular, 1.2–1.5 mm, tip acute. *Pedicel and ovary* 1.8–3 mm, with the node c. 0.5 mm from the floral bract. *Flowers* widely opening. *Median sepal* ovate to elliptic, 2–4.5 by 1.4–2 mm, index 1.5–2.3, tip subacute; thin; glabrous. *Lateral sepals* oblique, 2–3.8 by 1.5–2 mm, index 1.2–1.9, otherwise as the median sepal. *Petals* slightly oblique, ovate to elliptic, 1.5–2 by 1–1.2 mm, index c. 1.5, tip obtuse; thin; glabrous. *Lip* strongly curved, general outline ovate, 0.8–1.2 by 0.7–1 mm, index 1–1.2 (not spread), tip obtuse; rather thin; glabrous; adx. somewhat concave and with 2 distinct knobs near the base, convex towards the tip; abx. with an inconspicuous, retuse median ridge. *Column* from ovary to the tip of the stelidia c. 0.7 mm; stigma not protruding at its base, slit-like. *Stelidia* absent or inconspicuous, with a distinct, large, obtuse, tooth along the upper margin. *Anther* abx. with an inconspicuous ridge towards its base; front margin protruding. *Pollinia* 4; the inner pair more than half as long as the outer pair.

Colours – Flowers pinkish red with darker red veins.

Ecology – Epiphyte in primary forest. Alt. 1000–2500 m asl. Flowering observed in 12.

Distribution – INDONESIA & PAPUA NEW GUINEA. New Guinea (central mountain range: Jayawijaya Ra.; East Sepik Prov.).

Note – Although of somewhat different appearance, *Bulbophyllum bigibbum* and *B. ochroleucum* are rather similar. The former has 2 knobs near the base of the lip, on the adaxial side, which are much less distinct in the latter. Another difference between the two is that *B. bigibbum* always has 1-flowered inflorescences. This may also occur in *B. ochroleucum* but then an aborted second flower is always protruding from the floral bract.

**108. *Bulbophyllum cavibulbum* J.J. Smith – Fig. 139.**

*Bulbophyllum cavibulbum* J.J. Smith, Nova Guinea 14, 3 (1929) 465. — Type: Lam 1689 (BO).

*Rhizome* erect to patent, up to 30 cm long, 1.8–3 mm diam. *Roots* present only below the pseudobulbs, along the older parts of the rhizome. *Pseudobulbs* ovoid, 1–3.5 cm apart, 0.6–1 by 0.4–0.6 cm, not flattened. *Petiole* 0.5–1.5 mm. *Leaf blade* ovate to elliptic, 1.2–3.2 by 0.6–1 cm, index 2–4.5, tip acute. *Inflorescences* usually many together on a short sympodium, approx. 2 cm, 2-flowered. *Peduncle* c. 0.4 cm; bracts c. 3, the longest 3–4 mm. *Rachis* approx. erect, c. 0.3 cm. *Floral bracts* ovate, 6–8 mm, tip

acute. *Pedicel and ovary* 4–5 mm, with the node c. 1 mm from the floral bract. *Flowers* distichous, scattered, both open at the time, moderately opening. *Median sepal* ovate, 15–21 by 0.3–0.4 mm, index 5–6, tip long acuminate to caudate; margins somewhat papillose; rather thin; surface glabrous. *Lateral sepals* oblique, otherwise as the median sepal. *Petals* hardly oblique, ovate to elliptic, 4.2–5.5 by 2.2–3 mm, index c. 2, tip acute; rather thin; glabrous. *Lip* curved, general outline ovate, 3.8–4.5 by 1.5–2 mm, index 2–2.5 (not spread), tip subacute; rather thick; approx. glabrous; adx. moderately concave and with 2 inconspicuous knobs near the base, with 2 inconspicuous ridges converging in front, abx. with a distinct, retuse median ridge. *Column* from ovary to the tip of the stelia c. 1.5 mm; stigma not protruding at its base, slit-like. *Stelidia* inconspicuous, triangular, tip subacute; upper margin somewhat irregular. *Anther* abx. with a ridge towards its base; front margin protruding. *Pollinia* 4; the inner pair approx. half as long as the outer pair.

Colours – Pseudobulbs red-brown or purple. Leaves dark purplish or brownish green adx., paler abx. Inflorescence and flowers pale red or yellowish, suffused with red.

Ecology – Epiphyte in woody vegetation. Also as a terrestrial. Alt. 3200–3300 m asl. Flowering observed in 10, 11.

Distribution – INDONESIA. New Guinea (Sudirman Ra.).

Notes – Among the species of sect. *Uncifera* with the rhizome growing away from the substratum *B. cavibulbum* is characterized by its long-acuminate to caudate sepals.

### 109. *Bulbophyllum ochroleucum* Schltr. – Fig. 140.

*Bulbophyllum ochroleucum* Schltr. in Schum. & Laut., Nachtr. (1905) 212; Fedde, Rep. Beih. 1 (1913) 738; 21 (1928) f. 927. — Type: Schlechter 14047 (holo B, †; iso BM, K, P).

*Bulbophyllum ramosum* Schltr. in Schum. & Laut., Nachtr. (1905) 214; Fedde, Rep. Beih. 1 (1913) 738; 21 (1928) f. 926. — Type: Schlechter 14043 (B, †).

*Bulbophyllum rostratum* J.J. Smith, Bull. Dép. Agr. Ind. Néerl. 19 (1908) 8; Nova Guinea 8, 1 (1911) 98. — Syntypes: Versteeg 1333 (BO), 1562 (BO, L).

*Bulbophyllum furciferum* J.J. Smith, Nova Guinea 12, 4 (1916) 404; Bull. Jard. Bot. Buitenzorg II, 13 (1914) 69. — Type: Gjellerup 1069 (BO, L).

*Bulbophyllum adpressiscapum* J.J. Smith, Nova Guinea 12, 4 (1916) 402. — Type: Pulle 962 (BO).

*Bulbophyllum piundensis* P. Royen, Alpine Fl. New Guinea 2 (1979) 183. — Type: Van Balgooij 64 (CANB, L, LAE).

*Rhizome* erect to pendulous, up to 80 cm long, 1–3.5 mm diam. *Roots* present only below the pseudobulbs, generally only along the older parts of the rhizome (occasionally a few roots may grow from under recently developed pseudobulbs). *Pseudobulbs* (narrowly) ovoid to approx. cylindrical, 0.5–9 cm apart, 0.6–2.2 by 0.2–0.7 cm, not or hardly flattened. *Petiole* 1–7 mm. *Leaf blade* ovate to elliptic, 2.2–13 by 0.3–3 cm, index 3–10, tip obtuse to acute. *Inflorescences* single or few together on a short sympodium, 0.6–9 cm, 1–9-flowered. *Peduncle* 0.8–3 cm; bracts 3, the longest 3.5–6(–9) mm. *Rachis* erect or arching, 1–6 cm. *Floral bracts* ovate, 2.5–7 mm, tip obtuse to acute. *Pedicel and ovary* 2–7(–12) mm, with the node 0.5–1.4(–3) mm from the floral bract. *Flowers* scattered (sometimes seemingly distichous), 1 to many open at the time, moderately to widely opening. *Median sepal* ovate to elliptic, 3–8(–13) by 1.5–4(–6) mm, index 1.6–3.8, tip obtuse to acute; (rather) thin; approx. glabrous. *Lateral sepals* oblique, 3–8(–13) by 1.5–3.5(–6) mm, index 1.6–3.8, otherwise as the median sepal. *Petals* oblique, ovate to elliptic, 1–4



by 0.5–2.8 mm, index 1–3, tip rounded to acute; margins glabrous or finely papillose to erose towards the tip; thin; surface glabrous; adx. sometimes finely papillose towards the tip. *Lip* strongly curved, general outline ovate, to approx. rectangular, either constricted approx. half-way or not, 1–2.5(–4) by 0.6–1.2(–2) mm, index 1.5–2.5 (not spread), tip rounded to obtuse; (rather) thick; approx. glabrous; adx. concave and with 2 inconspicuous to distinct knobs near the base, generally with 2 inconspicuous ridges converging in front, abx. with an inconspicuous, retuse median ridge. *Column* from ovary to the tip of the steli-dia 0.5–1.5(–2.6) mm; stigma not or hardly protruding at its base, approx. slit-like. *Stelidia* absent or inconspicuous, if present semi-elliptic to triangular, tip rounded to acute; upper margin often erose, or with a an inconspicuous to distinct, rounded to acute tooth along the upper margin. *Anther* abx. with a ridge towards its base; tip; front margin somewhat protruding. *Pollinia* 2 or 4; the inner pair if present c. half as long as the outer pair.

Colours – Plant medium green. Flowers orange, yellow or white. Lip sometimes in a darker shade than the sepals and the petals, or with the base suffused with red.

Ecology – Epiphyte in primary or secondary forest, and shrubby montane vegetation. Sometimes as a terrestrial along footpaths, streams etc, in moss-covered soil. Alt. 800–3200(–3500) m asl. Flowering mainly 1–6, 10–12.

Distribution – INDONESIA & PAPUA NEW GUINEA. New Guinea (widespread, but mainly in central mountain range; not in the southern lowlands. Also Chendrawasih Peninsula); New Ireland.

Notes – 1. *Bulbophyllum ochroleucum* is rather similar to *B. bigibbum*; see the note under that species.

2. The size of the plant and the flowers, as well as the length of the inflorescences show an extreme variability. Most specimens seen have rather small flowers and short inflorescences but, just as in *Bulbophyllum cylindrobulbum*, incidentally specimens with extremely large flowers or an unusually long inflorescence occur.

3. Generally 2 pollinia are present per flower in *Bulbophyllum ochroleucum*. However, in specimens with 1- or 2-flowered inflorescences often (but not always) 4 pollinia are present, e. g. in the types of *B. furciferum* and *B. adpressiscapum*.

4. The specimen Van Balgooij 64 (type of *Bulbophyllum piundensis*, found at the extreme altitude of 3500 m asl.) differs slightly in having a rather sinuous rhizome as well as a narrow lip. Many fruits are present on the specimen, and in one flower the pollinia were found sagging through the rostellum and growing into the stigma. It may well represent an autogamous population. Like a few other specimens originating from high altitudes, it tends to develop some roots along the younger parts of the rhizome, although it has a straggling, not creeping growth habit. Since the position of the roots is a diagnostic difference between *B. ochroleucum* and *B. cylindrobulbum*, similar specimens may be difficult to identify in some cases, particularly when no field observations on growth habit are available.

## 110. *Bulbophyllum posticum* J.J. Smith – Fig. 141.

*Bulbophyllum posticum* J.J. Smith, Bull. Jard. Bot. Buitenzorg II, 2 (1911) 19; Nova Guinea 12, 1 (1913) 90. — Type: De Kock 202 (holo BO; iso L).

*Bulbophyllum dicerus* Schltr., Fedde, Rep. Beih. 1 (1913) 739; 21 (1928) f. 928. — Type: Schlechter 20326 (holo B, †; iso AMES, L).

*Bulbophyllum bicornutum* Schltr., Bot. Jahrb. 58 (1923) 137. — Type: Ledermann 11452 (B, †).

*Rhizome* creeping, or erect to pendulous, up to 60 cm long, 1–4 mm diam. *Roots* present only below the pseudobulbs, generally only along the older parts of the rhizome (occasionally a few roots may grow from below recently developed pseudobulbs). *Pseudobulbs* (narrowly) ovoid to orbicular, sometimes with very distinct, projecting ribs, 1–6 cm apart, 0.3–2.0 by 0.3–1.3 cm, not flattened. *Petiole* 1–5 mm. *Leaf blade* ovate to elliptic, 1.8–6 by 0.4–1 cm, index 3–15, tip acute. *Inflorescences* usually many together on a short sympodium, 0.7–1.6 cm, 1-flowered. *Peduncle* 0.2–0.6 cm; bracts 3–4, the longest 3.5–5 mm. *Floral bracts* tubular, 2–4 mm, tip acute to apiculate. *Pedicel and ovary* 3.5–6 mm, with the node 0.5–1.2 mm from the floral bract. *Flowers* widely opening. *Median sepal* ovate to elliptic, 5.5–9 by 2–4 mm, index 1.7–2.8, tip obtuse to acute; thin; glabrous. *Lateral sepals* slightly oblique, 5.5–8 by 2.5–5 mm, index 1.4–2.3; otherwise as the median sepal. *Petals* slightly oblique, 2.5–6 by 1.5–3.5 mm, index 1.6–1.9, tip rounded to acute; otherwise as the median sepal. *Lip* strongly curved, general outline ovate to elliptic, constricted approx. half-way, 1.5–4 by 0.8–3 mm, index 1–1.8 (not spread), tip obtuse to acute; rather thin; glabrous; adx. somewhat concave and with 2 distinct, erect, slender, more or less curved teeth near the base, convex towards the tip; abx. with an inconspicuous, retuse median ridge. *Column* from ovary to the tip of the stelia 1–1.7 mm; stigma not protruding at its base, slit-like. *Stelidia* absent or inconspicuous, margins sometimes with irregular teeth. *Anther* abx. with an inconspicuous ridge towards its base; front margin somewhat protruding. *Pollinia* 4; the inner pair more than half as long as the outer pair.

**Colours** – Pseudobulbs dark green to brownish or reddish. Leaves medium to dark green. Sepals and petals white or pale yellowish, with or without dark red-purple veins; occasionally entirely brownish red. Lip red-purple, the teeth at its base white.

**Ecology** – Epiphyte in primary forest. Also found as a lithophyte. Alt. 800–2800 m asl. Flowering 1–5 and 8–12.

**Distribution** – INDONESIA & PAPUA NEW GUINEA. New Guinea (central mountain range from Yaramaniapuka Ra. to Wharton Ra. Also mountain ranges N of Sepik R.).

**Notes** – 1. Well characterized by the very distinct teeth at the base of the lip.

2. Some specimens have distinctly protruding, almost winglike ribs on the pseudobulbs. Otherwise they do not differ from specimens not showing this character.

#### INCOMPLETELY KNOWN SPECIES

##### ***Bulbophyllum sarasinorum* Schltr.**

*Bulbophyllum sarasinorum* Schltr., Fedde, Rep. 21 (1925) 189. — Type: Sarasin & Sarasin 2144 (B, †).

**Note** – The type, originating from Sulawesi, was destroyed. No material which can be attributed to this species has been seen by the author. According to Schlechter's description it should be more or less similar to *Bulbophyllum laxum*, *B. manobulbum* or *B. cylindrobulbum* entity '*microcharis*'.

### 13. IDENTIFICATION LIST

This identification list includes all collections examined for this revision. The identifications are given as numbers between brackets. These numbers correspond with the species numbers in the revision. To facilitate the use of this list, an enumeration of the taxa with their numbers is given.

#### ***Bulbophyllum* section *Adelopetalum***

- 1 *argyropus* (Endl.) Reichb. f.
- 2 *boonjee* Gray & Jones
- 3 *bracteatum* F. M. Bailey
- 4 *elizae* (F. Muell.) Benth.
- 5 *lageniforme* F. M. Bailey
- 6 *lilianae* Rendle
- 7 *lingulatum* Rendle
- 8 *newportii* (F. M. Bailey) Rolfe

#### ***Bulbophyllum* section *Lepanthanthe***

- 9 *cruttwellii* J. J. Vermeulen
- 10 *inquirendum* J. J. Vermeulen
- 11 *lepanthiflorum* Schltr.
- 12 *leptophyllum* Kittredge
- 13 *antennatum* Schltr.
- 14 *erinaceum* Schltr.
- 15 *nephropetalum* Schltr.
- 16 *toranum* J. J. Smith
- 17 *baculiferum* Ridley
- 18 *bulliferum* J. J. Smith
- 19 *parabates* J. J. Vermeulen
- 20 *quasimodo* J. J. Vermeulen
- 21 *thersites* J. J. Vermeulen
- 22 *trachypus* Schltr.

#### ***Bulbophyllum* section *Macrouris***

- 23 *grammopoma* J. J. Vermeulen
- 24 *sceliphron* J. J. Vermeulen
- 25 *callichroma* Schltr.
- 26 *cardiophyllum* J. J. Vermeulen
- 27 *cateorum* J. J. Vermeulen
- 28 *chloranthum* Schltr.
- 29 *dekokkii* J. J. Smith
- 30 *dendrochiloides* Schltr.
- 31 *fonsflorum* J. J. Vermeulen
- 32 *graciliscapum* Schltr.
- 33 *kaniense* Schltr.
- 34 *levatii* Kränzlin
  - a subsp. *levatii*
  - b subsp. *mischanthum* J. J. Vermeulen
- 35 *macrourum* Schltr.
- 36 *mulderae* J. J. Vermeulen
- 37 *muscicola* Schltr.
- 38 *myon* J. J. Vermeulen
- 39 *olivinum* J. J. Smith
  - a subsp. *olivinum*
  - b subsp. *linguiferum* J. J. Vermeulen
- 40 *orbiculare* J. J. Smith
  - a subsp. *orbiculare*
  - b subsp. *cassideum* (J. J. Smith)
- 41 *oreodoxa* Schltr. [J. J. Vermeulen]
- 42 *phormion* J. J. Vermeulen
- 43 *pidacanthum* J. J. Vermeulen
- 44 *scopa* J. J. Vermeulen

- 45 *trifilum* J. J. Smith
  - a subsp. *trifilum*
  - b subsp. *filisepalum* (J. J. Smith)
- 46 *desmotrichoides* Schltr. [J. J. Vermeulen]
- 47 *dichotomum* J. J. Smith
- 48 *glaucum* Schltr.
- 49 *imitator* J. J. Vermeulen

#### ***Bulbophyllum* section *Pelma***

- 50 *absconditum* J. J. Smith
  - a subsp. *absconditum*
  - b subsp. *hastula* J. J. Vermeulen
- 51 *ankylorhinon* J. J. Vermeulen
- 52 *bacilliferum* J. J. Smith
- 53 *colliferum* J. J. Smith
- 54 *fractiflexum* J. J. Smith
  - a subsp. *fractiflexum*
  - b subsp. *solomonense* J. J. Vermeulen & [Lewis]
- 55 *gyaloglossum* J. J. Vermeulen [Lewis]
- 56 *latipes* J. J. Smith
- 57 *leptoleucum* Schltr.
- 58 *leucothysus* Schltr.
- 59 *macilentum* J. J. Vermeulen
- 60 *melanoxanthum* J. J. Vermeulen & Lewis
- 61 *mesodon* J. J. Vermeulen
- 62 *mischobulbon* Schltr.
- 63 *ochthochilum* J. J. Vermeulen
- 64 *oliganthum* Schltr.
- 65 *pachytelos* Schltr.
- 66 *savaiense* Schltr.
  - a subsp. *savaiense*
  - b subsp. *gorumense* (Schltr.) J. J. Vermeulen
  - c subsp. *subcubicum* (J. J. Smith)
- 67 *simile* Schltr. [J. J. Vermeulen]
- 68 *stipulaceum* Schltr.
- 69 *tanystiche* J. J. Vermeulen
- 70 *xanthochlamys* Schltr.

#### ***Bulbophyllum* section *Peltopus***

- 71 *aechmophorum* J. J. Vermeulen
- 72 *alveatum* J. J. Vermeulen
- 73 *ankylochele* J. J. Vermeulen
- 74 *aphanopetalum* Schltr.
- 75 *artostigma* J. J. Vermeulen
- 76 *bliteum* J. J. Vermeulen
- 77 *brachypetalum* Schltr.
- 78 *brassii* J. J. Vermeulen
- 79 *calviverter* J. J. Vermeulen
- 80 *cycloglossum* Schltr.
- 81 *discolor* Schltr.
  - a subsp. *discolor*
  - b subsp. *cubitale* J. J. Vermeulen
- 82 *hiljeae* J. J. Vermeulen
- 83 *inciferum* J. J. Vermeulen
- 84 *intersium* J. J. Vermeulen
- 85 *kenae* J. J. Vermeulen

86 *lophoton* J.J. Vermeulen  
 87 *loroglossum* J.J. Vermeulen  
 88 *minutipetalum* Schltr.  
 89 *octarrhenipetalum* J.J. Smith  
 90 *origami* J.J. Vermeulen  
 91 *ortialis* J.J. Vermeulen  
 92 *patella* J.J. Vermeulen  
 93 *peltopus* Schltr.  
 94 *plicatum* J.J. Vermeulen  
 95 *ptychantyx* J.J. Vermeulen  
 96 *reevei* J.J. Vermeulen  
 97 *rhodoleucum* Schltr.  
 98 *santoense* J.J. Vermeulen  
 99 *scutiferum* J.J. Vermeulen

100 *subapetalum* J.J. Smith  
 101 *systemochilum* J.J. Vermeulen  
 102 *thelantyx* J.J. Vermeulen

***Bulbophyllum* section *Uncifera***

103 *cylindrobulbum* Schltr.  
 104 *exiguum* F. v. Muell.  
 105 *laxum* Schltr.  
 106 *manobulbum* Schltr.  
 107 *bigibbum* Schltr.  
 108 *cavibulbum* J.J. Smith  
 109 *ochroleucum* Schltr.  
 110 *posticum* J.J. Smith

Aet & Idjan (exp. Van Dijk) 433 (54a); 502 (11) — ANU series: (Wade) 7277 (103); 7578 (42); 7585 (39a); 7589 (109); 7676 (109); (Smith) 15243 (81a); (Hope) 28076 (13); 28078 (35) — Argent s.n., 1972 (29).  
 Backer 11595 (50a) — Bacon 4740 (40a) — van Balgooy 64 (109) — Bauer s.n. (1) — Bauerlen s.n., 1891 (104) — Beauglehole 5765 (1) — Beckler s.n. (104) — Bellenden Kerr Exp. s.n., 1889 (5); (1904) (5) — Bergman 41 (20); 164 (44); 187 (44); 189 (44); 277 (68); 287 (44); 427 (44); 428 (44); 451 (36); 502 (93); 582 (93); 667 (44); 685 (44); 730 (23); 732 (40b); 843 (43) — Bernardi 9483 (74); 9922ii (74); 13239 (32); 13239ii (34a) — Bloembergen 3915 (66c) — Bogor cult. 26 (66c); 64 (54a); 287b (66c); 440r (54a); 442r (66c); 929ii 8 (54a); f88 (66c); f118 (66c); f304 (54a); II MB159 (54a) — Bogor cult.: (Branderhorst) 293 (28); (De Kock 130) (66c); (De Kock 142) (66c); (Pulle 64) (54a); (Rachmat 138) 453 (54a) — Borgmann 721 (39a) — Bourdy 410 (47) — Bowers 429 (109) — Branderhorst 4 (54a) — Brass 2100 (5); 2332 (6); 4562 (66b); 4982 (97); 5454 (41); 5777 (28); 6988 (54a); 6989 (68); 7049 (50b); 7095 (18); 7137 (11); 7195 (66c); 7213 (20); 7248 (66c); 9110 (101); 9229 (103); 9246 (109); 9247 (29); 9272 (101); 9370 (99); 10253 (42); 10266 (109); 10267 (103); 10573 (109); 10624 (65); 10713 (42); 10723 (78); 10779 (47); 10919 (67); 10920 (80); 10935 (67); 10936 (110); 10982 (81a); 10983 (81a); 11008 (39a); 11011 (97); 11086 (40a); 11098 (37); 11245 (37); 11276 (13); 11304 (42); 11442 (71); 11445 (37); 11446 (81a); 11501 (96); 11502 (13); 11506 (37); 12126 (13); 12245 (109); 12262 (40a); 12282 (40a); 12284 (70); 12476 (103); 12714 (90); 13717 (61); 18314 (6); 20103 (6); 20135 (6); 20342 (6); 20344 (8); 22600 (81a); 23001 (103); 23056 (40a); 23095 (13); 23105 (40a); 23106 (40a); 24481 (40a); 24551 (40a); 24738 (40a); 30438 (109); 31478 (66c) — Bregulla 30 (34a) — BW series: (Versteeg) 3016 (103); (Vink & Schram) 8880 (103); (Sleumer & Vink) 14110 (103); 14340a (39a); 15412 (39a).  
 Cabalion 2766 (50a) — Carr 10122 (54a); 10154 (46); 10159 (106); 10252 (37); 10277 (44); 10285 (45a); 10317 (37); 10320 (65); 10321 (67); 10337 (59); 10351 (47); 10363 (57); 10369 (63); 10371 (90); 10380 (40a); 10383 (46); 10397 (54a); 10401 (30); 10404 (54a); 10426 (109); 10460 (97); 10461 (65); 10484 (65); 10489 (109); 10503 (103); 10509 (81a); 10513 (62); 10518 (9); 10537 (65); 10549 (42); 10588 (83); 10618 (11); 10637 (54a); 16667 (24); 16736 (46); 16752 (13); 16754 (13); 16767 (63); 16775 (109); 16797 (103); 16798 (96); 16799 (83); 17044 (81a); 17279 (57); 17291 (37); 17293 (13) — Chadin 149 (58) — Chaplin 831 (40a) — Cheeseman 191 (1) — Clemens 273 (50a); 310a (64); 3454 (103); 4591 (40a); 6634 (105); 7164 (77); 7845 (103); 8975 (37); 12073 (67); 12221 (51); s.n., 1947 (8) — Colenso s.n., 5/1890 (1) — Compton 1818 (7) — Conn 477 (41) — Constable 11902 (104) — Cornelisse s.n., 1/1992 (73) — Coveny 9236 (104); 9371 (104) — Craig 53 (66b); 161 (103) — Crane 355 (104); 369 (104) — Craven & Schodde 137 (60); 282 (47); 1329 (109) — Cribb S182 (81a) — Cribb & Campbell 5121 (40a); 5157 (32) — Cribb, Dennis & Campbell 5047 (34a) — Cribb & Morrison 1821 (34a); 1977 (40a); 2269 (30) — Cribb & Wheatley 27 (34a); 36 (47); 61 (32); 87 (98); 113 (34a) — Cruttwell 708 (109); 803 (40a); 806 (81a); 915 (40a); 1120 (97); 1128 (37); 1483 (109); 1489 (66c); 1493 (58); 1501 (39b); 1514 (30); 1566 (34b); 2069 (13); 2100 (109); 2501 (30); 2502 (38); 2520 (38); 2521 (38); 2564 (109); 2586 (31); 2643 (109); 3060 (85); 3131 (92); 3153 (55); 3162 (40a); 3168 (79); 3176 (97); 3180 (42); 3187 (102); 3188 (39a); 3191 (93); 3196 (92); 3204 (77); 3211 (28); 3213 (38); 3214 (34a); 3215 (34b); 3216 (45b); 3217 (42); 3221 (68); 3225 (42); 3234 (31); 3237 (23); 3238 (93); 3243 (96); 3250 (53); 3262 (54a); 3265 (38); 3267 (81a); 3268 (42); 3275 (76);

3278 (76); 3279 (109); 3283 (35); 3301 (13); 3303 (27); 3304 (91); 3306 (79); 3307 (81a); 3318 (73); 3319 (103); 3323 (66b); 3331 (92); 3338 (76); 3339 (95); 3341 (68); 3343 (86) — Cunningham in Hb. Heward s.n., 1824 (104); s.n., 1833 (104).

Dallachy s.n., 1870 (8) — Derbyshire 237 (35); 249 (34b) — Derbyshire & Hoogland 8282 (54a); 8305 (65); 8330 (20) — Dickson 161 (40b); 203 (40b) — Dockrill 139 (6); 156 (6) — Dockrill & Stevens 371 (5) — Docters van Leeuwen 305 (50a); 10249 (18); 10264 (56); 10335 (18); 10773 (45a); 10976 (109) — Docters van Leeuwen-Reijnvaan 305 (50a) — Domin s.n., 1910 (104).

Edwards MD72 (45a) — Elworthy 75 (31) — Eyma 3089 (40b); 4573 (40a); 4785 (70); 4843 (27); 5005 (40b); 5068 (57); 5162 (10); 5434 (110).

Feuilletau de Bruyn 98 (25); 147 (54a).

Gibbs 5504 (89); 6304 (6) — Gjellerup 552 (40a); 563 (103); 745 (18); 797 (16); 820 (53); 828 (45a); 830 (32); 830 (40a); 844 (45a); 849 (40b); 883 (68); 1068a (109); 1069 (109); 1070 (110); 1090 (89); 1117 (70); 1119 (103); 1239 (79) — Gray 1005a (2) — Green 1057 (34a); 1353 (34a); 2375 (1) — Grubb & Edwards 222 (53) — Guillaumin & Baumann-Bodenheim 12917 (7) — Gyldenstolpe s.n., 10/1951 (81a).

H. B. M. in Rogers s.n., 14/5/1914 (1) — Hartley 12742 (49); 13060 (110); 13160 (37); 14067 (8) — Hewn s.n., 1899 (104) — Hiepko & Schultze-Motel 1176 (30); 1321 (40b); 1323 (57); 1333 (9); 1373 (103); 1438 (30) — Himson 15 (54a) — Hooek s.n., 11/1974 (32) — Hoogland 4437 (41); 9175 (81a); 9188 (109); 9210 (109); 9351 (40a); 9367 (66b); 9369 (77); 9414 (81a); 9566 (66b) — Hoogland & Craven 9336 (67); 10520 (28); 10899 (109); 10923 (50b); 10931 (84) — Howard Newport s.n., 14/4/1908 (8) — Hunt 2203 (54b); 2208 (103); 2225 (54b); 2236 (18); 2984 (40a); 3078 (32) — Hürlimann 1356 (7).

Jacobs 8638 (9) — Janowsky 312 (100); 368 (89); 411 (100); 412 (45b); 418 (89) — Jermy 2 (39a); 14 (81a) — Jessup & Gray 2397 (4) — Jongejan 108 (37); 119 (25); 133 (39a); 145 (30); 166 (66c); 218 (57); 231 (81b); 239 (81b); 249 (34b); 298 (13); 308 (34b); 332 (106); 337 (28); 366 (28); 368 (45b); 372 (54a); 477 (109); 531 (37); 542 (37); 551 (84); 564 (81b); 565 (81a); 605 (28); 607 (53); 639 (68); 648 (68); 662 (65); 690 (37); 695 (87); 706 (102); 719 (81a); 747 (81a); 769 (84); 772 (40b); 773 (14); 785 (30); 789 (93); 795 (84); 798 (93); 802 (97); 804 (38); 807 (57); 822 (76); 864 (3); 938 (50a); 956 (37); 968 (93); 976 (97); 996 (66b); 1009 (30); 1010 (66b); 1014 (109); 1015 (41); 1020 (16); 1029 (34b); 1043 (103); 1059 (109); 1067 (41); 1069 (45a); 1071 (40a); 1075 (40a); 1076 (40a); 1084 (103); 1089 (41); 1096 (82); 1097 (82); 1098 (97); 1132 (37); 1150 (40a); 1156 (66b); 1172 (103); 1176 (103); 1177 (103); 1186 (40a); 1192 (40a); 1222 (37); 1228 (13); 1236 (27); 1238 (65); 1250 (64); 1268 (81b); 1275 (91); 1276 (96); 1287 (51); 1294 (35); 1302 (13); 1305 (64); 1312 (44); 1325 (9); 1327 (96); 1342 (15); 1346 (38); 1347 (47); 1348 (9); 1351 (81a); 1352 (77); 1358 (81b); 1369 (86); 1376 (39a); 1377 (13); 1378 (15); 1379 (26); 1388 (38); 1389 (37); 1392 (77); 1396 (44); 1399 (41); 1415 (81a); 1432 (109); 1462 (40a); 1470 (64); 1525 (53); 1537 (109); 1564 (81a); 1565 (14); 1568 (16); 1569 (81a); 1570 (44); 1573 (18); 1578 (23); 1580 (92); 1597 (44); 1607 (73); 1612 (33); 1634 (45a); 1652 (110); 1657 (58); 1670 (44); 1673 (33); 1711 (54a); 1716 (84); 1739 (88); 1745 (72); 1762 (53); 1763 (75); 1764 (40a); 1779 (40b); 1791 (43); 1795 (41); 1964 (32); 1991 (64); 2466 (50a); 2539 (74); 2543 (50a); 2604 (93); 2616 (54a); 2960 (103); 2978 (37); 2980 (41); 2996 (9); 2998 (9); 3043 (23); 3044 (84); 3045 (65); 3047 (96); 3049 (13); 3058 (96); 3078 (27); 3085 (96); 3110 (14); 3113 (81a); 3120 (102); 3126 (81a); 3144 (86); 3201 (47); 3211 (34a); 3215 (68); 3230 (81b); 3263 (74); 3276 (105); 3284 (77); 3291 (38); 3294 (55); 3305 (54a); 4579 (28); 4580 (97); 4587 (93); 4592 (65); 4593 (25); 4595 (4); 4601 (40a); 4605 (65); 4606 (93); 4608 (65); 4611 (84); 4647 (88); 4696 (81); 4969 (81a) — Judd & Cady 1341 (104).

Kairo 714 (103) — Kalkman 4105 (93); 4308 (109); 4309 (70); 4395 (103); 4398 (103); 4617 (103) — Kalkman & Nicolas 4218 (54a); 4220 (46); 4223 (50b) — Kalkman & Tissing 4260 (65) — Kanis 1406 (46) — Katler s.n., 6/1985 (93) — Kew cult.: s.n., 1965 (35); s.n., 1982 (35); s.n. (Bowden, 1988 (34a) — Keysser 6 (66b) — Kirk 1406 (1) — Kloss s.n., 1913 (17); s.n. (40b); s.n. (103) s.n., 8/1/1913 (77) — de Kock 12 (29); 130 (66c); 142 (66c); 202 (110) — Korthals s.n. (HLB 904.44-48) (50a) — Korthals s.n. (HLB 904.44-49) (50a) — Kostermans 2301 (103) — Kostermans & Soegeng 694 (107); 736 (13); 770 (13); 763a (13); 765a (13).

LAE series: (Stevens) 50309 (74); 51028 (38); 51110 (84); (Stevens & Veldkamp) 54411 (78); (Leach) 56153 (40a); (Kerenga & Crutwell) 56678 (81a); (Kerenga & Baker) 56903 (30); (Stevens) 58101 (40a); (Stevens & Isles) 58379 (97); (Vinas & Waikabu) 59401 (39a); 59489 (45a); (Croft et al.) 60829 (77); 60830 (77 & 84 mixed); (Clunie & Katik) 63309 (38); (Croft & Lelean) 65813 (39a); (Barker & Wai

kabu 66894 (78); (Vinas) 67012 (103); 67044 (66b); (Vinas & Waikabu) 67054 (29); 67057 (49); (Barker & Umba) 67311 (78); (Benjamin) 67858 (40a); 67880 (19); (Croft et al.) 68001 (103); (Croft & Marsh) 71242 (40a); 71245 (37); (Sohmer & Kerenga) 75223 (109); (Kerenga) 77586 (109) — Lam 1347 (11); 1440 (14); 1493 (12); 1539 (54a); 1541 (103); 1618 (108); 1689 (108); 1767 (103); 1900 (13); 1952 (103); 2010 (108) — Lavarack s.n. (104) — Ledermann 10123 (107) — Leiden cult. 21120 (104); 22462 (93); 22467 (84); 22480 (57); 22484 (84); 22491 (93); 22493 (37); 22501 (68); 22507 (66b); 22544 (81a); 22558 (81a); 22561 (97); 22590 (93); 26045 (81a); 28105 (84); 30400 (34b); 30423 (64); 31401 (65); 31405 (109); 31411 (65); 31445 (81a); 31482 (36); 31557 (25); 31614 (18); 31629 (68); 31640 (54a); 31698 (11); 31719a (81a); 31732 (81a); 31734 (110); 31738 (14); 31751 (39b); 31753 (39b); 31827 (81a); 31872 (110); 31875 (58); 31877 (58); 31917 (67); 31920 (46); 31958 (66c); 31962 (54a); 31988 (81a); 31998 (14); 32033 (46); 32134 (46); 32188 (39b); 32260 (66c); 32280 (58); 913110 (66a); 913166 (50a) — Lewis & McDonagh 25 (34a); 28 (32); 32 (47); 46 (32); 61 (34a); 65 (32); 107 (34a); 131 (34a) — Lisowski 55580 (45a) — Longman s.n., 1917 (104) — Lowe, Maclehose & Rendell 15f (39a); 16c (109) — Lörzing 256 (50a).

Maiden 274 (104) — Mason 98 (30); 108 (88); 224 (40b); 1864 (30); 2121 (40b); s.n., 1954 (58); s.n., 1956 (58) — Mayr 468 (25); 539 (89); 569 (40a); 602 (25) — McKee 4023 (74); 15347 (7); 15611 (7); 19189 (7); 30191 (7); 32088 (34a); 34441 (1); 35162 (34a); 42855 (7); 43125 (1); 43191 (7); 43255 (7) — McLennan 34 (44) — McPherson 5655 (7) — Melville 587 (104); 588 (104); 3393 (104); 3596 (104) — Micholitz s.n., 1898 (103) — Millar 1293 (43) — Mitchell 7 (40a) — Moore s.n., 1867 (104) — Morat 5435 (34a) — Moriarty 1028 (6) — Morrison 454 (41); 742 (37); 762 (37); 1114 (66c); 1168 (66c); 1503 (58); s.n., 1896 (104) — Mulder s.n., 2/1989 (50a).

Nedi (Exp. De Haan) 346 (46) — NGF series: (Womersley & Floyd) 6166 (9); (McKee & Floyd) 6325 (81a); (Womersley & Millar) 7800 (109); (Womersley & Good) 9043 (30); (Millar) 9281 (58); (White) 9292 (23); (Womersley) 9389 (44); 9391 (34b); (White & Gray) 10391 (28); (Sayers) 19975 (77); 19977 (84); (Millar) 12028 (46); (Millar & Dockrill) 12055 (46); (Millar) 12132 (35); 12133 (64); 12177 (54a); (Womersley & Thorne) 12604 (109); 12624 (25); 12628 (9); (Millar) 15915 (64); (van Royen) 16038 (37); 16039 (23); 18132 (9); 18132a (62); 18134 (27); 18138 (68); 18145 (22); 18348 (77); 18380 (80); 18400 (80); (Millar & Holttum) 18597 (57); 18619 (39a); (Millar & Garay) 18668 (57); 18669 (39a); 18687 (103); 18699 (38); 18711 (65); 18724 (88); 18734 (81a); 18735 (81a); 18741 (84); (Millar) 18758 (46); (Womersley) 19362 (103); (van Royen) 20258 (103); 20312 (81a); 20313 (30); 20335 (40a); 20336 (23); 20362 (72); 20392 (109); (Henty) 20809 (110); 20868 (34b); 20878 (40a); 20884 (40a); 20892 (14); (Sayers) 21237 (103); 21300 (103); 21405 (103); (Millar) 22554 (55); 22557 (53); 22585 (53); 22708 (103); 22729 (45a); 22757 (39b); 22974 (35); 23131 (39a); 23175 (39a); 23176 (39a); 23195b (109); 23212 (84); 23217 (79); 23274 (14); 23566 (28); (Millar & Sayers) 23738 (66b); 23756 (66b); (Millar) 23888 (14); (Womersley) 24504 (97); 24669 (103); (Henty) 27174 (28); (Frodin) 28266 (65); 28291 (103); (van Royen) 30027 (29); (Ridsdale) 30229 (37); (Apini & Streimann) 30861 (97); (Lavarack & Ridsdale) 31329 (40a); 31399 (40a); (Ridsdale & Lavarack) 31604 (105); (Frodin) 32169 (13); (Ridsdale & Galore) 33199 (45b); (van Royen) 33872 (77); (Ridsdale) 33984 (109); (coll.?) 34171 (64); (Isles & Vinas) 34394 (60); (Isles et al.) 34440 (103); (Croft & Vinas) 34878 (44); (Kairo & Streimann) 35724 (65); (Streimann & Kairo) 35913 (66b); 35917 (103); (Streimann) 35642a (45b); 35855 (103); (Streimann & Kairo) 35925 (35); (Ridsdale) 36702 (40b); (Womersley) 37400 (65); (Millar) 37773 (103); 37777 (66b); (Katik & Taho) 37960 (9); (Millar) 38356 (109); 38369 (103); 38370 (97); 38468 (109); (Henty & Streimann) 38883 (35 & 45a mixed); (Gillison & Kairo) 39105 (97); (Millar) 40624 (97); 40625 (30); 40702 (65); 40765 (30); 40794 (13); (Henty, Isgar & Galore) 41700 (97); (Vandenberg et al.) 42002 (46); (Streimann & Kairo) 42424 (62); 42474 (40a); (Henty, Foreman & Galore) 42755 (103); 42854 (34b); (Womersley) 43589 (97); (Kairo) 45313 (13); (Streimann & Kairo) 45480 (110); 45481 (47); (Womersley) 46465 (28); (Katik) 46722 (103); (Johns & Noble) 47038 (42); (Streimann & Kairo) 47547 (45b); (Kairo) 47670 (64); (Foreman et al.) 48041 (85) — Nicholls 3 (18) — Nicolas 1 (97); 3 (40a).

O'Byrne 125 (11); 265a & b (28); 267 (28); 300 (54a); 302 (53); 305 (66c); 400 (81a); 410 (103); S14 (54a).

Pajmans 1581 (9) — Pancher s.n., 1870 (74) — Philipson & Philipson 3308 (35) — PNH (Eda:o) 5369 (50a) — Powell 232 (66a) — Pulle 887 (103); 940 (103); 940a (103); 962 (109) — Pulle (Franssen & Herderchee Exp.) s.n. (28) — Pullen 5191 (78); 5373 (42); 7983 (40a).

Rachmat 423r (45a); 442 (53) — Raynal 15998 (34a); 17429 (42); 17562 (13); 17620 (103); 17675 (38); 17683 (103); 17688 (103) — RBGE (Roy. Bot. Gard. Edinburgh) cult.: 671744 (41); C4179 (66c); C4199 (54a); C4234 (103); C6392 (84); C7369 (45a); C7458 (65); C7568 (41); C14426 (14); C14431 (71); C14471 (81a); C14475 (9); C14763 (23); C14778 (95); C14785 (68) — RBGE cult.: (Woods) 630444 (35); 682601 (41); C4200 (88); C4666 (41); C4683 (13); C5055 (54a); C5228 (35); C5287 (109); C5380 (66b); C6376 (81a); C6393 (77); C6457 (80); C6488 (72); C7246 (81a); (Argent) C7416 (81a); C7417 (81a); C7418 (81a); C7419 (81a); (Argent) C7851 (38); (Argent) C14420 (81a); (Argent) C14452 (97); (Elworthy) C14455 (103); (Sayers) C14470 (103); (Woods) C14477 (79); (Argent) C14483 (81a); C14485 (73 & 95 mixed); (Woods) C14493 (81a); C14494 (81a) — Rees & Reeve 31 (81a); 83 (99); 147 (53); 179 (71); 186 (85); 187 (81a); 282 (81a); 293 (96); 296 (15); 304 (39a); 323 (103); 326 (37); 327 (43); 366 (28); 400 (88) — Reeve 205 (39a); 207 (96); 322 (39a); 582 (34b); 598 (31); 615 (53); 625 (30); 645 (45b); 683 (81a); 684 (35); 692 (37); 692b (37); 734 (93); 748 (90); 759 (24); 764 (110); 769 (39a); 777 (69); 879 (73); 883 (23); 884 (25); 894 (102); 988 (41); 993 (38); 994 (79); 996 (77); 998 (37); 999 (92); 1015 (103); 1018 (77); 1019 (31); 1031 (92); 1032 (73); 1033 (96); 1050 (94); 1054 (34b); 1056 (96); 1072 (103); 1090 (110); 1095 (31); 1096 (44); 1106 (44); 1110 (14); 1115 (38); 1116 (102); 1175 (54a); 1234 (103); 1302 (23); 1335 (78); 1350 (87); 1384 (91); 1389 (25); 1395 (91); 1396 (79); 1397 (81a); 1454 (103); 1496 (23); 1511 (109); 1571 (13); 1665 (43); 1666 (35); 1711 (46); 1757 (97); 1758 (78); 1787 (81a); 1790 (102); 1841 (14); 1843 (88); 1849 (64); 1890 (43); 1922b (65); 1931 (43); 1957 (106); 2311 (96); 2315 (45a); 2332 (110); 2423 (15); 2501 (18); 2579 (92); 2660 (103); 2663 (44); 2735 (110); 2743 (65); 2856 (34b); 2862 (59); 2898 (103); 3026 (14); 3205 (99); 3502 (35); 3569 (64); 3692 (110); 4228 (81a); 4285 (44); 4356 (76); 4357 (78); 4382 (28); 4389 (21); 4392 (14); 4535 (42); 4653 (57); 4707 (44); 4724 (40b); 4735 (45a); 4780 (14); 5015 (65); 5059 (81b); 5068 (81a); 5104 (38); 5122a (72); 5123 (51); 5772 (109); 5910 (37); 5919 (110); 5920 (46); 6145 (36); 6208 (109); 6220 (42); 6222 (42); 6229 (42); 6241 (109); 6289 (103); 6308 (103); 6338 (36); 6394 (84); 6493 (9); 6576 (44); 6599 (45a); 6608 (40b); 6618 (54a); 6628 (45a); 6638 (9); 6641 (10); 6654 (45a); 6656 (88); 6665 (64); 6752 (45a); 6781 (79); 6789 (15); 6790 (31) — von Römer 155 (28); 435 (46) — van Royen 11446 (109) — van Royen & Sleumer 5934 (22); 6941 (40a); 7897 (109); 8155 (39a) — van Royen, Sleumer & Schram 7689 (25) — RSNH series: (Green) 1177 (34a); (Raynal) 16239 (66a); (McKee) 24162 (32) — Rutten 2239 (52).

Sands 1419 (66c); 1493 (13); 1716 (66b); 1816 (79); 1839 (37); 2305 (40a); 2348 (97); 2558 (97) — Saunders 745 (65) — Sayers 20 (66c) — Schlechter 13924 (32); 13942 (105); 13993 (68); 14047 (109); 14642 (28); 15492 (50a); 16051 (105); 16379 (65); 16475 (103); 16651 (105); 16716 (47); 16723 (68); 16794 (28); 16967 (33); 17016 (35); 17196 (64); 17273 (58); 17334 (65); 17352 (103); 17574 (66c); 18136 (25); 18237 (30); 18497 (28); 18532 (41); 18573 (22); 18585 (93); 18684 (40a); 18735 (80); 18745 (97); 18770 (67); 18884 (109); 18989 (103); 19005 (106); 19007 (33); 19244 (70); 19562 (11); 19709 (93); 19822 (109); 19895 (35); 19904 (103); 20080 (48); 20097 (18); 20282 (109); 20326 (110); 20329 (33) — Schmid 3982 (47) — Schmutz 4243 (50a); 5598 (50a) — Schneider s.n. (3) — Schodde 1585 (13); 3858 (54b); 5444 (40a) — Schuiteman 1 (109); 4 (109); 7 (81a); 12 (110); 30 (109); 37 (37); 45 (37) — Schuiteman, Mulder & Vogel 25 (65); 26 (45a); 37 (42); 41 (103); 49 (59); 71 (50a) — Selling 222 (7) — Simmonds s.n., 10/1909 (3); s.n., 1951 (74) — Sitanala 9 (66c) — Smith, A.C. 8266b (66a) — Smith, J.J. 427 (50a) — Soengeng 613 (40a) — van Steenis 2705 (50a) — Sterly 1689 (62); 1707 (42); 80581 (81a); 80635 (65) — Stewart 2407 (104) — Stewart s.n., 1873 (4) — Suprin 301 (34a).

Taylor 1489 (53) — Toxopeus n.Be0 (40b); s.n. (40b).

UPNG series: (Dodd) E16 (68); (Millar) 1317 (54a).

Veillon 3581 (7); 5767 (7) — Veldkamp 6807 (39a); 6838 (45a) — Versteeg 1295 (54a); 1333 (109); 1449 (18); 1511 (45a); 1514 (68); 1537 (47); 1562 (109) — Vicary s.n., 1836 (4) — Villegente 3 (7); 4 (1); s.n., 18/4/1990 (74) — Vinas 101 (103) — Vink 16570 (37); 17002 (103); 17547 (9).

Weinthal s.n., 18/11/1930 (4); s.n., 1932 (104); s.n., 16/12/1935 (3) — Wenzel 659 (66c); 837 (66c) — Wheatley 75 (47); 83 (34a); 248 (66a); 301 (34a); 361 (34a); 494 (34a) — Whistler 3735 (66a); 3816 (66a) — Whitmee s.n., 3/1878 (66a) — Wickison 64a (103); 64b (106); 76 (40a); 134a (18); 225 (40a); s.n., 1986 (60); s.n. (103) — de Wilde 1178 (103) — Wilkie & Dockrill s.n., 15/10/1961 (8) — Wilkie in Hunt 546 (8) — Wilkie s.n., 9/1946 (8) — Willmott s.n., 1911 (58) — Womersley 12 (30); 16 (81a) — Woods 2043 (109) — Woods & Black 1190 (35) — Wools in Hb. Mueller s.n., 1873 (104).